

Volume 2A Appendices

- Appendix 1 - Correspondence to EirGrid from SEM Committee (April 30th 2013)
- Appendix 2 - Electricity Transmission Costing Study – Parsons Brinckerhoff, in association with Cable Consulting International Ltd. (January 2012 with errata published in April 2012)
- Appendix 3 - Approach to the Development of Electricity Transmission Lines EirGrid (2012)
- Appendix 4 - EU Law and Policy
- Appendix 5 - Policy Review of County Development Plans
- Appendix 6 - Research References - High Voltage Overhead Line Infrastructure and Property Values

APPENDIX 1

**Correspondence to EirGrid from SEM Committee,
dated 30th April 2013**

30th April 2013

John Fitzgerald
Director, Grid Development
Eirgrid plc
The Oval, Shelbourne Road
Dublin 4

David de Cassesres
NIE Ltd
120 Malone Road
Belfast
BT9 5HT

Dear John/ David

Re. North South 400kV Interconnection Development

The SEM Committee wishes to thank EirGrid, SONI and NIE (the Companies) for the update provided to the Committee on the progress made by the Companies in the development of the proposed 400kV second North South interconnector last November. At that meeting the Committee articulated its view of the importance of this project as a critical component of a fully functioning, efficient electricity market on the island of Ireland and one which will play a significant role in helping to integrate renewable generation in both Ireland and Northern Ireland.

Since then EirGrid and SONI have published the Generation Capacity Statement 2013 - 2022 which shows increasingly tight supply margins in Northern Ireland post 2016 but which would be mitigated by the development of a second North South interconnector and you have also advised that as per your most recent studies, under the assumptions employed, the benefits in terms of reduced production costs and enhanced capacity sharing which would result from the project's development will be of the order of €20m per annum rising to closer to €40m per annum in the medium term.

All of the above point to the relevance of the second North South interconnector to the successful implementation of the policy objectives of competitiveness, sustainability and security of supply in both Ireland and Northern Ireland and the necessity to advance and deliver this project, and to not only deliver it but deliver it as a matter of urgency. The SEM Committee is charged with protecting the interests of electricity customers on the island of Ireland. To that end the Committee is concerned that the absence of vital infrastructure is costing customers.

Of course the project must not only be progressed quickly but also cost effectively. The Committee understands from the Irish government review that the cost for the undergrounding of the project would be significantly higher than the AC overhead line construction employed elsewhere in Europe. The regulatory authorities would therefore be of the view that customers should not be expected to pay for any unnecessary costs associated with undergrounding of the cables given there would be no enhancement in service.

The Committee therefore emphasises the need for the timely progress of the project and notes that it is also important that all statutory, environmental and local considerations are taken into account in bringing the project forward.

The Committee is happy that you show or provide a copy of this letter of support for the project to any such body as you believe may be necessary or beneficial in advancing the project and achieving the necessary consents. The Committee would ask that the Companies keep the Committee abreast of progress.

Yours sincerely

A handwritten signature in blue ink that reads "Alan Rainey". The signature is written in a cursive style with a long, sweeping underline that extends to the right.

Alan Rainey
Chairman, SEM Committee

APPENDIX 2

Electricity Transmission Costing Study – Parsons Brinckerhoff, in association with Cable Consulting International Ltd.

(January 2012 with errata published in April 2012)

Electricity Transmission Costing Study

An Independent Report
Endorsed by the Institution of
Engineering & Technology

Issued 31st January 2012
With errata April 2012

**PARSONS
BRINCKERHOFF**

In association with:

CCI Cable Consulting International Ltd



Foreword from the Institution of Engineering & Technology[†]

The availability of a secure and reliable electricity supply system is a prerequisite for a developed country, and the UK has enjoyed a long period of high quality electrical energy supply. Many of the key decisions relating to the structure and operation of the supply network were taken around fifty years ago and, until recently, the basic shape of that system has remained largely unchanged. The UK now faces a fundamental shift in the way electricity is generated and supplied through the transmission and distribution network. New generating sources are becoming increasingly deployed throughout the network at all voltages, with inherent system control challenges. Large-scale renewable energy generation schemes are currently being developed and more are planned, often in locations that present challenges by their remoteness from the existing high voltage transmission network. The need to extend and reinforce the network is therefore pressing if the UK is to exploit fully these new sources.

Naturally new electricity supply infrastructure, especially in sensitive areas in the country, is likely to be controversial and will be subject to detailed planning scrutiny. Any network reinforcement or new connection can take a number of different forms, the most common of which has been the use of overhead transmission lines, but other technical solutions exist. The costs of these solutions can, however, vary considerably, not just by small percentages but by multiples of the cheapest option.

The purpose of this report is therefore to provide the best estimate of the relative costs of the various technologies currently available for high voltage network enhancement at significant power levels, such that the debate around the acceptability in planning terms can be based on an accredited view of the relative costs. The cost analysis has been derived from data supplied by manufacturers, installers and owners around the world, relating to actual installations of the various technologies, a process which has necessitated professional judgement to bring the diverse sets of data to a common base. The conclusions are clearly given at this point in time, and cannot reliably be projected far into the future because technological developments could reduce some elements of the costs. Each proposed scheme could also present very different challenges and so the report has included an indication of the variability of each cost component. It is not, however, reasonable to assume that for comparison purposes the set of lowest costs could be compared with the corresponding highest costs for an alternative.

The report has been written to be accessible to as wide an audience as possible but the topic is inherently complex. The Appendices contain a basic explanation of the key aspects that affect the whole life costs of the particular technology, the characteristics of which are also presented. The main body of the report uses a graphical representation to present and compare the costs of each transmission technology and, as will be apparent to the reader, these can vary considerably, making some technologies unviable in particular instances. The report does not attempt to quantify environmental implications of any of the technologies.

The Institution of Engineering & Technology has overseen the preparation of the report through a Project Board established specifically for the purpose and comprising senior figures with expertise in electrical power systems. Details of Board membership are given below. Parsons Brinckerhoff has been responsible for the collection of data and preparation of the report, the conclusions of which have been endorsed by the IET.

Prof. M J H Sterling, Chairman of the Project Board

†The Institution of Engineering and Technology

The Institution of Engineering and Technology (IET) is a global organisation with over 150,000 members representing a vast range of engineering and technology fields. Our primary aims are to provide a global knowledge network promoting the exchange of ideas and to enhance the positive role of science, engineering and technology between business, academia, governments and professional bodies, and to address challenges that face society in the future.

As engineering and technology become increasingly interdisciplinary, global and inclusive, the Institution of Engineering and Technology reflects that progression and welcomes involvement from, and communication between, all sectors of science, engineering and technology.

The Institution of Engineering and Technology is a not-for-profit organisation, registered as a charity in the UK.

For more information, please visit: <http://www.theiet.org>

The Institution of Engineering and Technology is registered as a Charity in England & Wales (no. 211014) and Scotland (no. SC038698).

Project Board Membership

| | |
|--|--|
| Prof. M J H Sterling BEng, PhD, DEng, CEng, FREng, FAEng(CZ), FIEE, FInstMC, CCMI, FRSA, Hon FInstMC, Hon FIET | Past President IET |
| Dr M Kennedy CBE, FREng, FRSE | Past President IET |
| Prof. J Loughhead OBE, FREng, CEng, FIET, FCGI | Past President IET |
| Mr M Winfield BSc(Hons), MBA, CEng, MIET | Parsons Brinckerhoff |
| Mr S Lloyd B.Tech, MIET | Cable Consulting International |
| Mr P Davies BEng, CEng, MIET | Institution of Engineering & Technology |

Commissioning organisations

| | |
|------------|---|
| Mr T Luff | Department for Energy & Climate Change |
| Mr S Griew | National Grid |

The commissioning organisations were excluded from the preparation of the report and consideration of its conclusions, except for a late review for factual accuracy by National Grid.

Disclaimer

In preparing this report, Parsons Brinckerhoff Ltd (PB) has relied upon transmission cost information provided to PB by equipment suppliers, equipment owners, or other electricity supply industry organisations. PB has sourced, examined, analysed, and aggregated this information, as appropriate, in the interests of balance and clarity for planning purposes. However, the proper application of transmission technology is complex, and the cost estimates contained here can only act as a guide to the overall planning process. PB thus makes no warranties or guarantees, actual or implied, related to the ultimate commercial, technical, economic, or financial performance of projects which reference this report.

Executive summary

The transmission network

The electricity transmission network for England and Wales provides high voltage connections between the many electricity generators around the country and the lower voltage distribution systems that deliver electricity to our homes and workplaces.

Over the next few years, the England and Wales high voltage transmission network will need to be reinforced and extended to connect a number of new sources of electricity, principally wind farms, nuclear power stations and interconnectors to other European networks. National Grid, which is licensed by Ofgem to own the transmission network in England and Wales, and to operate the transmission network across Great Britain, thus needs to plan these developments in a safe, efficient and economic manner, in accordance with its licence.

Transmission costs

The ongoing cost of the transmission network in England and Wales is made up from the build costs of new equipment and the ongoing operational costs (including maintenance and losses) of these assets. Both of these types of cost, which together make up the “lifetime cost”, need to be supported by the electricity consumer and are the main focus of this study.

Social and environmental costs may also be attributed to transmission but, whilst acknowledging the potential generic impacts of transmission in these areas, it is not the purpose of this study to examine or evaluate them.

Planning and the Infrastructure Planning Commission

Virtually all new transmission development in the England and Wales is subject to planning legislation, and all new overhead transmission lines also require consent from the Infrastructure Planning Commission (IPC). It is to satisfy the requirements of the IPC for information on the costs of feasible transmission options, that this report has been written.

The costs

The cost estimates in this study relate to technology types and ratings currently in use on the England and Wales transmission network, including: overhead line, underground cable and gas insulated line – all connected at 400kV alternating current – and high voltage direct current underground and subsea cable – connected at 320kV and 400kV. This report presents estimates of build costs and operating costs for each transmission technology, to allow comparisons on a like-for-like basis – that is, similar transfer capacities over similar distances on similar terrain. The estimates, particularly those for the underground options, are based upon terrain examples, but there is no recommendation within this report, either explicit or implied, regarding the application of any particular transmission technology in any part of England and Wales.

Main findings

From this study we wish to highlight the following main findings:

- No one technology can cover, or is appropriate in, every circumstance, and thus financial cost cannot be used as the only factor in the choice of one technology over another in a given application.
- Costs per kilometre, for all technologies, tend to fall with increasing route length, and tend to rise with circuit capacity.
- For typical National Grid system circuit loadings, the inclusion of operating costs in the technology comparisons does not significantly affect the overall differences in cost between the technologies. However, they do affect the cost ratios considerably, rendering the ratios a misleading measure when making investment decisions.
- Overhead line (OHL) is the cheapest transmission technology for any given route length or circuit capacity, with the lifetime cost estimates varying between £2.2m and £4.2m per kilometre; however, OHL losses are the most sensitive to circuit loading.
- Underground cable (UGC), direct buried, is the next cheapest technology after overhead line, for any given route length or circuit capacity. It thus also represents the least expensive underground technology, with the lifetime cost estimates varying between £10.2m and £24.1m per kilometre.
- For the options using a deep tunnel, the largest single cost element is invariably the tunnel itself, with costs per kilometre ranging from £12.9m to £23.9m per kilometre, depending upon overall tunnel length.
- The 75km high voltage direct current (HVDC) connections are estimated to cost between £13.4m and £31.8m per km, and are thus more expensive than the equivalent overhead or direct buried transmission options. However, long HVDC connections are proportionally more efficient than short connections.
- Undergrounded gas insulated line (GIL) technology is generally estimated to be higher cost (ranging between £13.1m and £16.2m per kilometre) than the lowest rating ("Lo") underground cable studied (£10.6m to £12.8m per kilometre), although the GIL equipment does have a somewhat higher rating than the comparable UGC. This factor, along with any future experience of the technology in the UK, may change the effective costs per kilometre, and this situation should be kept under review.

We also offer two notes of caution:

- Cost ratios are volatile, and no single cost ratio comparing overhead line costs with those of another technology adequately conveys the costs of the different technologies on a given project. Use of financial cost comparisons, rather than cost ratios, are thus recommended when making investment decisions.
- The transmission technologies may not all be able to use the same route as each other, so circuit lengths may vary between technologies for a given application. We therefore recommend that actual practicable routes be identified when comparing total lifetime costs of each technology for specific investment decisions.

Contents

| | |
|--|-----|
| Foreword from the Institution of Engineering & Technology [†] | iii |
| Executive summary | vii |
| Contents..... | xi |
| List of figures | xii |
| 1 Acknowledgements | 1 |
| 2 Abbreviations and acronyms..... | 3 |
| 3 Background | 5 |
| 4 Introduction..... | 7 |
| 5 Scope and methodology | 9 |
| 6 Introduction to the lifetime cost charts | 15 |
| 7 Lifetime cost charts | 21 |
| 8 Summary bar charts and tables | 115 |
| 9 Main findings | 125 |

The order of the cost charts in Section 7 is as follows:

Overhead lines

Underground cables – direct-buried

Underground cables – in tunnels

Gas insulated lines – direct buried

GIL – in tunnels

HVDC – CSC and subsea cable

HVDC – VSC and subsea cable

List of figures

| | |
|--|-----|
| Figure 1 – The seven sets of transmission technology cost assessments..... | 10 |
| Figure 2 – Twin conductor bundle overhead line | 21 |
| Figure 3 – Dartford Crossing cable tunnel..... | 41 |
| Figure 4 – Short section of gas insulated line, by Siemens | 79 |
| Figure 5 – Ballycronan More 500MW CSC converter station | 105 |
| Figure 6 – 3km route length – lifetime costs per km | 116 |
| Figure 7 – 15km route length – lifetime costs per km | 117 |
| Figure 8 – 75km route length – lifetime costs per km | 118 |

List of Tables

| | |
|---|-----|
| Table 1 – Technology cost differences and ratios: 3km route length | 121 |
| Table 2 – Technology cost differences and ratios: 15km route length | 122 |
| Table 3 – Technology cost differences and ratios: 75km route length | 123 |

List of Appendices



| | |
|------------|---|
| Appendix A | Final terms of reference |
| Appendix B | Consultant team members |
| Appendix C | Costing methodology and estimates |
| Appendix D | Losses |
| Appendix E | Technology – overhead lines |
| Appendix F | Technology – underground cables |
| Appendix G | Technology – subsea cables |
| Appendix H | Technology – HVDC converter stations |
| Appendix I | Technology – gas insulated lines |
| Appendix J | Technology – tunnels for UGC and GIL |
| Appendix K | ENTSO-E – Europacable joint paper |
| Appendix L | Planning and environment |
| Appendix M | Bibliography |
| Appendix N | Letters sent by DECC |
| Appendix O | List of organisations approached |
| Appendix P | December 2010 stakeholder workshop contributions received |
| Appendix Q | Abbreviations and acronyms |

1 Acknowledgements

A good portion of our work has been to bring the information from a diverse range of sources onto a common platform in order that we can make like-for-like cost comparisons. The quality of this work has thus depended as much upon our contributors as ourselves. We gratefully acknowledge the many and varied contributions from a variety of organisations, including transmission system operators, equipment suppliers, contractors and other stakeholders. A full list of those approached for contributions to this report is provided in Appendix O.

Prepared by
Parsons Brinckerhoff
Westbrook Mills, Godalming, Surrey GU7 2AZ
www.pbworld.com

Document History and Status

| Report Issue | Date of Issue | Prepared By: | Checked By: | Approved By: |
|--------------|---------------|---|---|---|
| 1.1 | 20 Feb 12 | David Thorn | Mark Winfield | Sean McGoldrick |
| 1 | 31 Jan 12 | Mark Winfield Simon Lloyd David Thorn Martin Safranek Ian Robson Allan Burns Rory McKimm Terry Howes | Mark Denny  Andy Pearce  | Sean McGoldrick  |

2 Abbreviations and acronyms

The following acronyms are used within this report. We have placed their explanations both at the beginning and at the end of this document for the reader's easy reference.

| | |
|---------|---|
| AC | alternating current |
| ACCC | aluminium composite core conductors |
| ACSR | aluminium conductor, steel reinforced |
| CIGRE | the International Council on Large Electric Systems |
| CLF | circuit loading factor |
| CSC | HVDC current source converter |
| DC | direct current |
| DCO | Development Consent Order |
| DECC | Department of Energy and Climate Change |
| EHV | extra high voltage |
| EIA | environmental impact assessment |
| EPBM | earth pressure balanced machine – one type of TBM |
| EPC | engineer, procure and construct |
| GIB | gas insulated busbar |
| GIL | gas insulated line |
| GW | gigawatt (one million kW of power) |
| GZTACSR | gap-type ZT aluminium alloy conductor, steel reinforced |
| HVDC | high voltage direct current |
| IET | Institution of Engineering & Technology |
| IPC | Infrastructure Planning Commission |
| km | kilometre |
| kV | kilovolt (1000 volts) |
| kW | kilowatt (1000 watts of power) |
| L6 | L6, L8 and L12, are three tower designs currently used by National Grid |
| LCC | line commutated converter (also known as CSC) |
| LF | load factor |
| LLF | loss load factor |
| LRMC | long run marginal cost of generation |
| MI | mass impregnated type transmission cables |
| MIPU | Major Infrastructure Planning Unit |
| MVA | megavolt-amperes (a measure of transmission capacity) |
| MW | megawatt (1000 kW of power) |
| NSIP | Nationally Significant Infrastructure Projects |
| OHL | overhead line |
| OPGW | optical fibre ground wires |
| PPL | peak power losses |
| PV | present value |
| SEC | cable sealing-end compound |
| SRMC | short run marginal cost of generation |
| TBM | tunnel boring machine |
| TO | transmission owner |
| ToR | terms of reference |
| TSO | transmission system operator |
| UGC | underground cable |
| VSC | HVDC voltage source converter |
| XLPE | cross-linked polyethylene |

3 Background

The transmission network

The electricity transmission network for England & Wales provides high voltage connections between the many electricity generators around the country and the lower voltage distribution systems that deliver electricity to our homes and workplaces. The transmission network generally provides more than one path along which the electricity can flow so that, during equipment maintenance, or in the event of an equipment fault, a serviceable connection can still be provided for each generator and each distribution network connection point, thus preserving the 24-hours-per-day integrity of our electricity supply.

Over the next few years, the England and Wales high voltage transmission network will need to be reinforced and extended to connect a number of new sources of electricity, principally wind farms, nuclear power stations and interconnectors to other European networks. National Grid, which is licensed by Ofgem to own the transmission network in England and Wales, and to operate the transmission network across Great Britain, thus needs to plan these developments in a safe, efficient and economic manner, in accordance with its licence.

Transmission technologies

There are a number of transmission technologies available to cover the various transmission requirements placed upon National Grid by its licence; however, they have different characteristics and costs. Traditionally, overhead lines have provided the lowest cost method of covering medium distances in non-urban environments, whilst underground cables often provided the only practical transmission option in built-up areas. High voltage direct current can provide the most economic solution when covering great distances, or when significant lengths of underwater connection are to be made.

More recently, gas insulated lines – which have not been used significantly to date in the UK – have provided an alternative underground solution where particular technical characteristics are vital to the network or where they offer a cost advantage.

In certain circumstances, either of the underground technologies (cables and gas insulated lines) may be placed in a tunnel rather than directly buried in a trench.

Transmission costs

The cost of sustaining the transmission network in England and Wales comprises the build costs of new equipment and the ongoing operational costs (including maintenance and losses) of these assets. Both of these types of cost need to be supported by the electricity consumer through the electricity billing mechanisms, and their comparison is the main focus of this study.

National Grid also builds and operates a number of control, communication and measurement systems to support the transmission network, but they are generally common between the transmission technologies and are not considered in this study.

However, there are other costs – social and environmental – which may be attributed to transmission connections (not all of which are easily converted to monetary values). Some of these costs relate to location-specific factors, such as disruption to the community, loss of visual amenity, property devaluation and concerns about electromagnetic fields. It is not the purpose of this study to examine or evaluate social and environmental impacts of these technologies, but it does acknowledge the potential generic impacts that each may have.

Planning and the Infrastructure Planning Commission

Whilst it is difficult to place a monetary value against social and environmental costs, it is possible to estimate the cost incurred in obtaining planning permission for a transmission development, and it is within the planning process that these social and environmental requirements need to met.

Virtually all new transmission development in the England and Wales is subject to planning legislation, and this would normally include consideration of, for example, local development plans and impact on the environment. However, in England and Wales, all new overhead transmission lines currently also require consent from the Infrastructure Planning Commission (IPC).

It is to satisfy the requirements of the IPC for information on the costs of feasible transmission options, that this report has been written.

4 Introduction

Independent assessment of transmission costs

Under the provisions of the Planning Act 2008, all new overhead transmission connections must have approval from the Infrastructure Planning Commission (IPC) or, from April 2012, when the Localism Bill takes effect, from the Secretary of State. To inform these planning decisions, Sir Michael Pitt, chair of the IPC, has asked for a study to be carried out to establish an independent and authoritative view on the comparative costs of undergrounding and subsea cabling versus using overhead power lines. This approach is supported by the Department of Energy and Climate Change (DECC).

The accuracy of a transmission cost estimate improves with detailed knowledge of:

- the transmission load,
- the available transmission technologies and their constraints,
- local development plans and planning policy, and
- local social and environmental constraints.

The cost of applying any transmission technology may vary considerably according to any or all of these factors, so by presenting the generic costs of several transmission technologies using independent, like-for-like comparisons, we hope to inform the IPC's decision-making on future transmission applications.

It is our intention to make the costing information accessible to as wide an audience as possible in this main body of the report, with minimal reference to detailed technical characteristics of the transmission equipment. Further information on these latter aspects are to be found in the appendices.

We note that, during late 2010 and early 2011, work was undertaken by another firm of consultants on comparative costs of different transmission technologies, and factors that influence those costs. A package of information from this exercise was made available to the Parsons Brinckerhoff team. At the start of our work, we contacted individuals and organisations that were known to have contributed to the 2010 study, and invited them to update their contributions.

A copy of the revised terms of reference for this latest study may be found in Appendix A.

Layout of the report

This document consists of:

- background, and this present Introduction,
- introduction to and series of lifetime cost charts, providing estimates of transmission technology costs (see Sections 6 and 7),
- comparison charts and tables, where the costs of the various technologies are brought together and compared (see Section 8),
- main findings (see Section 9), and

- Appendices (A–Q) that provide further information on the technologies and their costs and additional information regarding the preparation of this report.

5 Scope and methodology

Technology scope

The cost estimates in this study mainly relate to technology types and ratings currently in use on the England and Wales transmission network. However, there are one or two exceptions to this, principally in the GIL and HVDC technologies. Firstly, regarding GIL, there is less than 1km of three-phase circuit installed at 400kV in England and Wales at present (none of it directly buried), but we have included our best cost estimates on this technology since the market may encourage its greater use, in certain circumstances, in future.

In the second area, HVDC, we recognise that the advances in technology are allowing ever-larger transmission circuits¹ to be built, so we have based our costings upon 1500MW units even though, to date, no converter of this size exists in the UK. This size of converter offers the cheapest way of providing an HVDC like-for-like comparison with the AC double circuits considered in this study, though we understand that larger converters have already been offered into the market. HVDC is thus one of the fastest-developing areas in transmission technology today, and our costing estimates should be reviewed as the larger converters establish a good performance track record.

Our lifetime cost estimates cover the 400kV double circuit transmission technology options listed below, further details of which are provided in the indicated appendices:

- overhead line (OHL), detailed in Appendix E
- direct-buried underground cable (UGC), detailed in Appendix F
- UGC in a tunnel, detailed in Appendices F & J
- direct-buried gas insulated line (GIL), detailed in Appendix I
- GIL in a tunnel, detailed in Appendices I & J
- HVDC – CSC with subsea cable, detailed in Appendices G & H
- HVDC – VSC with subsea cable, detailed in Appendices G & H

Notes:

(i) Multi-terminal and overhead HVDC connections, and subsea AC connections, are outside of the scope of this study, as are single circuit options² for AC and monopole designs for HVDC.

(ii) Where we have costed UGC and GIL in tunnels, the cost estimates have been based on a 4m diameter bored tunnel capable of accommodating at least two double circuits.

The above list of technology options is also presented graphically in the following Figure 1:

¹ Transmission circuits using HVDC technology are commonly referred to as bipoles.

² Single circuit options represent relatively inefficient use of a transmission corridor, and are non-standard in the UK.

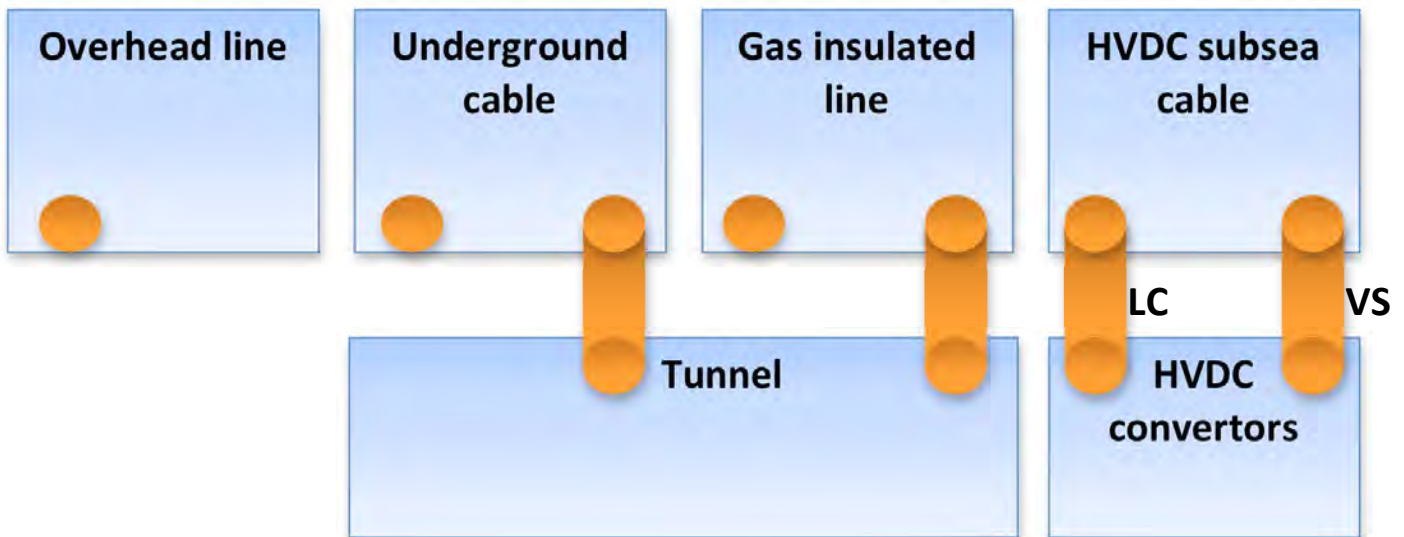

Figure 1 – The seven sets of transmission technology cost assessments

In this graphic, each orange marker represents one set of cost assessments.

Route lengths

We have adopted just three basic route lengths for our estimates and, by flexing these with sensitivity analyses, we believe that they will cover the vast majority of proposed new connection route lengths. The basic route lengths adopted were:

- 3km (3km flexed $\pm 50\%$ covers the range 1.5–4.5km)
- 15km (15km flexed $\pm 50\%$ covers the range 7.5–22.5km)
- 75km (75km flexed $\pm 50\%$ covers the range 37.5–112.5km)

Double circuit capacities

The transmission circuit ratings we have studied are specified in Table 1 of Appendix A – final terms of reference. For ease of reference later in this report we have allocated the following three short-form labels for the lowest, middle and highest-rated circuits:

- **Lo** 3190MVA AC (that is, two AC circuits, each of 1595MVA) or 3000MW DC (that is, two DC bipoles each of 1500MW continuous rating),
- **Med** 6380MVA AC (that is, two AC circuits, each of 3190MVA), or 6000MW DC (that is, four DC bipoles each of 1500MW continuous rating), and
- **Hi** 6930MVA AC (that is, two AC circuits, each of 3465MVA).

The reader may note that the Lo ratings are half those of Med, and that these two levels cover most National Grid circuit rating requirements. However, a Hi rating has been included since, although it is quite similar to the Med rating, it corresponds to the limit of National Grid's switchgear capacity, and may be used on those occasions where the highest possible rating is required. Since Med and Hi are so similar, no separate HVDC subsea connection has been considered for the Hi rating.

Methodology

Having established the terms and scope of the study, established case study areas to fix terrain-based assumptions, and identified and contacted potential sources of data, we agreed with the Project Board a report structure, the aim of which was to present complex results in an accessible manner to a wide audience.

Data gathering

To gather the most current data, we contacted equipment suppliers, installers, manufacturers and equipment owners, and referenced material from learned publications. In all, we contacted 95 organisations or individuals (see Appendix O), of which we anticipated over 60 might be able to respond with technical or costing information.

The responses to our requests varied greatly in quantity, and in level of detail, and eventually we continued to seek data input in some technical areas until December 2011. The most complete/detailed responses concerned overhead line and underground cable materials, along with underground cable installation; less detail was made available in some other areas. In the event, we finally received substantive responses from some 24 sources.

Every transmission project in the UK requires appropriate consultation with interested parties, and the costs of stakeholder consultation and environmental surveys and impact mitigation, along with other legal, administrative and project management costs, are borne by the transmission owner. We thus discussed these project launch and management costs with National Grid, and included them in our estimates, in accordance with the terms of reference. These costs are separately identified in the report's tables and lifetime cost analyses as "project launch and management" costs.

No substantial information was obtained to assist in establishing how, if at all, project launch and management costs vary across Europe. However, we hope that this report will not only be of assistance in the UK, but may also be of interest to European transmission operators, who may feel able to contribute in future, should the study be periodically reviewed.

Basis of cost comparisons

The equipment costs presented in this document are 4th quarter 2011 estimates. Our cost estimates identify both the equipment procurement and installation costs, and those costs which are incurred by a transmission operator both before and during the life of the equipment.

The costs of new transmission equipment installations are sensitive to many factors, including the transmission capacity required, the terrain through which the connection runs, world metal prices, the cost of labour and the currently prevailing transmission equipment market itself. We have tried to address the most significant of these variables using sensitivity analyses.

Dealing with the information we received, however, was not without its challenges. We were aware of the risk that some information could have been provided to the study with a bias that either exaggerated or understated likely market costs and, where data was sparse, there was the added complication of presenting the information without compromising commercial confidentialities. To overcome these problems, rather than simply accepting raw data for the study, we strove to test, contrast and compare the data, qualifying or adjusting it with the experience and professional judgement of the team members (see Appendix B for a list of team members). We have placed confidential data within ranges or averages, with the option to omit it where confidentiality might otherwise be broken. In these ways we maximised the probability that the cost estimates were reasonable, publishable, comparable between technologies, and presented without bias.

Since commodity prices, particularly metal prices, can affect transmission equipment costs, we have tried to indicate the sensitivity of the lifetime costs to relevant metal prices. We hope that this approach will offer some measure of future-proofing to our results.

Regarding operating costs, we have assumed that all technologies have a standard annual cost of maintenance and losses, and that HVDC has, in addition, a major mid-life refurbishment. These future costs have all been brought to a present value using discounted cash flow calculations with a 6.25% discount rate. Appendix C has further details on this, and includes a table outlining the effect of other discount rates on these calculations.

Further technical developments, including new materials, equipment designs, emerging technologies and other market developments, are all likely to modify transmission costs in the future. It is not easy to future-proof against these factors; however, in the technology description appendices we mention some possible near-term developments that may affect equipment costs.

Given the pricing uncertainties, it is recommended that the transmission technologies, their costs and our assumptions are all reviewed periodically and updated when it is considered that the sensitivity factors given in this report no longer offer the required estimating clarity.

How this report may be used, and its limitations

This report provides cost estimates for transmission technologies on a like-for-like basis – that is, similar transfer capacities over similar distances on similar terrain. However, each technology has its own merits and limitations, and inevitably there are potential transmission applications where some technologies will not be viable – for example, there is no point considering the construction of a new double circuit 400kV overhead line through a heavily built-up area. To allow a like-for-like comparison, therefore, we have chosen case study examples where the land-based technologies (particularly the underground ones) may be compared over a reasonable mix of rural and urban terrain, and where a subsea option may also be feasible.

The cost comparison estimates are based upon a set of “straightforward” terrain examples presented in the case studies (see Appendix C). However, the reader should note that this study is purely a costing exercise, and neither these case studies, nor any other part of the report, should be taken as recommendation of a particular technology for a specific application or location.

A substantial portion of the UK transmission network has existed for over forty years, and thus some new projects may include an element of decommissioning of old equipment. These costs are clearly location-dependent, and this study does not attempt to cost the decommissioning of old electricity supply installations.

Although our cost comparison estimates have been based upon “straightforward” terrain examples, we recognise that readers will be interested in comparing transmission prices over a variety of circumstances. To aid in this situation we have provided sets of price sensitivity indicators. These indicators have been chosen from amongst the factors whose variations are likely to have the most effect on the overall lifetime cost estimates. Some of these sensitivity factors relate to the one-time build cost, for example, changes to the costs of materials, whilst others can relate to the variable operating costs, such as circuit loading levels, which affect losses.

However, the sensitivities analysis is limited in its scope, and it would be wrong to blindly apply the cost comparisons to the more extreme or arduous transmission applications, for example in predominantly mountainous regions. In these circumstances, additional costs associated with the particular environment, such as the geology and difficulty of access, would apply to all of the transmission options, but in particular to the underground technologies.

The costs

The following notes indicate the costs we have estimated:

- Firstly, we have estimated the build costs for each transmission technology. The build costs are subdivided into those costs which are fixed regardless of the length of the new connection (fixed build costs), and those costs which are variable in proportion to the route length (variable build costs).
- Secondly, we have estimated the variable operating costs (maintenance and losses) which would arise over the lifetime of the equipment. This has allowed us to calculate the overall lifetime cost as the sum total of the fixed and variable build costs (the build cost) and the variable operating costs.
- Division of the lifetime cost by the length of the transmission connection provides a value for the lifetime cost per km.
- Division of the lifetime cost per km by the connection capacity³ gives a value that we label the lifetime power transfer cost. This latter figure is provided for completeness and comparative purposes for those who have an interest in these values.

The reader should note, however, that the different transmission technologies may not use the same route or be of the same route length. We therefore recommend that, wherever possible, practical route options for each transmission technology for a given application should be identified before comparing transmission costs or making investment decisions.

In addition to materials and installation costs, we have indicated other costs incurred by the transmission asset owner. These latter costs include, for example:

- stakeholder consultation,
- environmental assessment and impact mitigation,
- easements,

³ Capacity measured in MVA for AC technologies or MW for DC technologies.

- consent application, and other planning,
- project management, and
- maintenance.

One cost specifically not included in this study is that of any public inquiry. There are two reasons for this. Firstly, it is not always the case that a public inquiry would take place. Secondly, public inquiries may last less than a week, or span more than a year. Incorporating such uncertainty in our costs would only blur the estimates we have presented here, and reduce their clarity.

As far as possible, the costs were constructed with a bottom-up approach, using supplier and installer data, and comparing these with top-down project cost data supplied by owners. We used both types of data, where these were available, to arrive at an independent view of the cost of providing each technology in England and Wales, and we applied professional judgement to resolve areas where incoming cost information was limited or inconsistent.

Further details on costings may be found in Appendix C, and in each of the transmission technology description appendices.

6 Introduction to the lifetime cost charts

Lifetime cost and sensitivity charts

Due to the large variety of factors involved in the specification of any transmission connection, a number of technical options usually arise, and cost estimating of a particular project can thus become complex. We have striven to simplify this complexity in three ways. Firstly, we have presented our lifetime cost estimates (explained further, below) on separate pages for:

- different transmission route lengths,
- different technologies, and
- different transmission capacities.⁴

This is so that the reader who has in mind a particular application may select the appropriate page(s) before considering the costs in any further detail. These lifetime cost estimates are presented in a series of three pie charts (explained further, below), so that the key costs are easily identified.

Secondly, we have presented a set of “sensitivity factors” for each transmission option, which allow the reader to identify the factors that are most likely to modify the cost estimates. These sensitivities are presented in a horizontal bar chart format, so that the factors to which the cost would be most sensitive may be easily identified. We present each set of lifetime cost estimate pie charts on a double-page spread opposite their associated price sensitivity factor bar chart, so that all the information associated with one technology + route length + capacity option can be seen at a glance. These two-page spreads are to be found in the following section.

The third way we have reduced the complexity of the cost-estimating information is to provide a series of summary cost comparison graphs in bar chart format. These charts allow easy comparison of the costs of the different technologies which may be used on a particular transmission application. They are presented in Section 8 – Summary bar charts and tables.

Chart descriptions

On the left-hand page of each double-page spread we provide three pie charts. These provide cost breakdowns, and each is described next.

⁴ Transmission capacity is a measure of the power or rate of energy flow of which a connection is capable. For normal alternating current connections this capacity is measured in megavolt-amps (MVA) whilst for high voltage direct current connections the capacity is measured in megawatts (MW). For the purposes of this study, 1MVA is equivalent to 1MW.

On the top chart are the fixed build costs – that is to say, those construction costs which are not dependent upon route length. For example, in this case of an underground cable, the

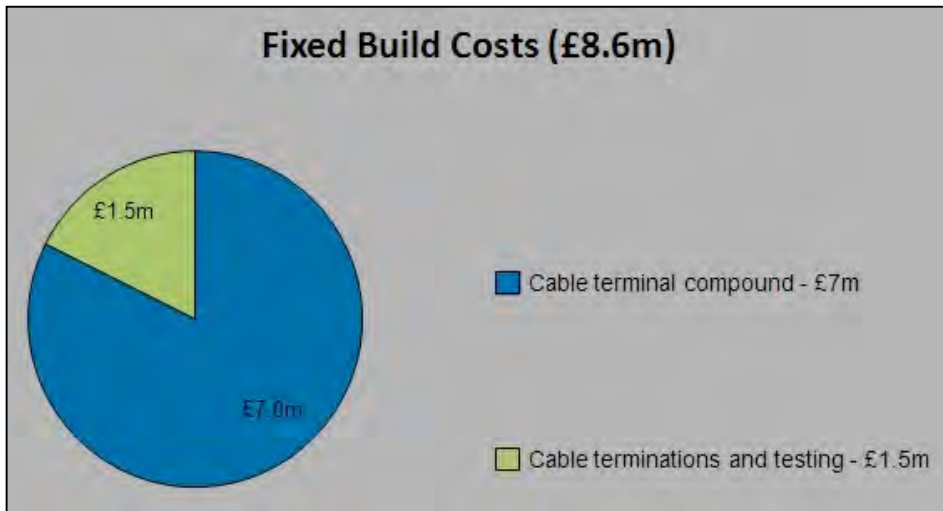

equipment needed at both ends of the cable (the cable terminations and their compounds) need to be paid for, regardless of the length of the underground cable itself. The total cost for this option is provided in the pie chart heading, (£8.6m in this case). The order of the costed items listed in the key to the right of the pie chart is the same as the order of the pie segments, read clockwise, starting at 12 o'clock. A breakdown of the fixed build costs included within each segment of the pie chart can be found in the relevant appendix describing that technology.

On the centre chart are the variable build costs – that is to say, those construction costs that vary with route length. In this case, for example, the on-route cable system materials

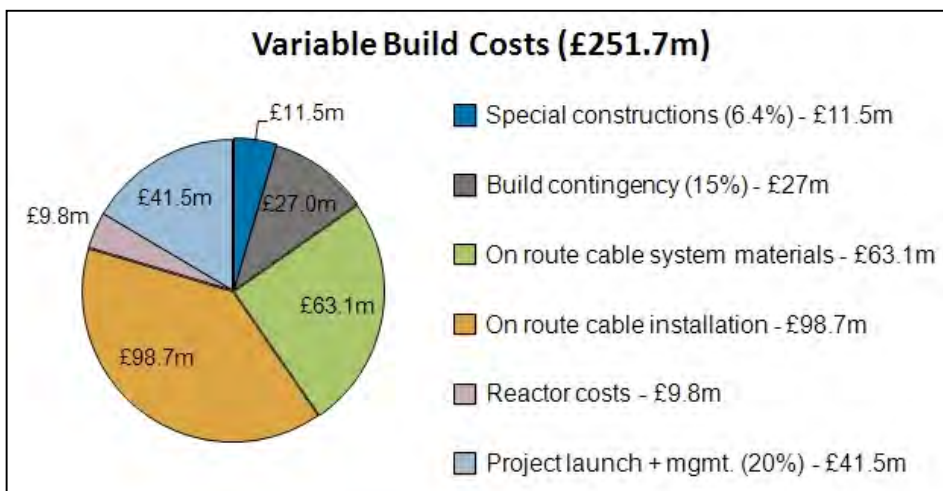

costs are directly proportional to the length of the route. Again, the total variable build cost estimate is provided in the chart title (£251.7m), and the item costs are provided on the chart and in the key. As before, the chart may be read clockwise, starting at 12 o'clock, to match segments with the order of items listed in the key. A breakdown of the variable build costs included in each segment of the pie chart can be found in the relevant appendix describing that technology.

Note: Tunnels are complex to cost on a per km basis since there are so many fixed and variable cost elements. To give two examples: (i) no intermediate shaft is required for 4m diameter tunnels less than 3km long, but by 4km at least one shaft is required for safety exit purposes (regardless of ventilation requirements). Shaft costs thus present themselves as a “lumpy” cost that varies with tunnel length as well as depth. (ii) At some (arbitrary) tunnel length the project engineer may decide to buy a second tunnel-boring machine in order to complete the project within a reasonable timescale. We have assumed that this would be the case for a 15km tunnel, but again, this represents a very “lumpy” fixed or variable cost.

On the bottom chart are the operating costs – that is to say, the present value of the costs of operation over the nominal 40-year life of most transmission equipment. Variable

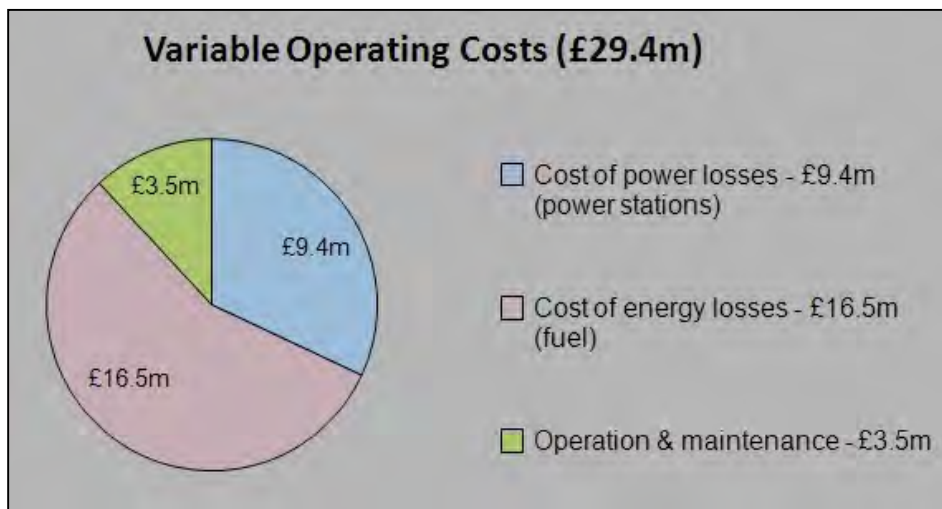

operating costs comprise operations and maintenance, and both power and energy losses.⁵ These costs also vary with route length. The same approach for cost labelling applies to this chart as for the first two. A breakdown of the Variable operating costs included in each segment of the pie chart can be found in the relevant appendix describing that technology.

Please note that, due to rounding errors, the values in the keys of some of the pie charts may not sum to the values stated in the pie chart title.

On the right-hand side of each double-page spread, we provide two items. In the upper portion is a sensitivity bar chart. This chart indicates the sensitivity of the estimated lifetime cost of the transmission option to a number of key elements that affect the cost build-up. The elements listed in the charts vary between transmission options, depending upon which elements have been identified as having the larger impact on the lifetime cost estimates.

Where possible, and to provide a reasonable basis for comparison, factors have been varied by $\pm 50\%$, and the percentage effect on lifetime costing calculated. Each of the chosen cost-sensitivity elements is listed down the left-hand side of the chart, and beneath the element description is presented a series of three values: the $\pm 50\%$ values and the central value. For example, whilst the central value for “Average circuit loading” is shown in the example chart below to be 34%, the chart shows that a $\pm 50\%$ variation about this average (that is, down to 17% loading, or up to 51% loading) has the effect of varying the overall lifetime cost estimate by -27.5% and $+45.9\%$ respectively.

⁵ Energy losses are the unwanted heating effect of the flow of electricity through the conductors, and these affect the amount of generator fuel that is burnt. Power losses are the costs of building the extra generation equipment needed to supply the energy losses. See Appendix D for further information.

When reading these charts, note that the central value of the overall lifetime cost estimate is always represented by the central, vertical, 0% line on the chart. The effect of the first value (or lower variation) in the series of three values is always represented by the yellow bar, whilst the effect of the third (or upper variation) in the series of three is represented by the blue bar.

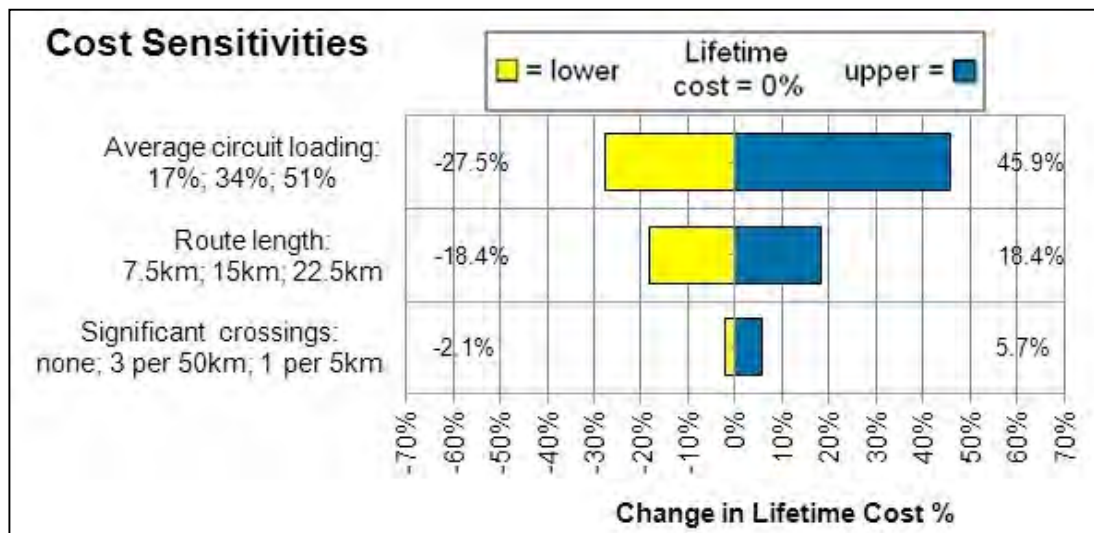

To take another example – this time not a numerical one – the central assumption for the number of “significant crossings” (in this example chart) is that there would be three significant overhead line crossings in a 50km route length. A reduction to no crossings, and an increase to one every 5km, has the effect of changing the overall lifetime cost by -2.1% and +5.7% respectively.

Occasionally, the stated sensitivity deviations can both affect the overall lifetime cost in the same direction. For example, in the cases where underground cable is installed in a tunnel (see, for example, page 69 of this report), the ground conditions known as “mixed wet” are shown as the central option – that is, the option upon which the main tunnel costings were based. However, both the yellow and the blue bars lie to the left of the 0% line in this case, indicating that “competent clay” and “hard rock” are both anticipated to be less costly to tunnel than mixed wet rock.

In the lower portion of the right hand page we present a summary box containing some key results for the transmission option in question. The results include:

- the lifetime cost for the option – that is, the total of the fixed and variable build costs and the variable operating costs shown in the three pie charts (£m),
- the lifetime cost per km (£m/km),
- the lifetime power transfer cost per km (£m/MVA-km or £m/MW-km),
- the percentage of the lifetime costs attributable to losses (%), and
- the two most significant factors affecting the lifetime cost.

To further aid quick identification of the technology combination featured on each of these double-page spreads, the top right of each right-hand page contains one of the following icons, which we hope the reader will find self-explanatory:

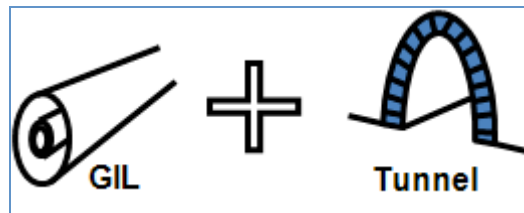
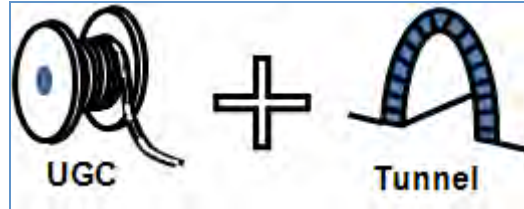
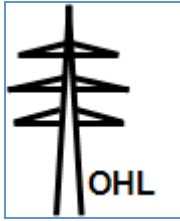

We have also included tabs at the edge of each right-hand page (an example is shown here) to make it easy for the reader to find the desired group of cost charts quickly.

Identical tabs in the appendices link the cost charts for a particular technology with the appendix for that same technology.



7 Lifetime cost charts

Cost charts for overhead line

The following charts present the lifetime cost make-up and associated sensitivities on lifetime cost for overhead line electricity transmission options.

Figure 2 – L6 D60 tower with 400kV insulators and twin conductor bundle



(Photo courtesy of Parsons Brinckerhoff)

AC Overhead Line

3km Route Lifetime Cost: £7.2m

Lo capacity (3190 MVA); 400 kV AC

Fixed Build Costs (£0.5m)

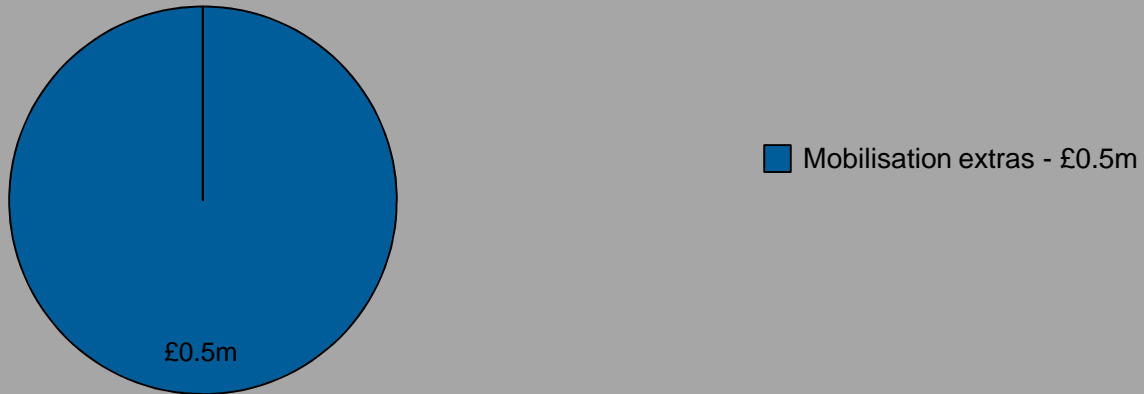

Variable Build Costs (£4.0m)

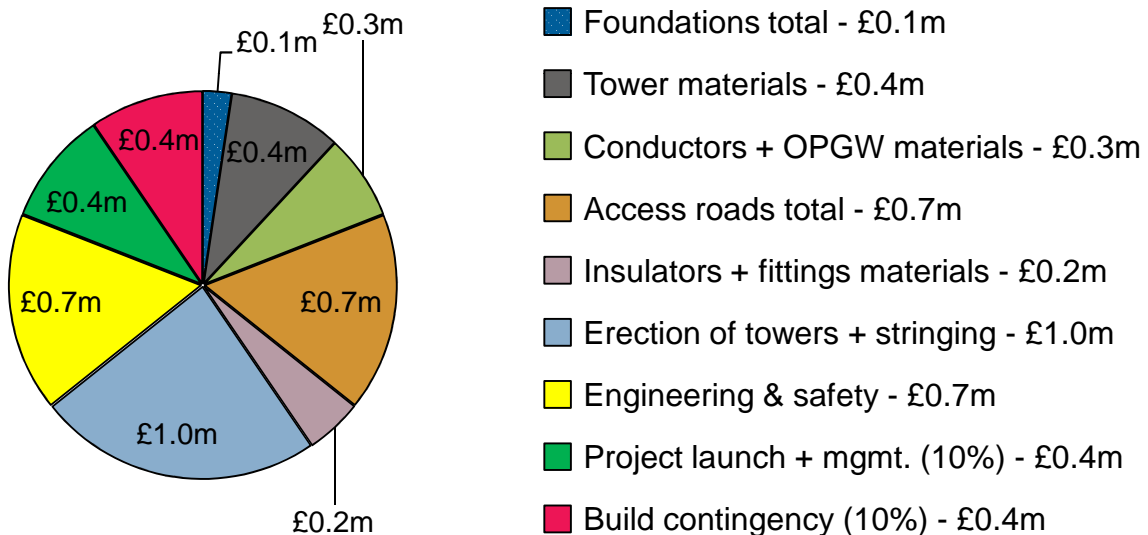

Variable Operating Costs (£2.7m)

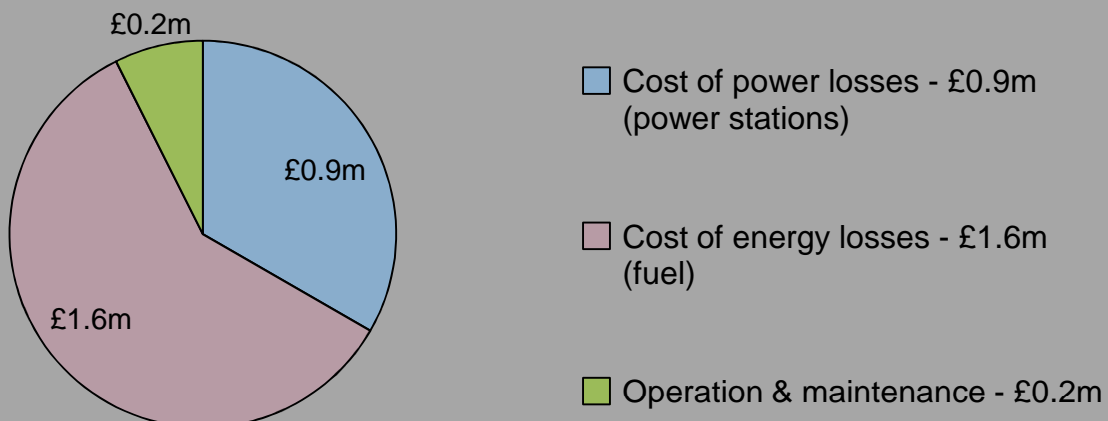

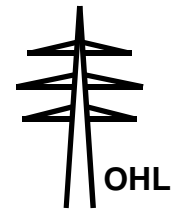

Cost Sensitivities

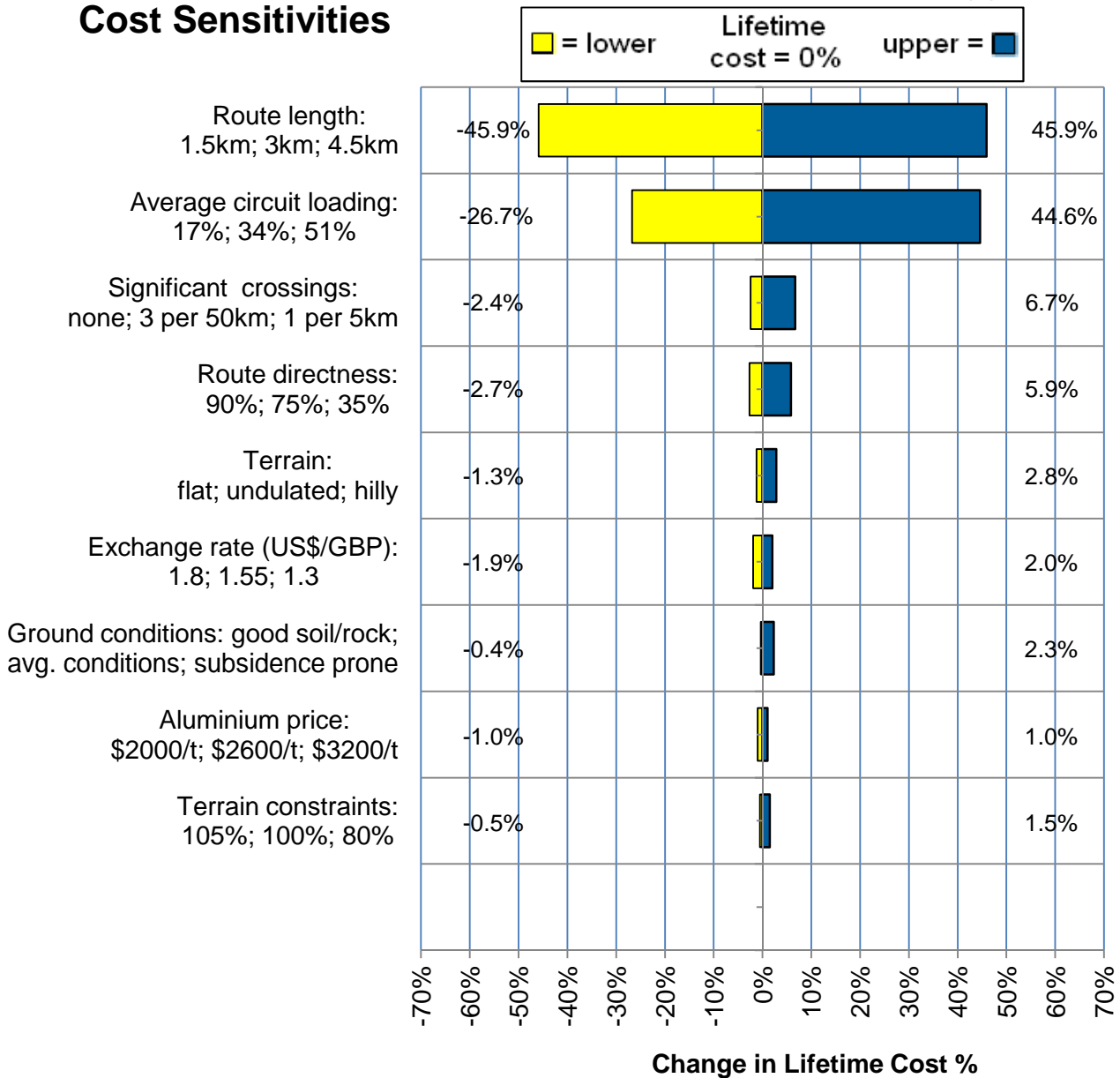

Lifetime Cost Results (£2.4m/km; £750/MVA-km)

| | |
|---|--|
| <p>Fixed Build Cost £0.5m</p> <p>Variable Build Cost £4.0m</p> <p>Build Cost Total for 3km £4.5m</p> <p>plus Variable Operating Cost £2.7m</p> <p>Lifetime Cost for 3km £7.2m</p> | <p>Other Results</p> <p>Losses = 35% of Lifetime Cost for 3km</p> <p>Costs most sensitive to:</p> <ul style="list-style-type: none"> Route length: -45.9% to 45.9% Average circuit loading: -26.7% to 44.6% |
| <p>Lifetime Cost for 3km £7.2m</p> <p>divided by route length ÷ 3km</p> <p>Lifetime Cost per km £2.4m/km</p> | <p>Notes (Jan-12)</p> <p>* PTC = Power Transfer Cost</p> |
| <p>Lifetime Cost per km £2.4m/km</p> <p>divided by Power Transfer ÷ 3190 MVA</p> <p>Lifetime PTC* per km £750/MVA-km</p> | |

AC Overhead Line

3km Route Lifetime Cost: £12.6m

Med capacity (6380 MVA); 400 kV AC

Fixed Build Costs (£0.6m)

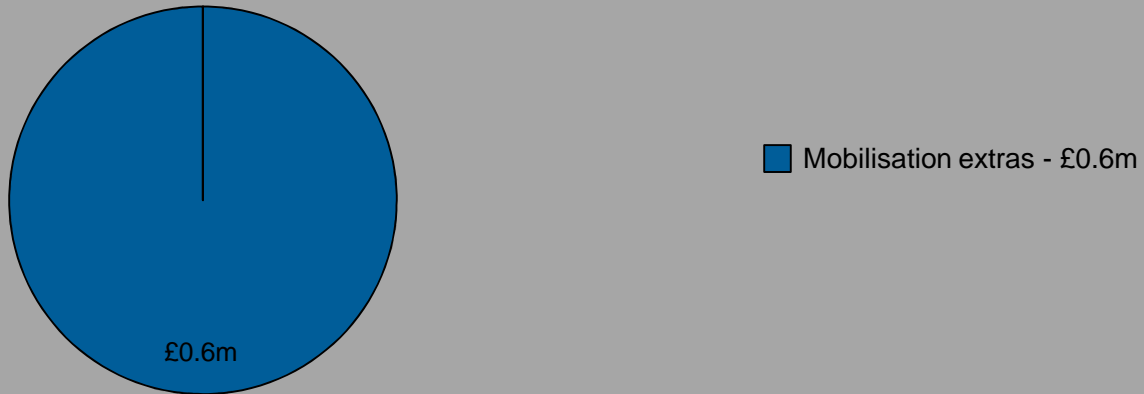

Variable Build Costs (£4.7m)

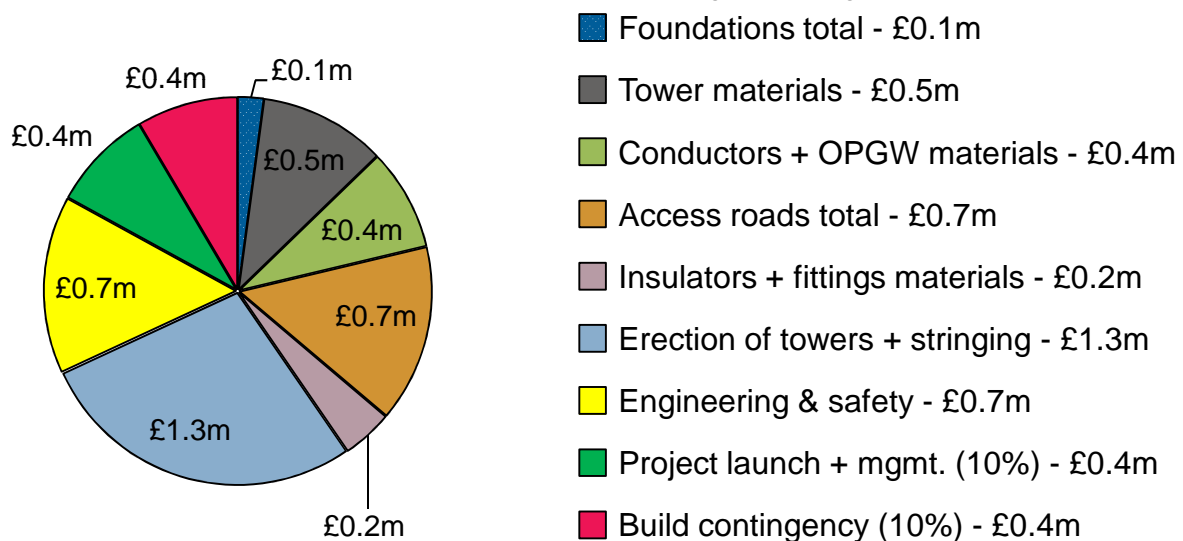

Variable Operating Costs (£7.3m)

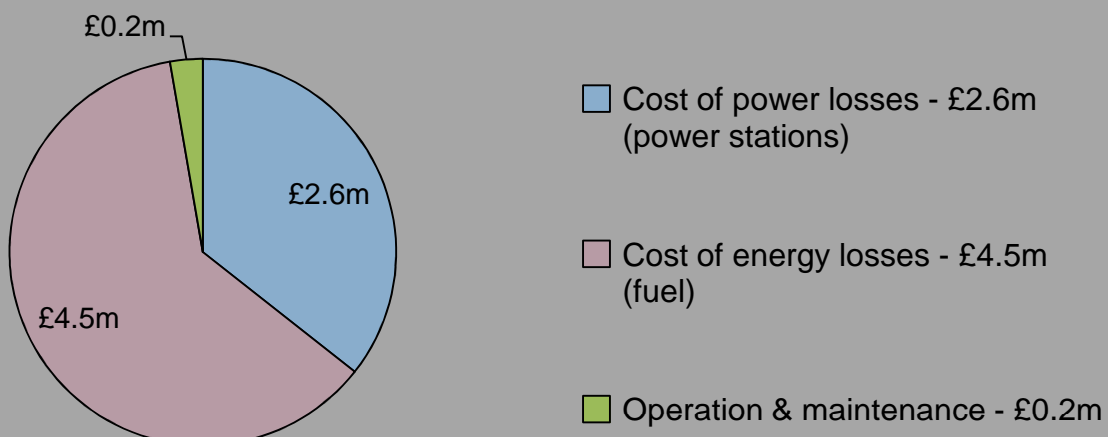

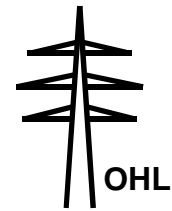

Cost Sensitivities

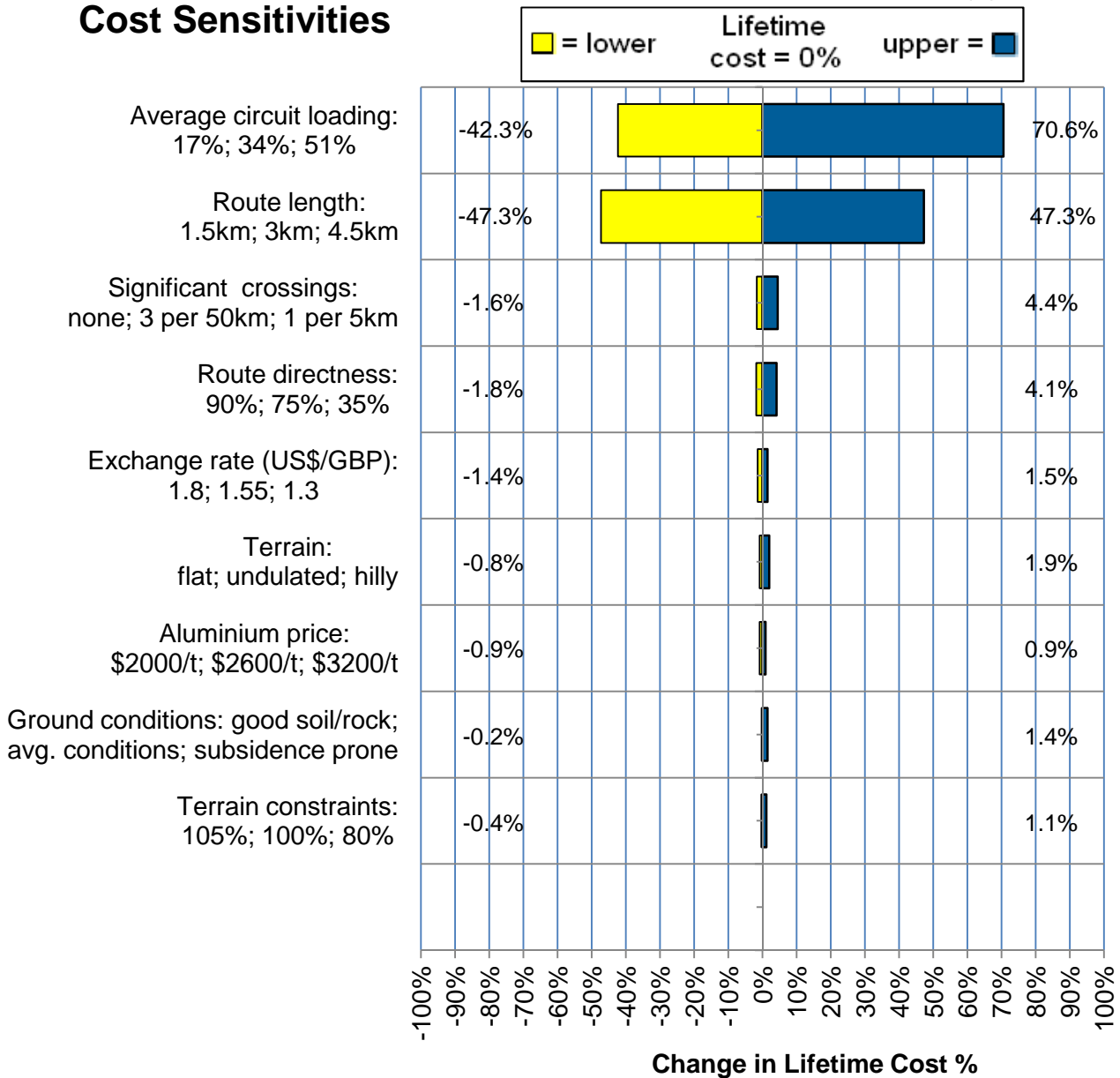

Lifetime Cost Results (£4.2m/km; £660/MVA-km)

| | | |
|---|------------------------|--|
| Fixed Build Cost | £0.6m | Other Results Losses = 56% of Lifetime Cost for 3km Costs most sensitive to: • Average circuit loading: -42.3% to 70.6% • Route length: -47.3% to 47.3% |
| Variable Build Cost | £4.7m | |
| Build Cost Total for 3km | £5.3m | |
| plus Variable Operating Cost | £7.3m | |
| Lifetime Cost for 3km | £12.6m | Notes (Jan-12) * PTC = Power Transfer Cost |
| Lifetime Cost for 3km divided by route length ÷ 3km | £12.6m ÷ 3km | |
| Lifetime Cost per km | £4.2m/km | |
| Lifetime Cost per km divided by Power Transfer ÷ 6380 MVA | £4.2m/km ÷ 6380 MVA | |
| Lifetime PTC* per km | £660/MVA-km | |

AC Overhead Line

3km Route Lifetime Cost: £12.7m

Hi capacity (6930 MVA); 400 kV AC

Fixed Build Costs (£0.6m)

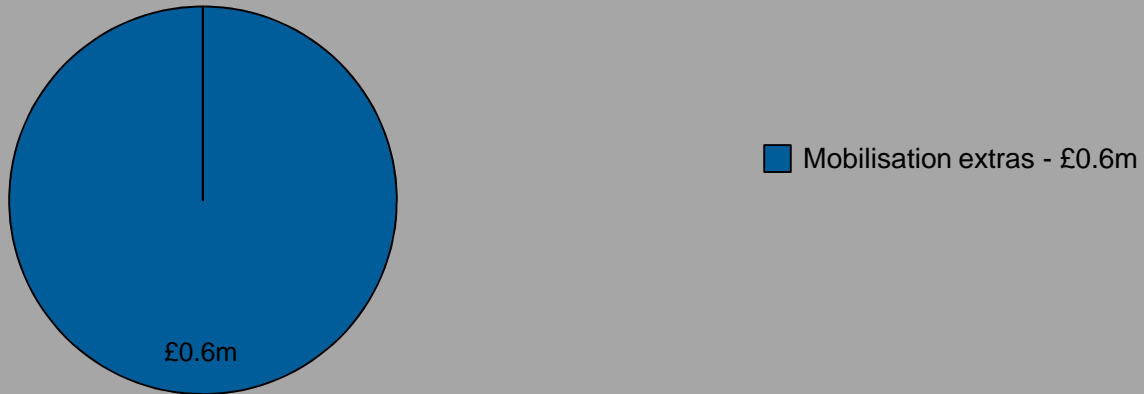

Variable Build Costs (£5.4m)

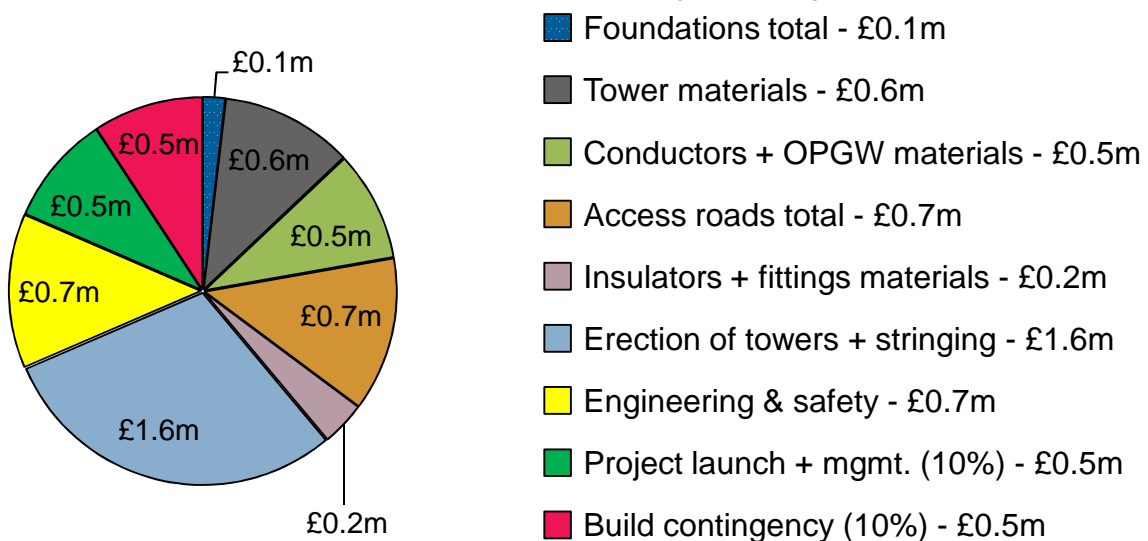

Variable Operating Costs (£6.6m)

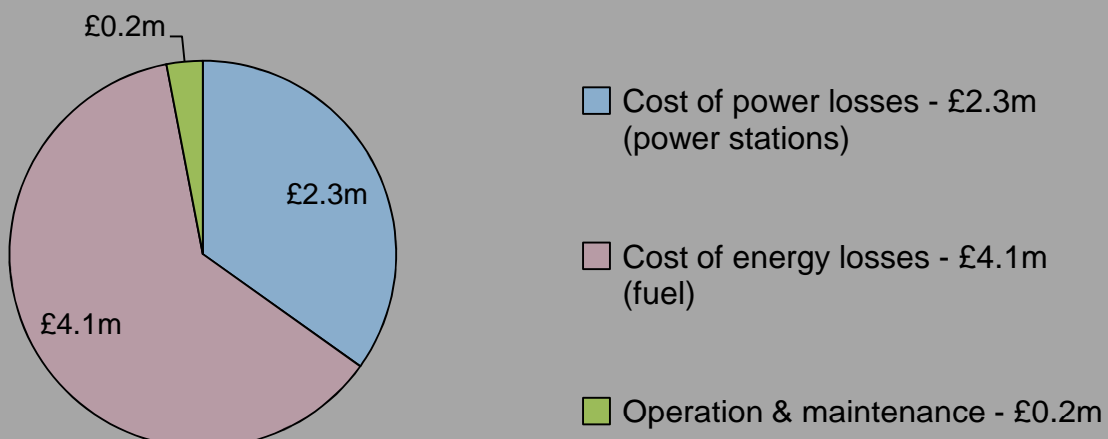

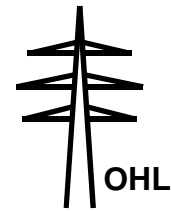

Cost Sensitivities

= lower
 Lifetime cost = 0%
 upper =

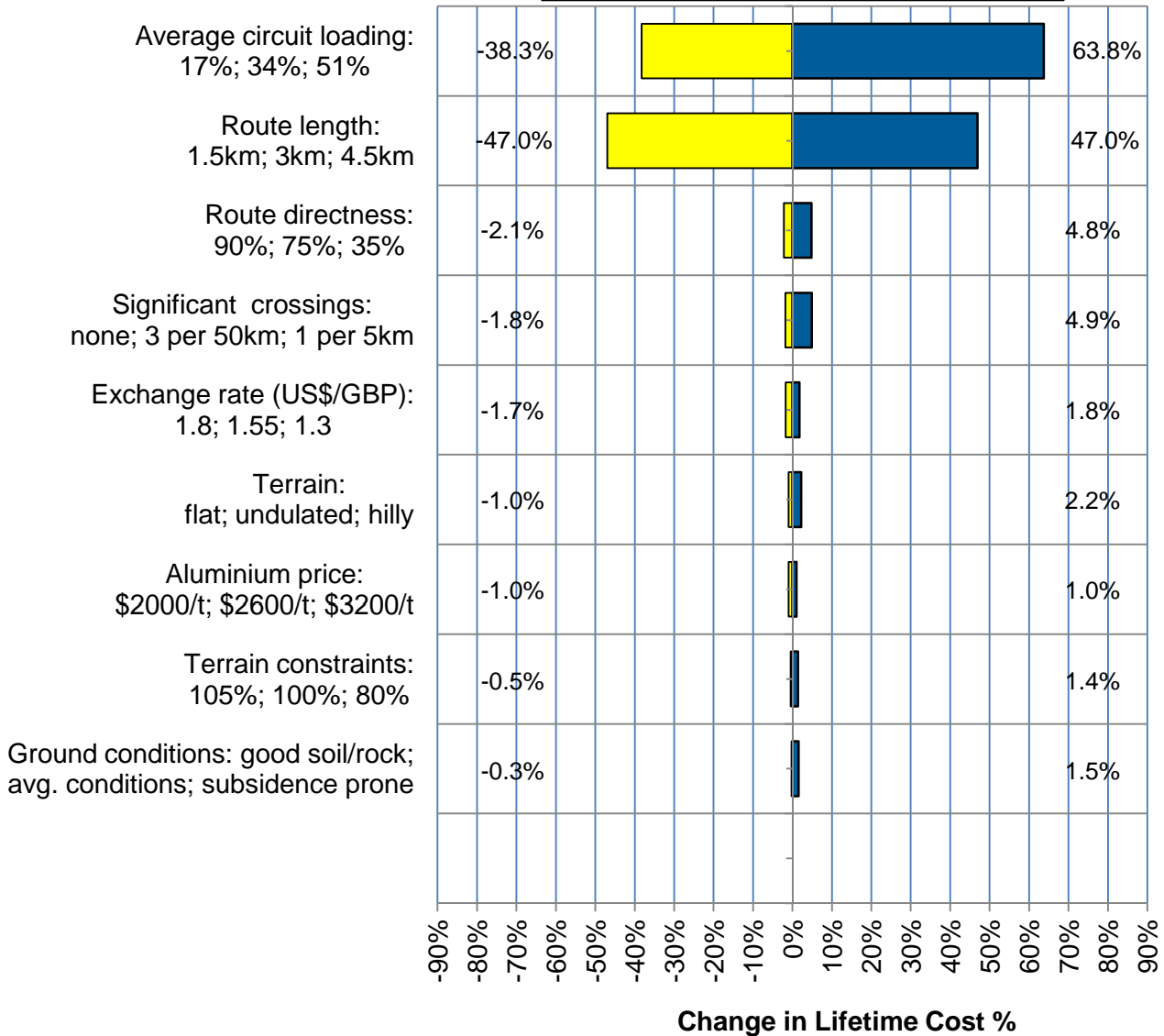

Lifetime Cost Results (£4.2m/km; £610/MVA-km)

| | | |
|---|------------------------|---|
| Fixed Build Cost | £0.6m | Other Results Losses = 50% of Lifetime Cost for 3km Costs most sensitive to: <ul style="list-style-type: none"> Average circuit loading: -38.3% to 63.8% Route length: -47% to 47% |
| Variable Build Cost | £5.4m | |
| Build Cost Total for 3km | £6.0m | |
| plus Variable Operating Cost | £6.6m | |
| Lifetime Cost for 3km | £12.7m | Notes (Jan-12) * PTC = Power Transfer Cost |
| Lifetime Cost for 3km divided by route length ÷ 3km | £12.7m ÷ 3km | |
| Lifetime Cost per km | £4.2m/km | |
| Lifetime Cost per km divided by Power Transfer ÷ 6930 MVA | £4.2m/km ÷ 6930 MVA | |
| Lifetime PTC* per km | £610/MVA-km | |

AC Overhead Line

15km Route Lifetime Cost: £35.1m

Lo capacity (3190 MVA); 400 kV AC

Fixed Build Costs (£1.6m)

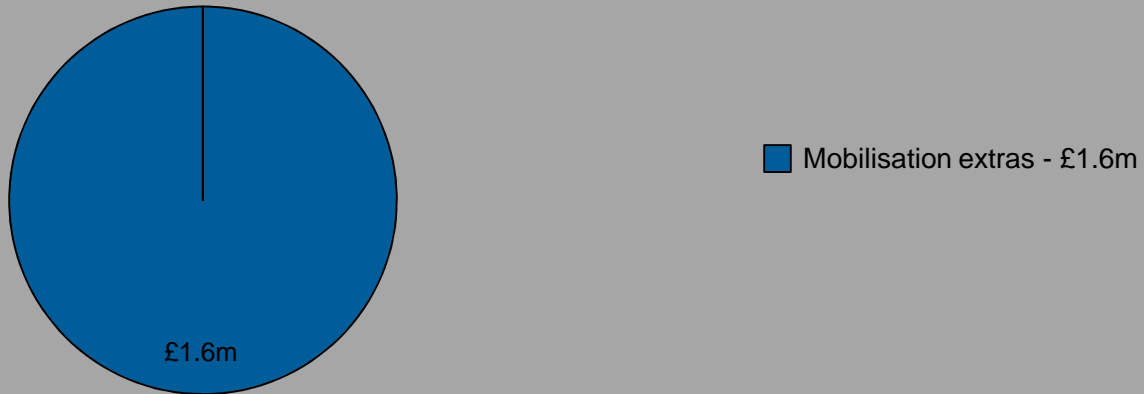

Variable Build Costs (£19.8m)

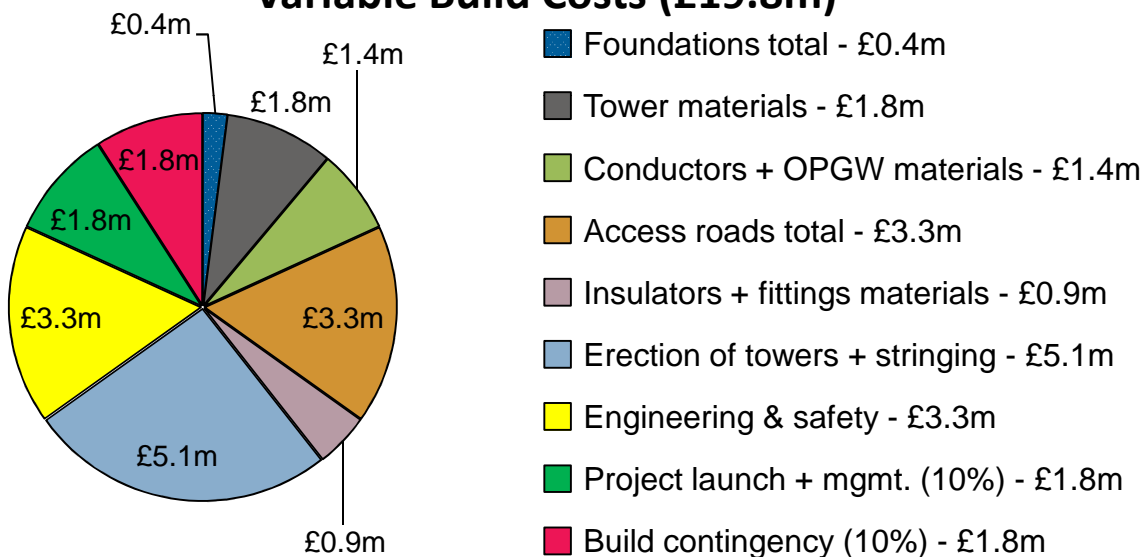

Variable Operating Costs (£13.7m)

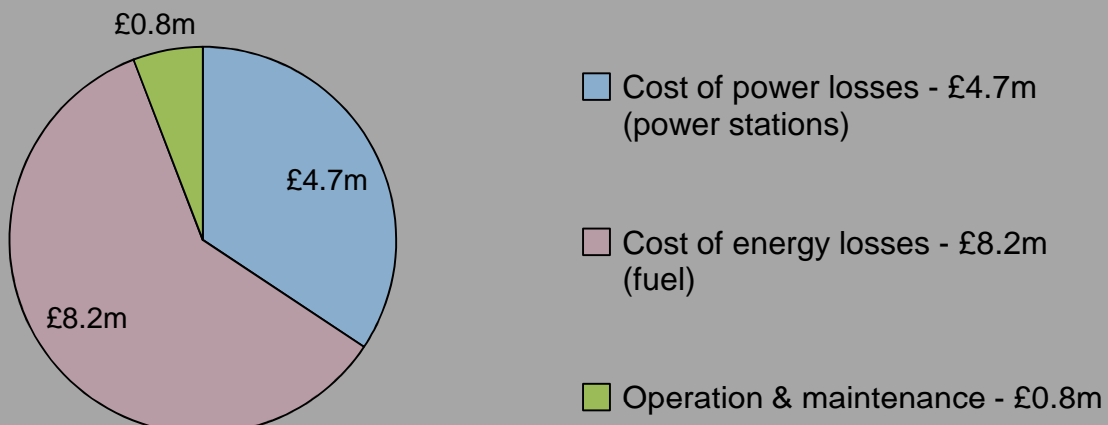

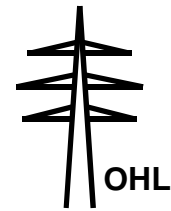

Cost Sensitivities

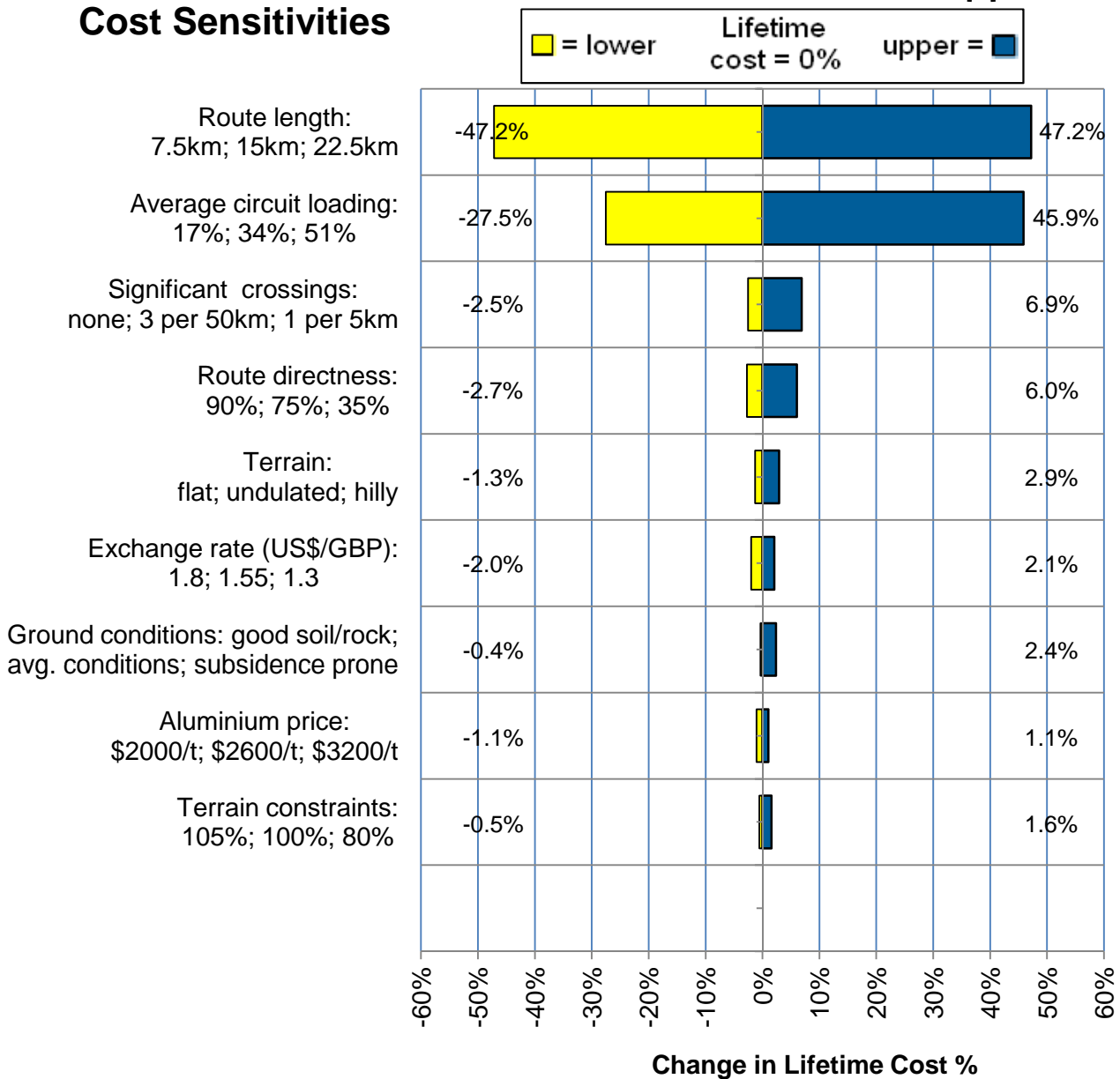

Lifetime Cost Results (£2.3m/km; £730/MVA-km)

| | |
|--|---------------------|
| Fixed Build Cost | £1.6m |
| Variable Build Cost | £19.8m |
| Build Cost Total for 15km | £21.4m |
| plus Variable Operating Cost | £13.7m |
| Lifetime Cost for 15km | £35.1m |
| ↓ | |
| Lifetime Cost for 15km divided by route length | £35.1m ÷ 15km |
| Lifetime Cost per km | £2.3m/km |
| ↓ | |
| Lifetime Cost per km divided by Power Transfer | £2.3m/km ÷ 3190 MVA |
| Lifetime PTC* per km | £730/MVA-km |

| |
|--|
| Other Results |
| Losses = 37% of Lifetime Cost for 15km |
| Costs most sensitive to: |
| • Route length: -47.2% to 47.2% |
| • Average circuit loading: -27.5% to 45.9% |

| |
|-----------------------------|
| Notes (Jan-12) |
| * PTC = Power Transfer Cost |

AC Overhead Line

15km Route Lifetime Cost: £61.6m

Med capacity (6380 MVA); 400 kV AC

Fixed Build Costs (£1.9m)

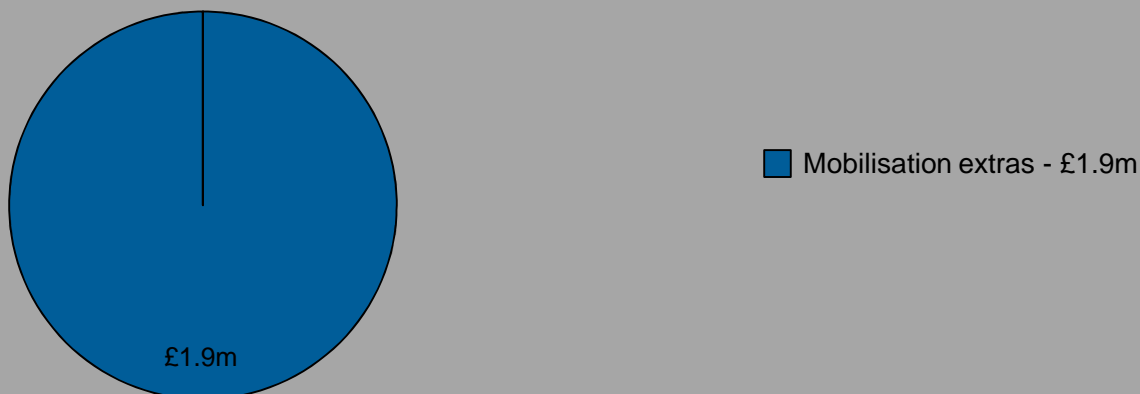

Variable Build Costs (£23.3m)

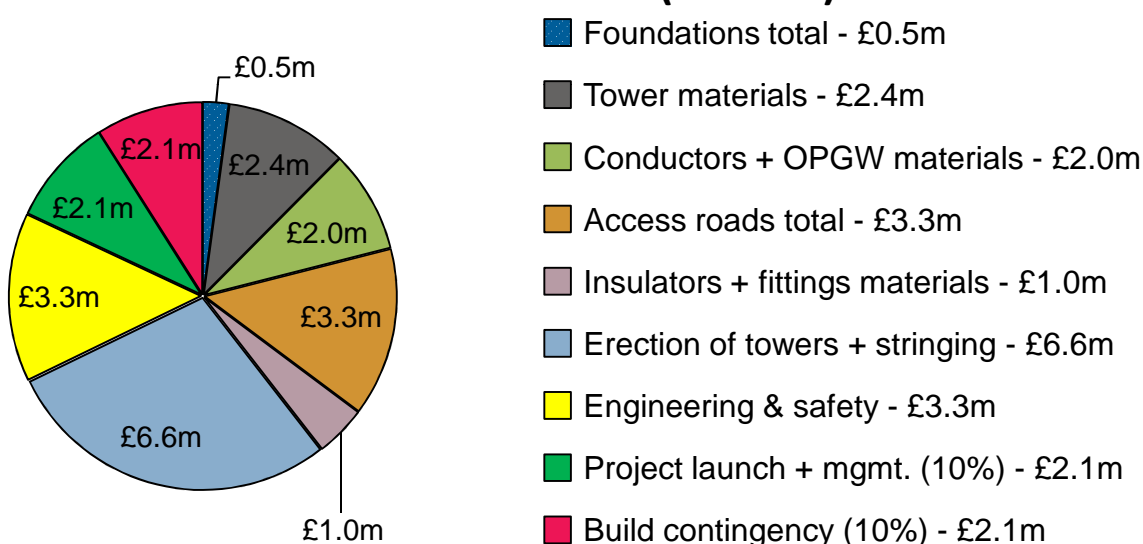

Variable Operating Costs (£36.4m)

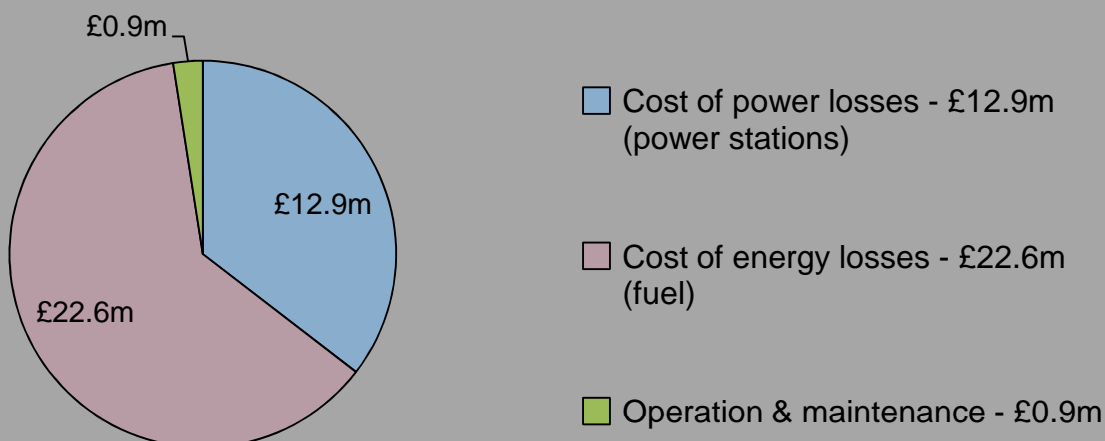

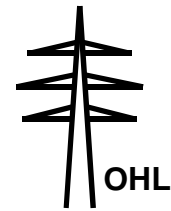

Cost Sensitivities

= lower
 Lifetime cost = 0%
 upper =

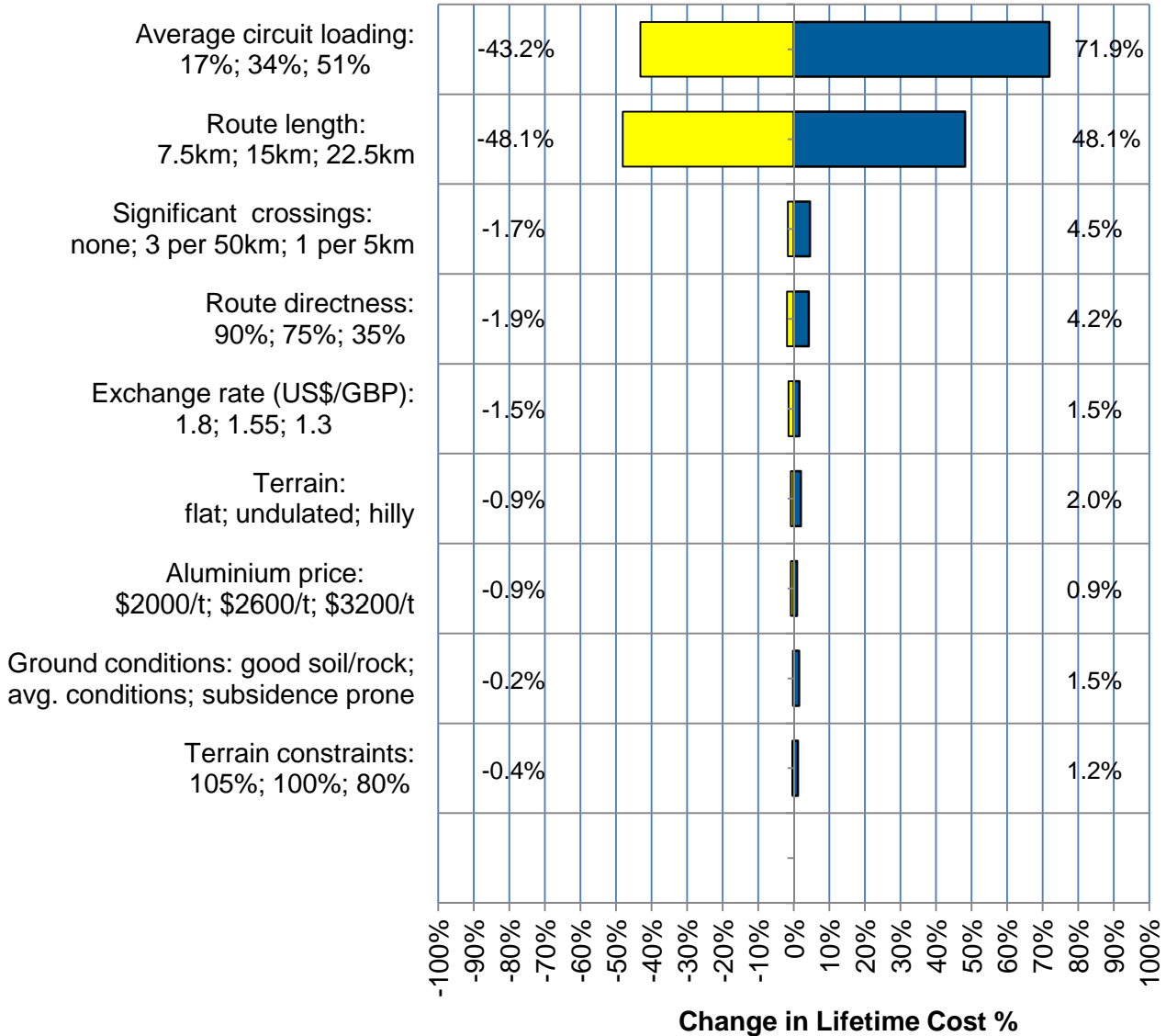

Lifetime Cost Results (£4.1m/km; £640/MVA-km)

| | |
|---|------------------------|
| Fixed Build Cost | £1.9m |
| Variable Build Cost | £23.3m |
| Build Cost Total for 15km | £25.2m |
| plus Variable Operating Cost | £36.4m |
| Lifetime Cost for 15km | £61.6m |
| ↓ | |
| Lifetime Cost for 15km divided by route length | £61.6m ÷ 15km |
| Lifetime Cost per km | £4.1m/km |
| ↓ | |
| Lifetime Cost per km divided by Power Transfer | £4.1m/km ÷ 6380 MVA |
| Lifetime PTC* per km | £640/MVA-km |

Other Results
 Losses = 58% of Lifetime Cost for 15km

Costs most sensitive to:

- Average circuit loading:
-43.2% to 71.9%
- Route length:
-48.1% to 48.1%

Notes (Jan-12)

* PTC = Power Transfer Cost

AC Overhead Line

15km Route Lifetime Cost: £62.2m

Hi capacity (6930 MVA); 400 kV AC

Fixed Build Costs (£2.2m)

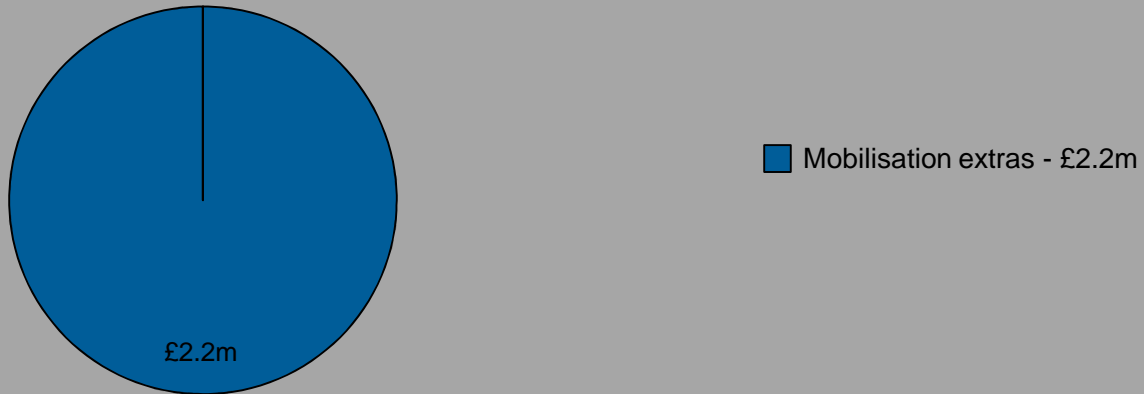

Variable Build Costs (£26.6m)

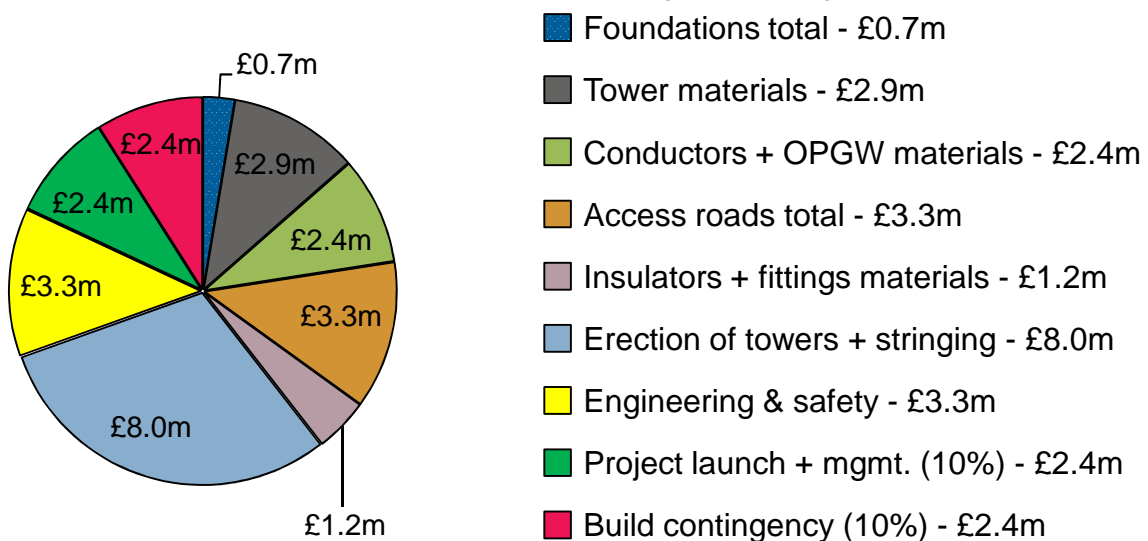

Variable Operating Costs (£33.4m)

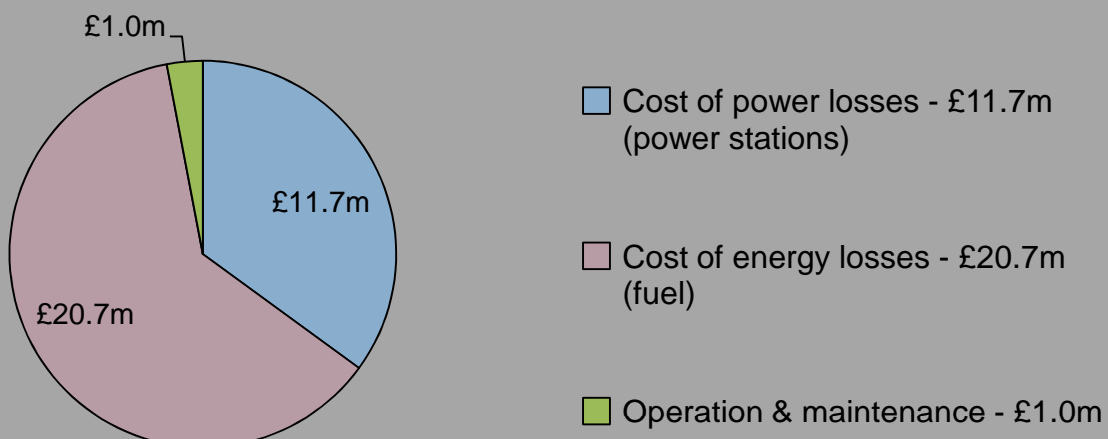

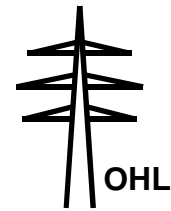

Cost Sensitivities

= lower
 Lifetime cost = 0%
 upper =

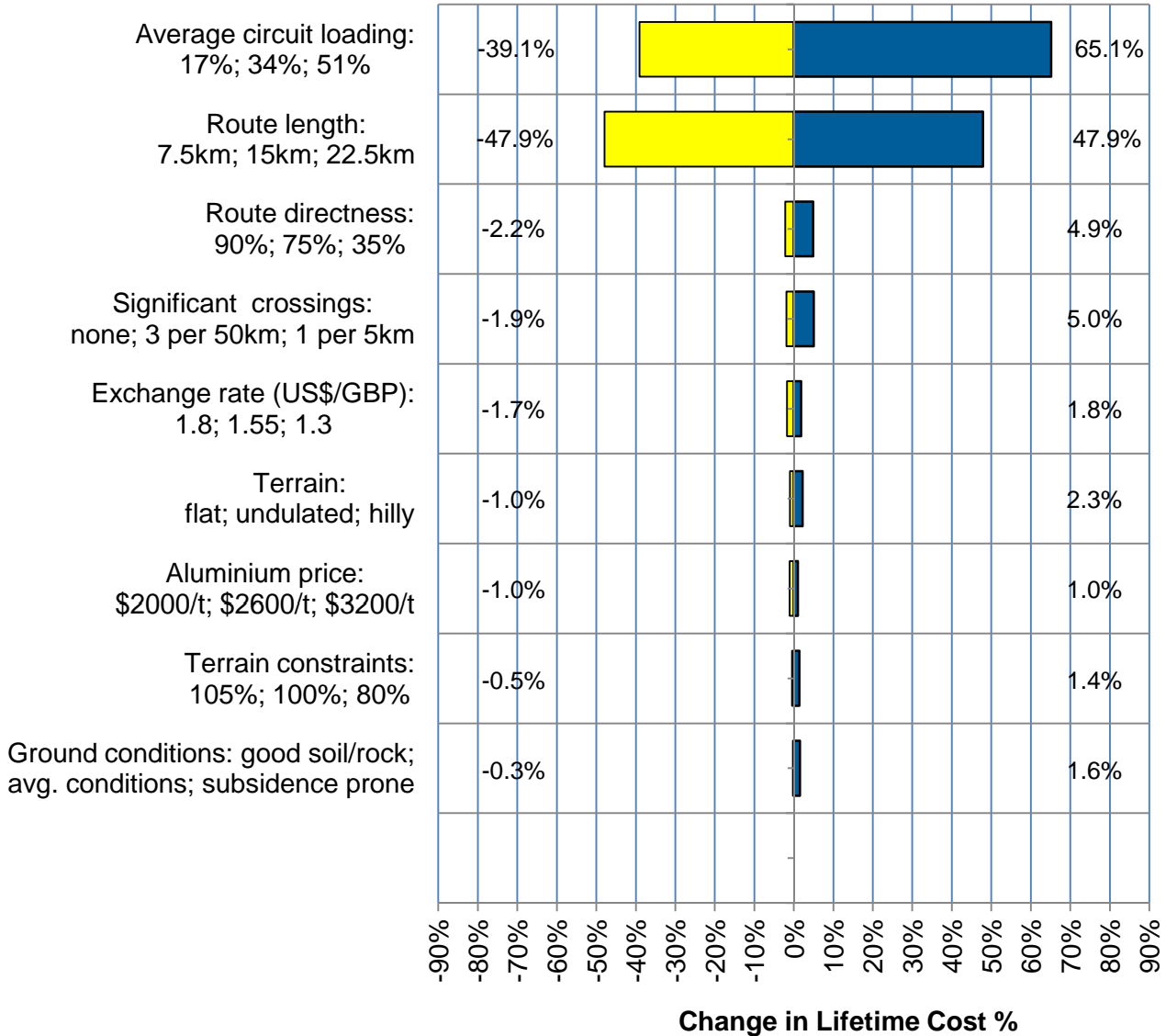

Lifetime Cost Results (£4.1m/km; £600/MVA-km)

| | |
|---|------------------------|
| Fixed Build Cost | £2.2m |
| Variable Build Cost | £26.6m |
| Build Cost Total for 15km | £28.8m |
| plus Variable Operating Cost | £33.4m |
| Lifetime Cost for 15km | £62.2m |
| ↓ | |
| Lifetime Cost for 15km divided by route length | £62.2m ÷ 15km |
| Lifetime Cost per km | £4.1m/km |
| ↓ | |
| Lifetime Cost per km divided by Power Transfer | £4.1m/km ÷ 6930 MVA |
| Lifetime PTC* per km | £600/MVA-km |

| |
|---|
| Other Results |
| Losses = 52% of Lifetime Cost for 15km |
| Costs most sensitive to: |
| <ul style="list-style-type: none"> Average circuit loading: -39.1% to 65.1% Route length: -47.9% to 47.9% |

| |
|-----------------------------|
| Notes (Jan-12) |
| * PTC = Power Transfer Cost |

AC Overhead Line

75km Route Lifetime Cost: £168.2m

Lo capacity (3190 MVA); 400 kV AC

Fixed Build Costs (£2.5m)

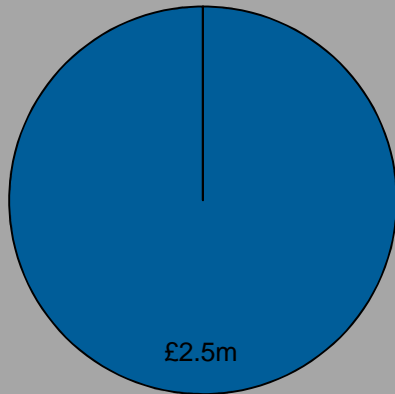

■ Mobilisation extras - £2.5m

Variable Build Costs (£97.7m)

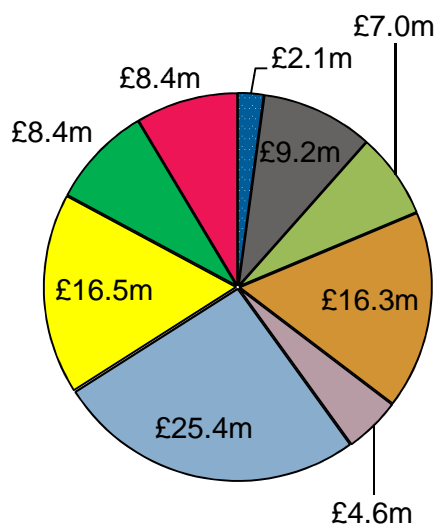

- Foundations total - £2.1m
- Tower materials - £9.2m
- Conductors + OPGW materials - £7.0m
- Access roads total - £16.3m
- Insulators + fittings materials - £4.6m
- Erection of towers + stringing - £25.4m
- Engineering & safety - £16.5m
- Project launch + mgmt. (10%) - £8.4m
- Build contingency (10%) - £8.4m

Variable Operating Costs (£68.0m)

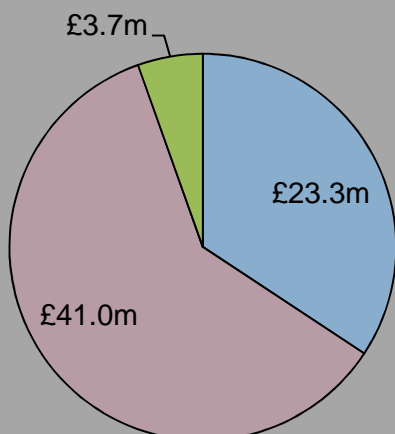

- Cost of power losses - £23.3m (power stations)
- Cost of energy losses - £41.0m (fuel)
- Operation & maintenance - £3.7m

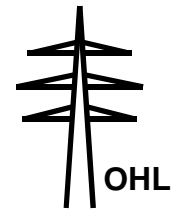

Cost Sensitivities

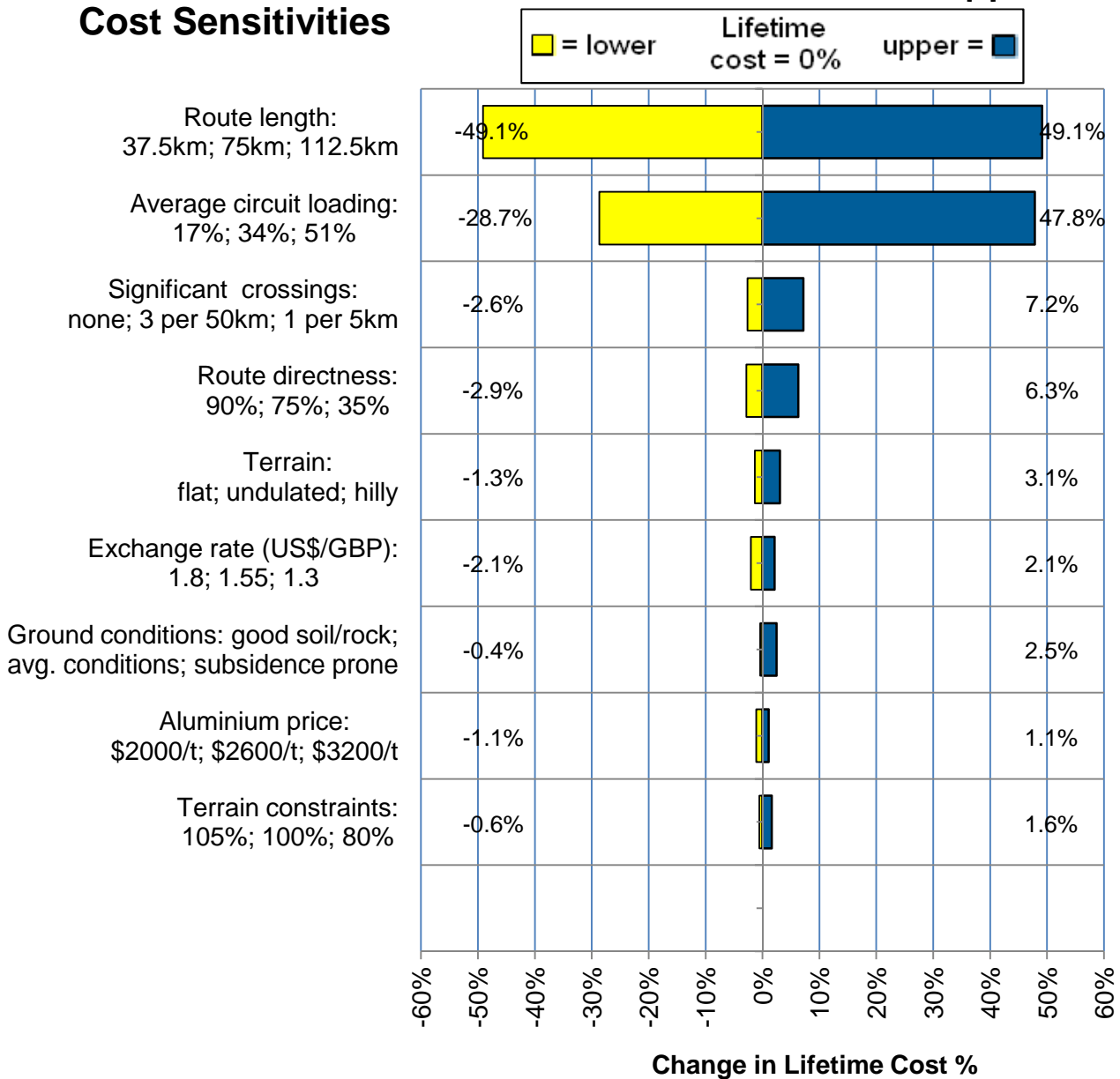

Lifetime Cost Results (£2.2m/km; £700/MVA-km)

| | |
|--|---------------------|
| Fixed Build Cost | £2.5m |
| Variable Build Cost | £97.7m |
| Build Cost Total for 75km | £100.2m |
| plus Variable Operating Cost | £68.0m |
| Lifetime Cost for 75km | £168.2m |
| ↓ | |
| Lifetime Cost for 75km divided by route length | £168.2m ÷ 75km |
| Lifetime Cost per km | £2.2m/km |
| ↓ | |
| Lifetime Cost per km divided by Power Transfer | £2.2m/km ÷ 3190 MVA |
| Lifetime PTC* per km | £700/MVA-km |

| |
|--|
| Other Results |
| Losses = 38% of Lifetime Cost for 75km |
| Costs most sensitive to: |
| • Route length: -49.1% to 49.1% |
| • Average circuit loading: -28.7% to 47.8% |

| |
|-----------------------------|
| Notes (Jan-12) |
| * PTC = Power Transfer Cost |

AC Overhead Line

75km Route Lifetime Cost: £299.8m

Med capacity (6380 MVA); 400 kV AC

Fixed Build Costs (£2.9m)

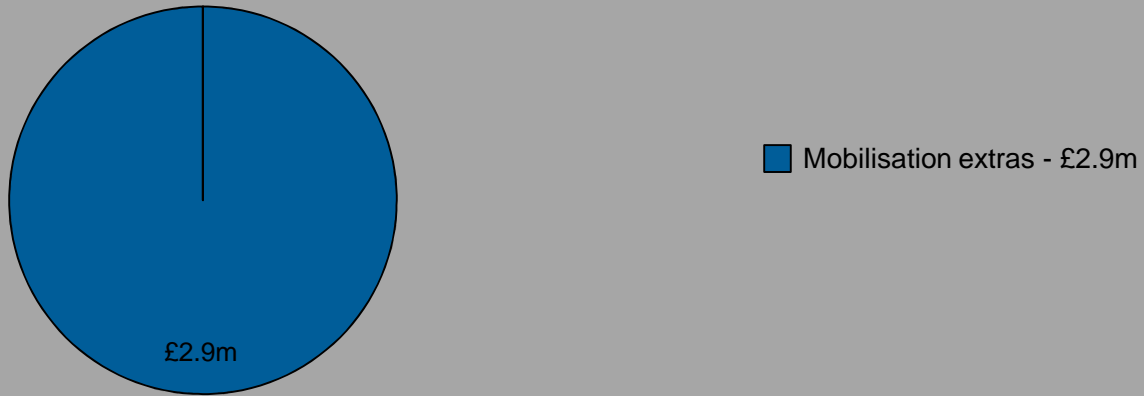

Variable Build Costs (£115.3m)

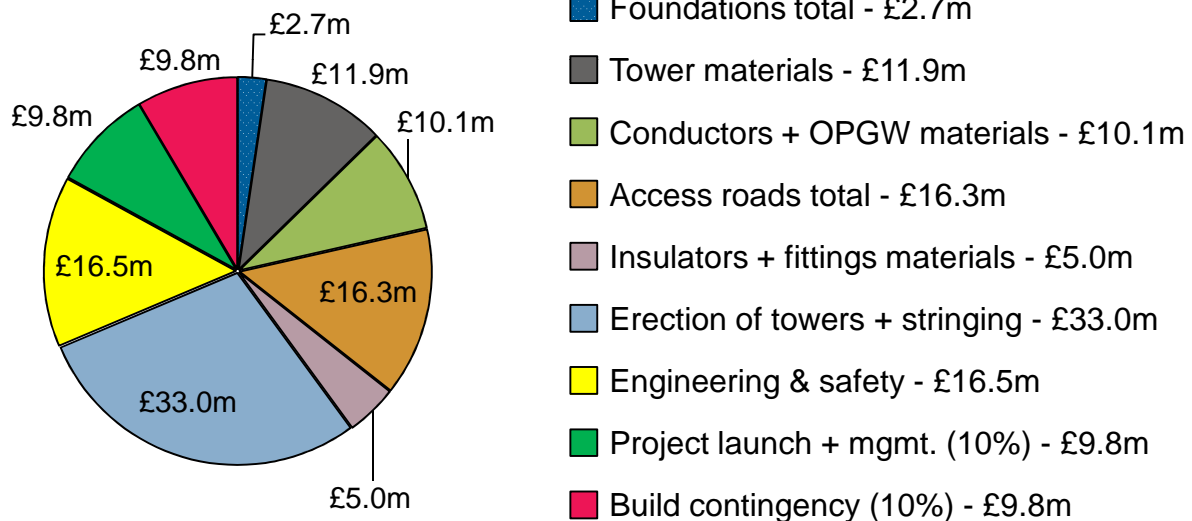

Variable Operating Costs (£181.6m)

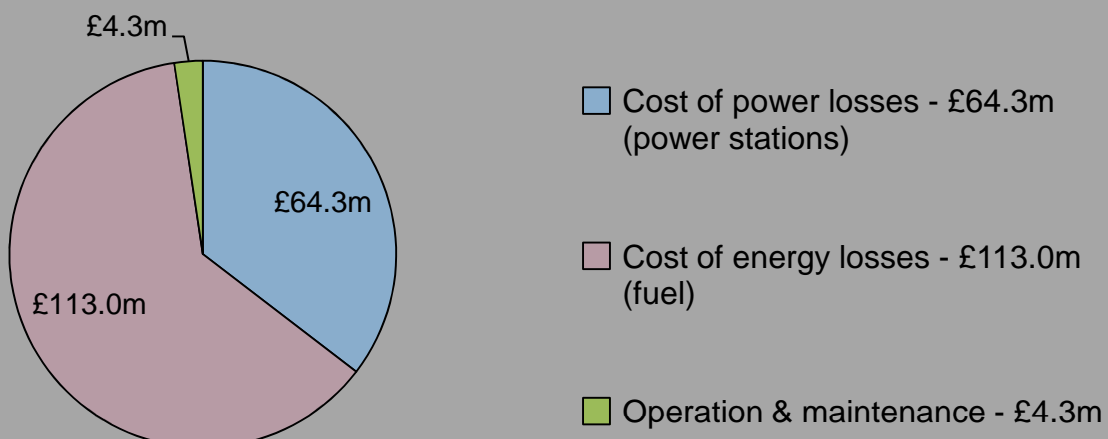

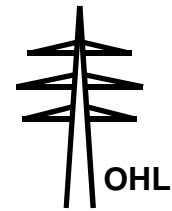

Cost Sensitivities

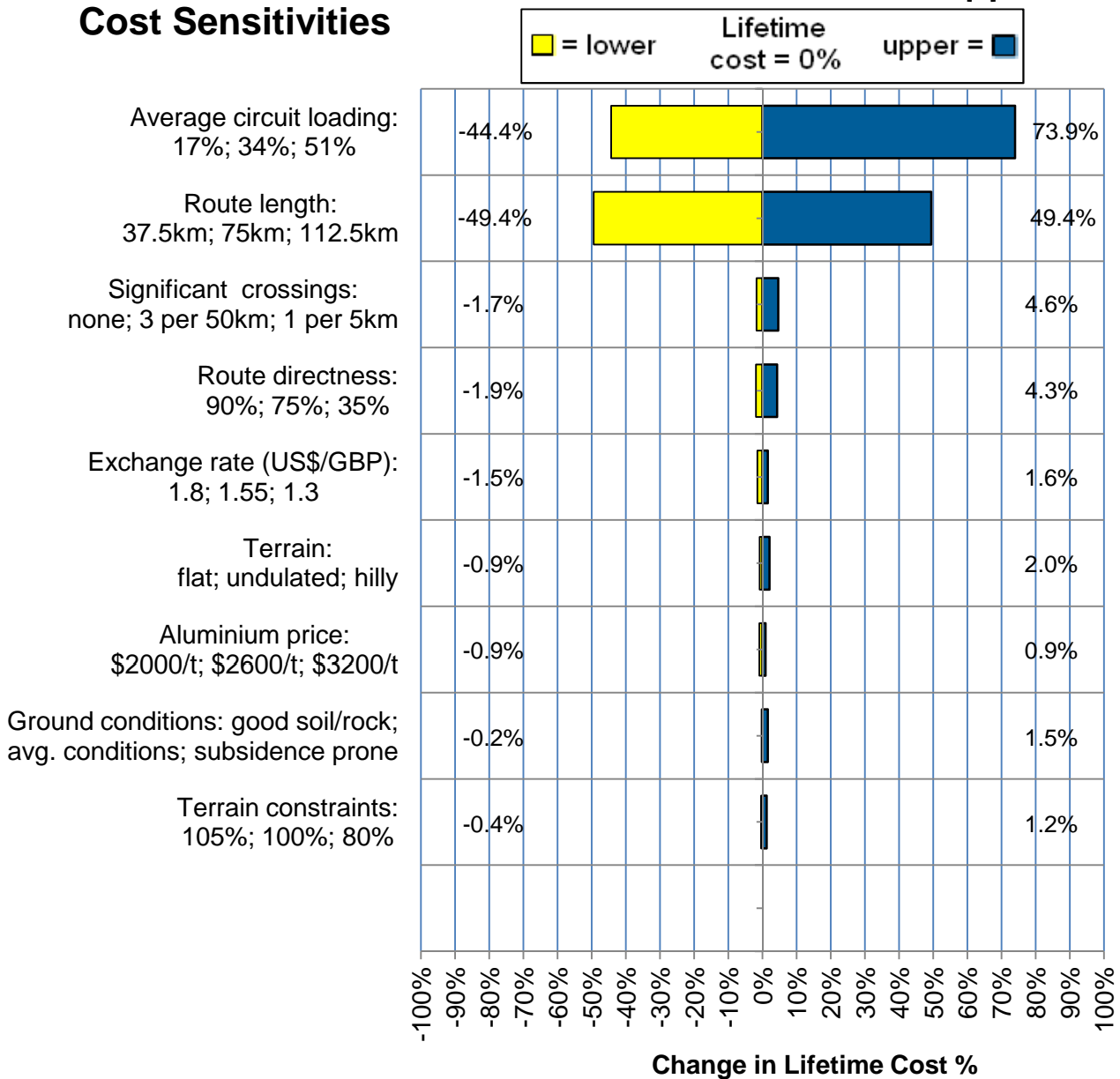

Lifetime Cost Results (£4.0m/km; £630/MVA-km)

| | | | | | | | | | | | |
|---|---|------------------------|-----------------------------|--------------------|---|----------------|------------------------------|---------|-------------------------------|----------------|---|
| <table style="width: 100%; border-collapse: collapse;"> <tr> <td style="padding: 2px;">Fixed Build Cost</td> <td style="text-align: right; padding: 2px;">£2.9m</td> </tr> <tr> <td style="padding: 2px;">Variable Build Cost</td> <td style="text-align: right; padding: 2px;">£115.3m</td> </tr> <tr> <td style="padding: 2px;">Build Cost Total for 75km</td> <td style="text-align: right; padding: 2px;">£118.2m</td> </tr> <tr> <td style="padding: 2px;">plus Variable Operating Cost</td> <td style="text-align: right; padding: 2px;">£181.6m</td> </tr> <tr> <td style="padding: 2px;">Lifetime Cost for 75km</td> <td style="text-align: right; padding: 2px;">£299.8m</td> </tr> </table> | Fixed Build Cost | £2.9m | Variable Build Cost | £115.3m | Build Cost Total for 75km | £118.2m | plus Variable Operating Cost | £181.6m | Lifetime Cost for 75km | £299.8m | <p>Other Results</p> <p>Losses = 59% of Lifetime Cost for 75km</p> <p>Costs most sensitive to:</p> <ul style="list-style-type: none"> • Average circuit loading: -44.4% to 73.9% • Route length: -49.4% to 49.4% |
| Fixed Build Cost | £2.9m | | | | | | | | | | |
| Variable Build Cost | £115.3m | | | | | | | | | | |
| Build Cost Total for 75km | £118.2m | | | | | | | | | | |
| plus Variable Operating Cost | £181.6m | | | | | | | | | | |
| Lifetime Cost for 75km | £299.8m | | | | | | | | | | |
| | | | | | | | | | | | |
| <table style="width: 100%; border-collapse: collapse;"> <tr> <td style="padding: 2px;">Lifetime Cost for 75km divided by route length</td> <td style="text-align: right; padding: 2px;">£299.8m ÷ 75km</td> </tr> <tr> <td style="padding: 2px;">Lifetime Cost per km</td> <td style="text-align: right; padding: 2px;">£4.0m/km</td> </tr> </table> | Lifetime Cost for 75km divided by route length | £299.8m ÷ 75km | Lifetime Cost per km | £4.0m/km | | | | | | | |
| Lifetime Cost for 75km divided by route length | £299.8m ÷ 75km | | | | | | | | | | |
| Lifetime Cost per km | £4.0m/km | | | | | | | | | | |
| | | | | | | | | | | | |
| <table style="width: 100%; border-collapse: collapse;"> <tr> <td style="padding: 2px;">Lifetime Cost per km divided by Power Transfer</td> <td style="text-align: right; padding: 2px;">£4.0m/km ÷ 6380 MVA</td> </tr> <tr> <td style="padding: 2px;">Lifetime PTC* per km</td> <td style="text-align: right; padding: 2px;">£630/MVA-km</td> </tr> </table> | Lifetime Cost per km divided by Power Transfer | £4.0m/km ÷ 6380 MVA | Lifetime PTC* per km | £630/MVA-km | <p>Notes (Jan-12)</p> <p>* PTC = Power Transfer Cost</p> | | | | | | |
| Lifetime Cost per km divided by Power Transfer | £4.0m/km ÷ 6380 MVA | | | | | | | | | | |
| Lifetime PTC* per km | £630/MVA-km | | | | | | | | | | |

AC Overhead Line

75km Route Lifetime Cost: £301.5m

Hi capacity (6930 MVA); 400 kV AC

Fixed Build Costs (£3.2m)

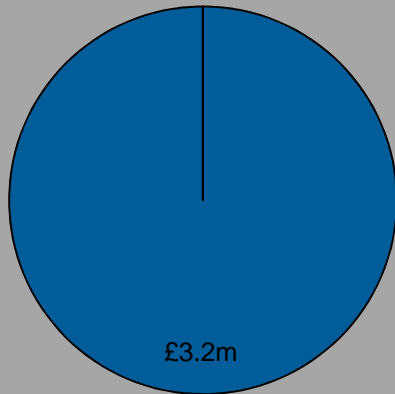

■ Mobilisation extras - £3.2m

Variable Build Costs (£131.4m)

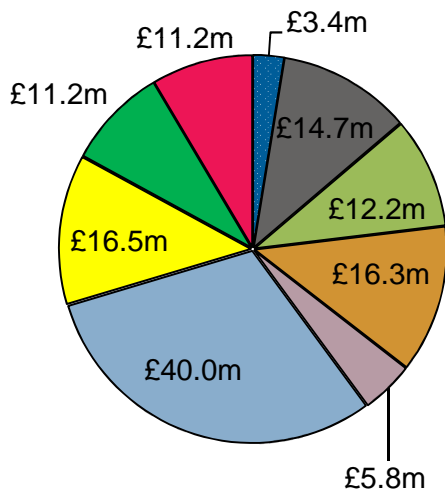

- Foundations total - £3.4m
- Tower materials - £14.7m
- Conductors + OPGW materials - £12.2m
- Access roads total - £16.3m
- Insulators + fittings materials - £5.8m
- Erection of towers + stringing - £40.0m
- Engineering & safety - £16.5m
- Project launch + mgmt. (10%) - £11.2m
- Build contingency (10%) - £11.2m

Variable Operating Costs (£166.9m)

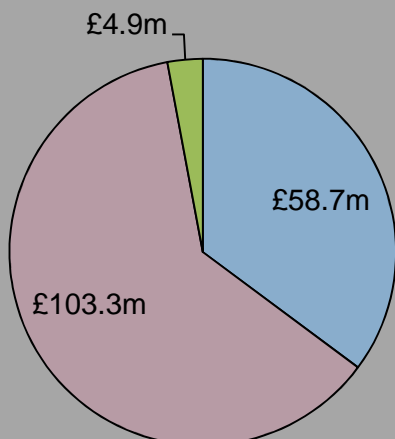

- Cost of power losses - £58.7m (power stations)
- Cost of energy losses - £103.3m (fuel)
- Operation & maintenance - £4.9m

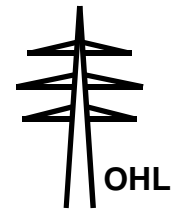

Cost Sensitivities

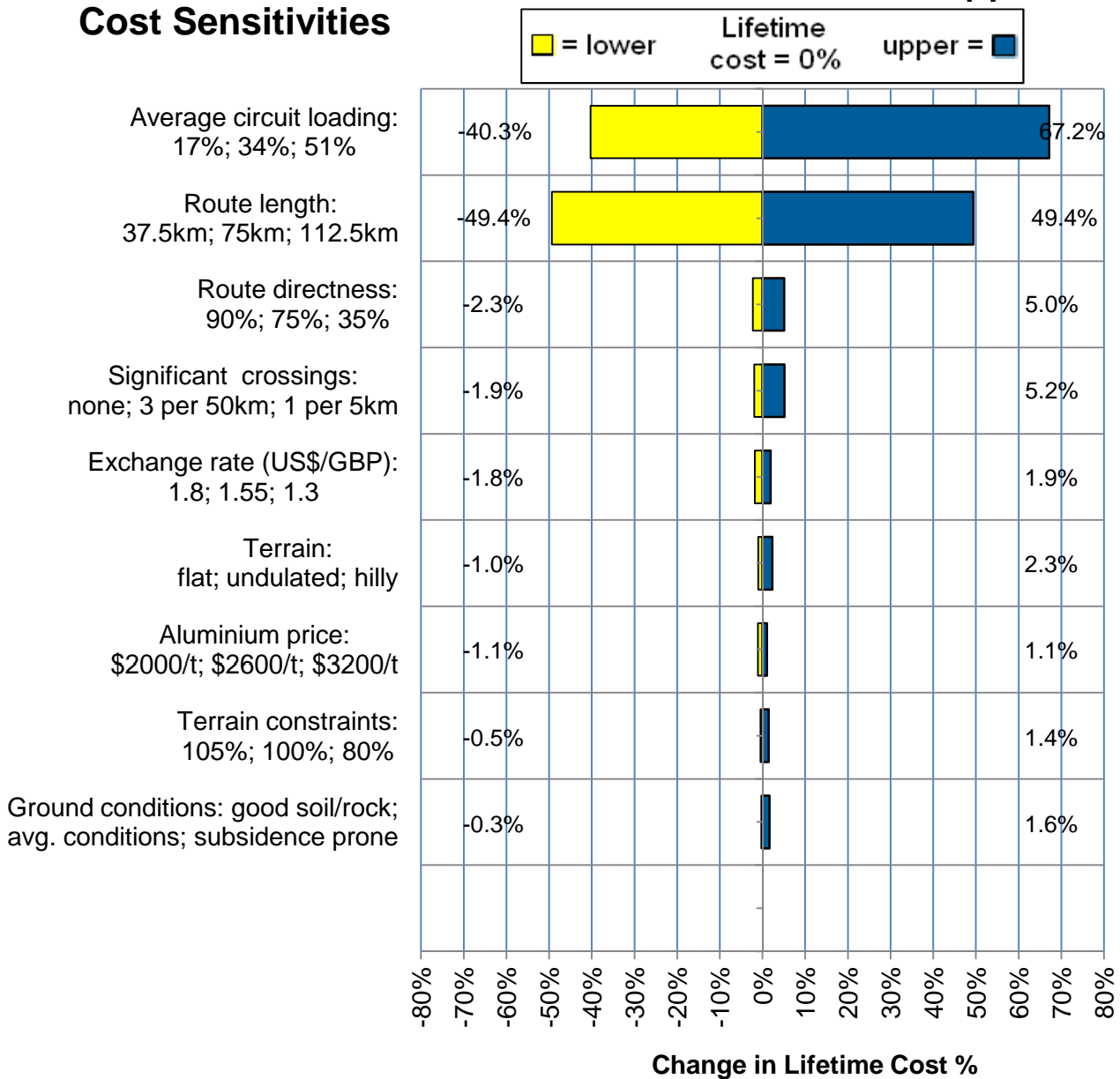

Lifetime Cost Results (£4.0m/km; £580/MVA-km)

| | | |
|---|------------------------|---|
| Fixed Build Cost | £3.2m | Other Results Losses = 54% of Lifetime Cost for 75km Costs most sensitive to: <ul style="list-style-type: none"> Average circuit loading: -40.3% to 67.2% Route length: -49.4% to 49.4% |
| Variable Build Cost | £131.4m | |
| Build Cost Total for 75km | £134.6m | |
| plus Variable Operating Cost | £166.9m | |
| Lifetime Cost for 75km | £301.5m | Notes (Jan-12) * PTC = Power Transfer Cost |
| Lifetime Cost for 75km divided by route length | £301.5m ÷ 75km | |
| Lifetime Cost per km | £4.0m/km | |
| Lifetime Cost per km divided by Power Transfer | £4.0m/km ÷ 6930 MVA | |
| Lifetime PTC* per km | £580/MVA-km | |

Cost charts for underground cable

The following charts present the lifetime cost make-up and associated sensitivities on lifetime cost for the underground cable electricity transmission options: direct-buried and in tunnels.

Figure 3 – 400kV cable tunnel crossing beneath the Thames at Dartford



(Photo courtesy of Cable Consulting International)

AC Underground Cable (direct-buried)

3km Route Lifetime Cost: £38.4m

Lo capacity (3190 MVA); 400 kV AC

Fixed Build Costs (£5.8m)

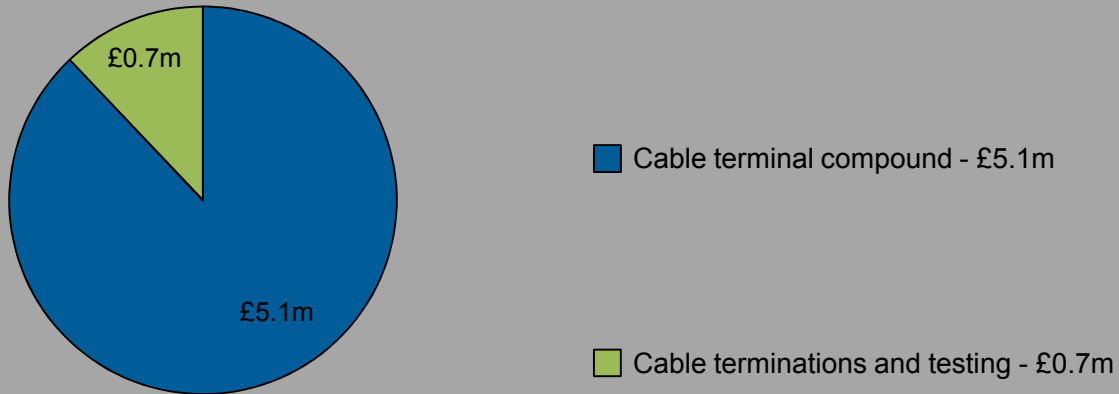

Variable Build Costs (£29.7m)

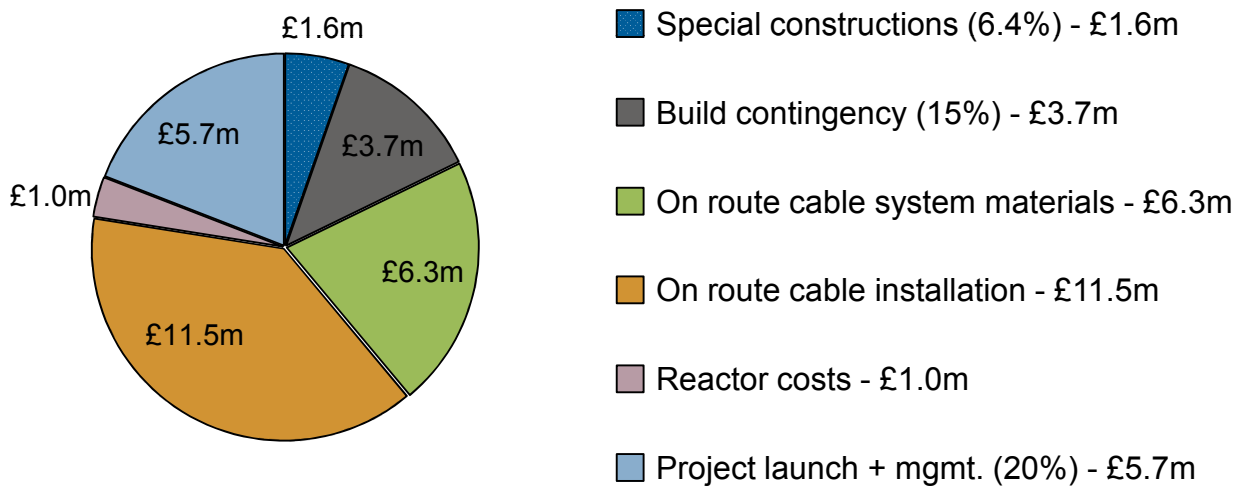

Variable Operating Costs (£2.8m)

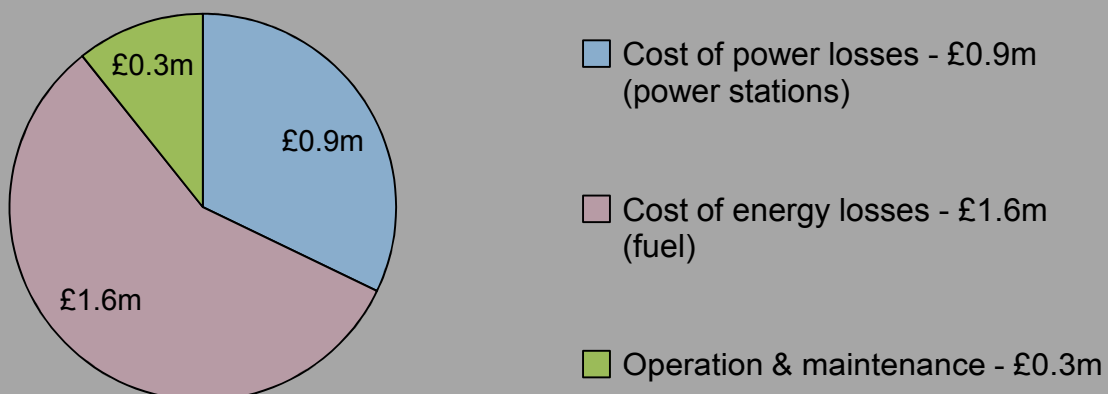



Cost Sensitivities

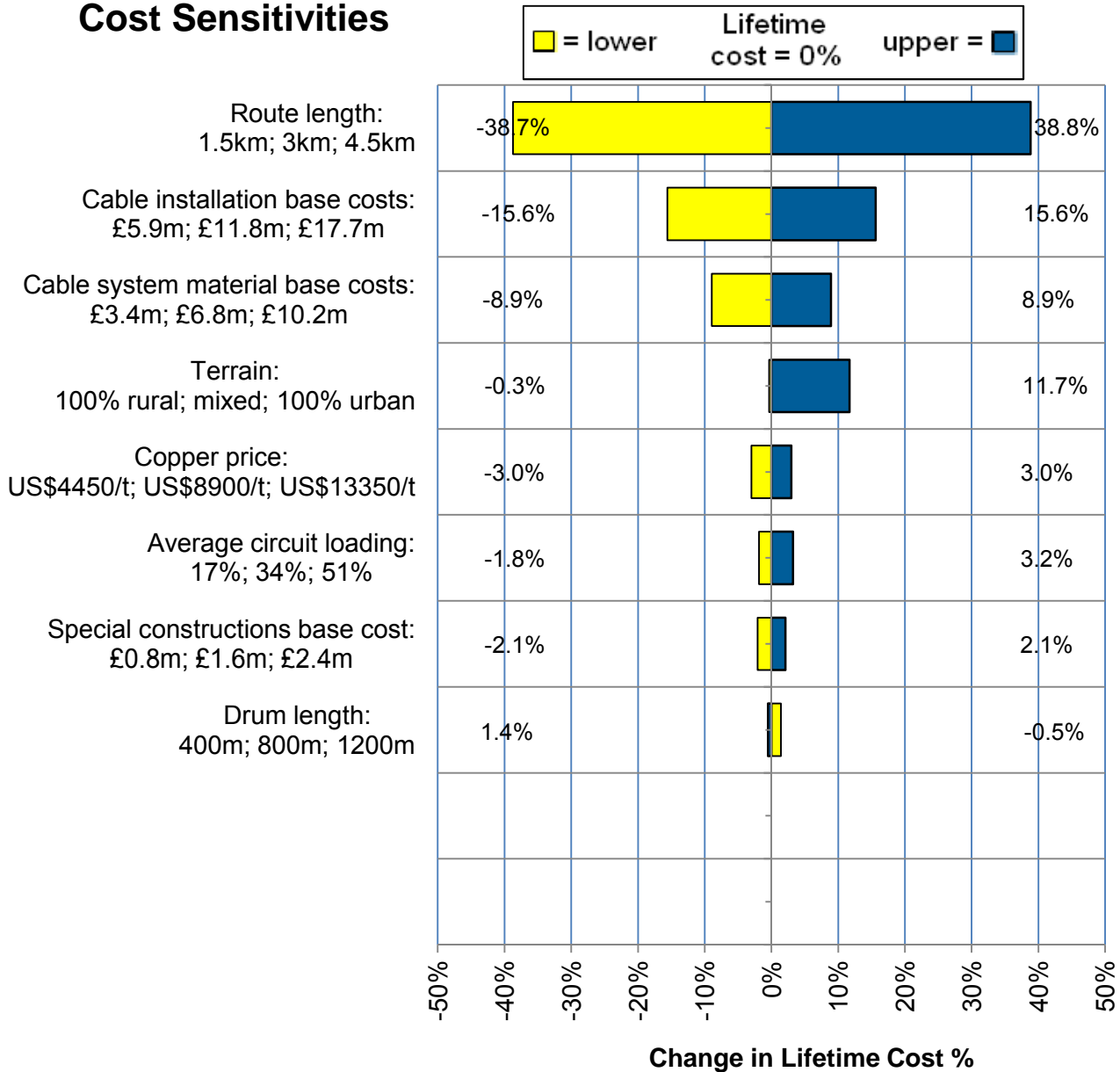

Underground cable

Lifetime Cost Results (£12.8m/km; £4010/MVA-km)

| | |
|---------------------------------|---------------|
| Fixed Build Cost | £5.8m |
| Variable Build Cost | £29.7m |
| Build Cost Total for 3km | £35.5m |
| plus Variable Operating Cost | £2.8m |
| Lifetime Cost for 3km | £38.4m |

| | |
|-----------------------------|------------------|
| Lifetime Cost for 3km | £38.4m |
| divided by route length | ÷ 3km |
| Lifetime Cost per km | £12.8m/km |

| | |
|-----------------------------|---------------------|
| Lifetime Cost per km | £12.8m/km |
| divided by Power Transfer | ÷ 3190 MVA |
| Lifetime PTC* per km | £4010/MVA-km |

Other Results

Losses = 7% of Lifetime Cost for 3km

Costs most sensitive to:

- Route length:
-38.7% to 38.8%
- Cable installation base costs:
-15.6% to 15.6%

Notes (Jan-12)

* PTC = Power Transfer Cost

AC Underground Cable (direct-buried)

3km Route Lifetime Cost: £67.6m

Med capacity (6380 MVA); 400 kV AC

Fixed Build Costs (£8.5m)

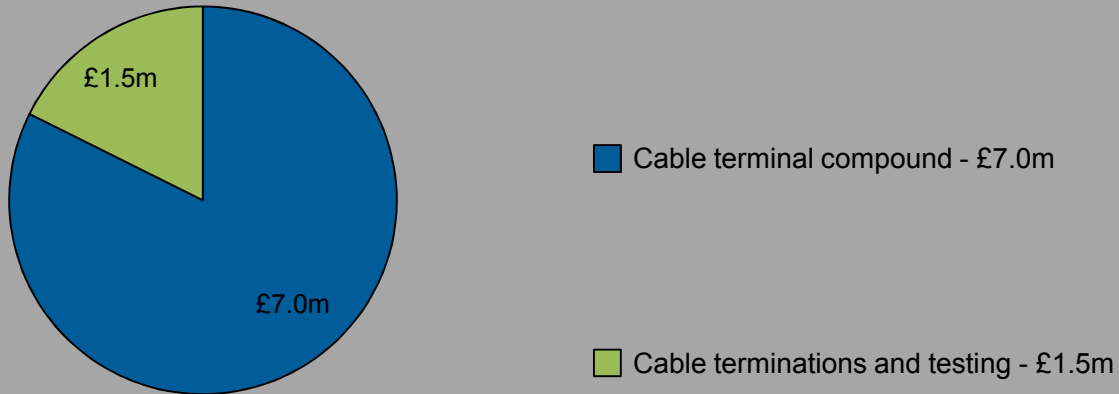

Variable Build Costs (£53.3m)

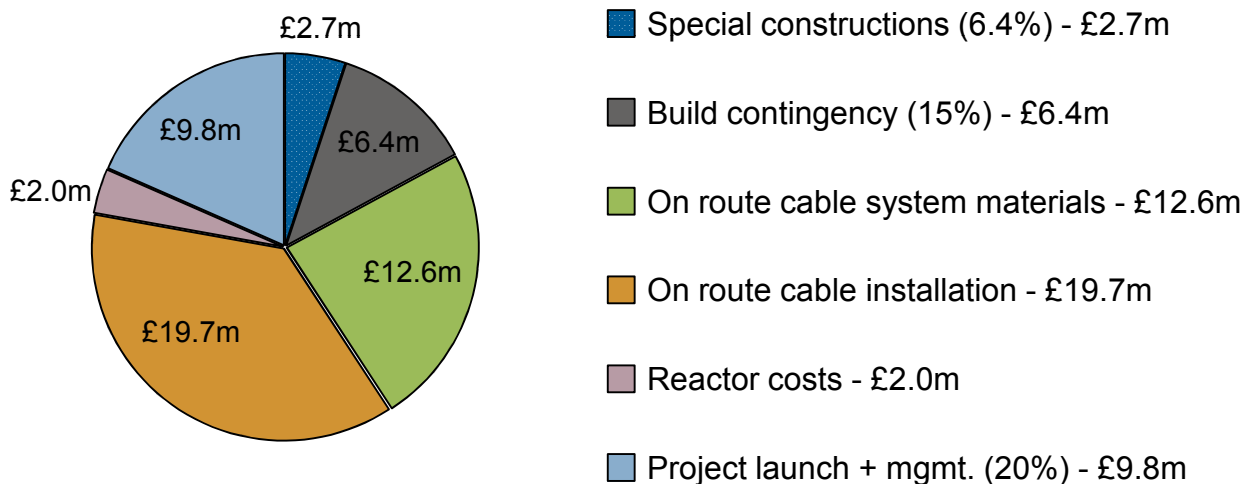

Variable Operating Costs (£5.9m)

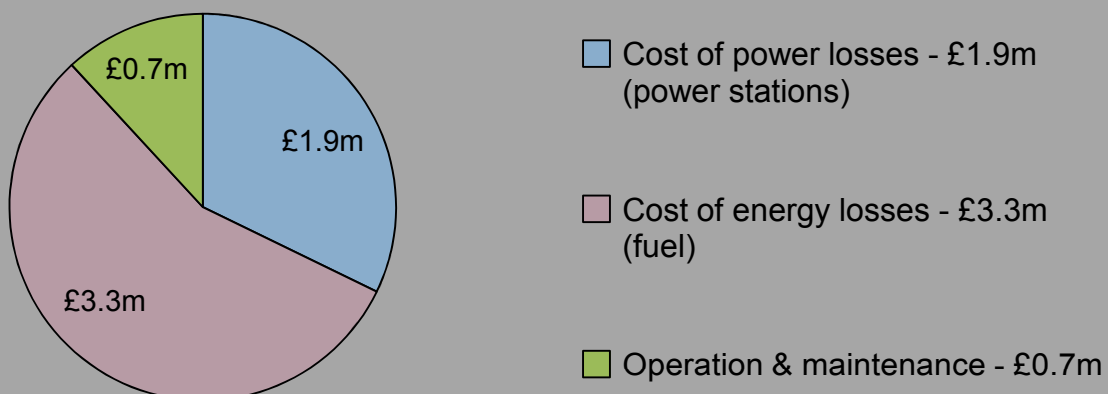

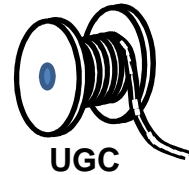

Cost Sensitivities

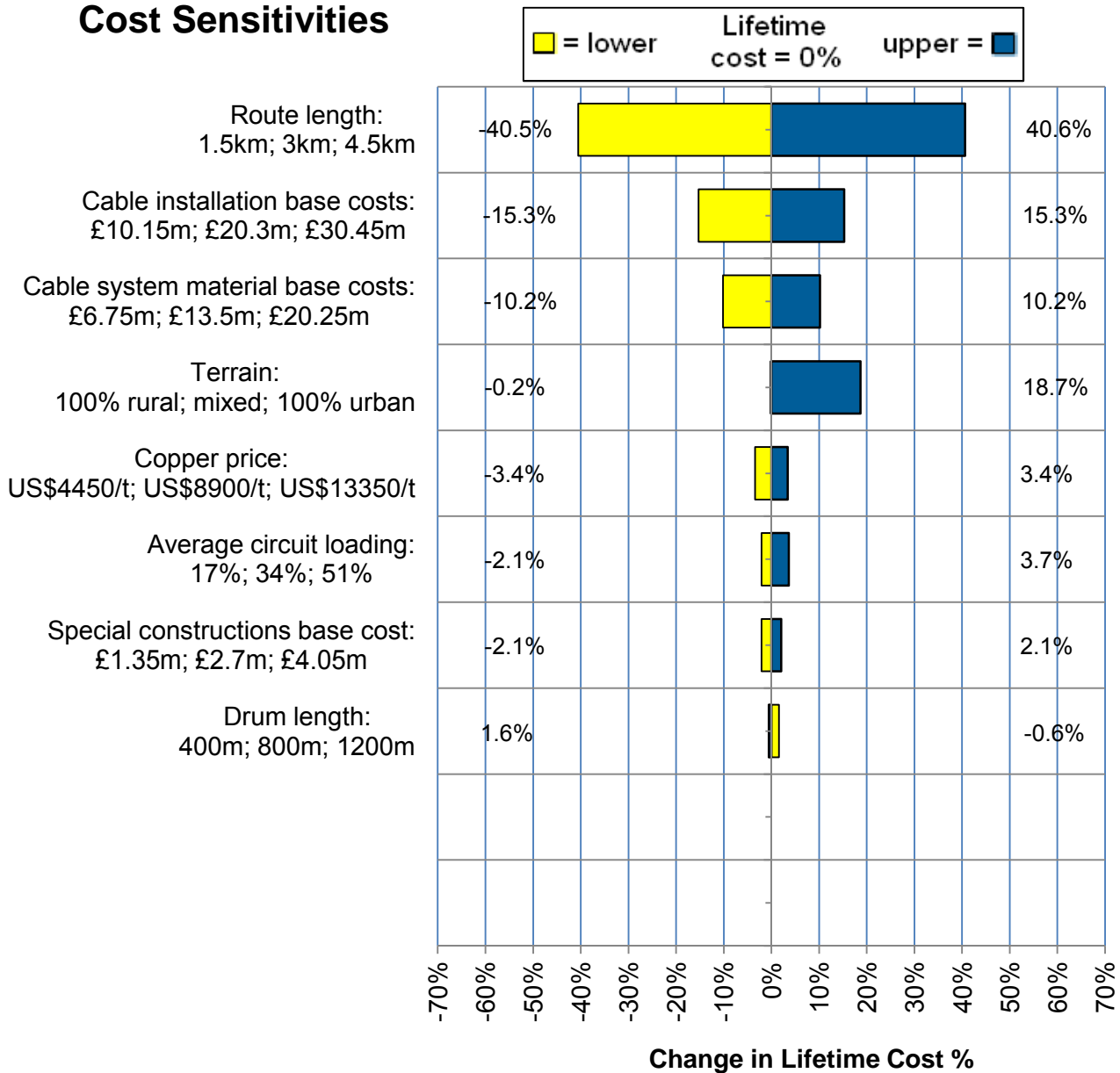

Underground cable

Lifetime Cost Results (£22.5m/km; £3530/MVA-km)

| | |
|---------------------------------|---------------|
| Fixed Build Cost | £8.5m |
| Variable Build Cost | £53.3m |
| Build Cost Total for 3km | £61.8m |
| plus Variable Operating Cost | £5.9m |
| Lifetime Cost for 3km | £67.6m |

| | |
|---|------------------|
| Lifetime Cost for 3km divided by route length ÷ 3km | £67.6m ÷ 3km |
| Lifetime Cost per km | £22.5m/km |

| | |
|---|----------------------|
| Lifetime Cost per km divided by Power Transfer ÷ 6380 MVA | £22.5m/km ÷ 6380 MVA |
| Lifetime PTC* per km | £3530/MVA-km |

Other Results

Losses = 8% of Lifetime Cost for 3km

Costs most sensitive to:

- Route length: -40.5% to 40.6%
- Cable installation base costs: -15.3% to 15.3%

Notes (Jan-12)

* PTC = Power Transfer Cost

AC Underground Cable (direct-buried)

3km Route Lifetime Cost: £72.2m

Hi capacity (6930 MVA); 400 kV AC

Fixed Build Costs (£8.5m)

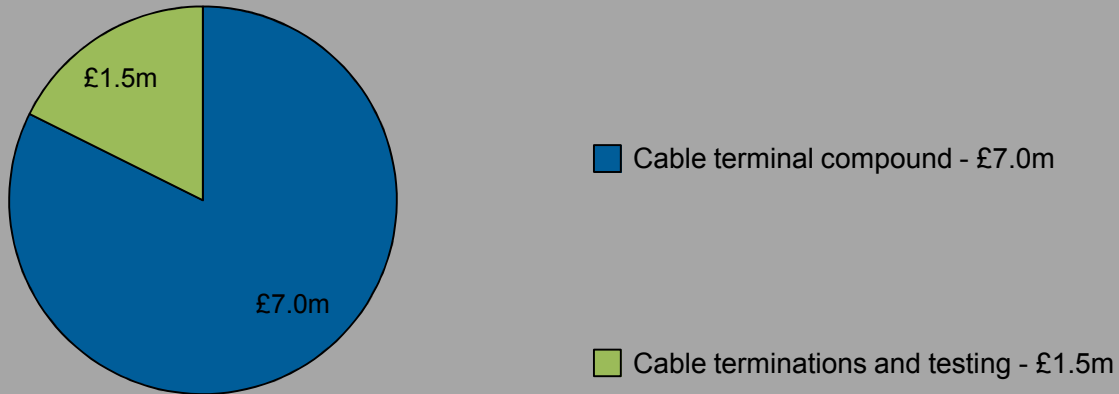

Variable Build Costs (£57.6m)

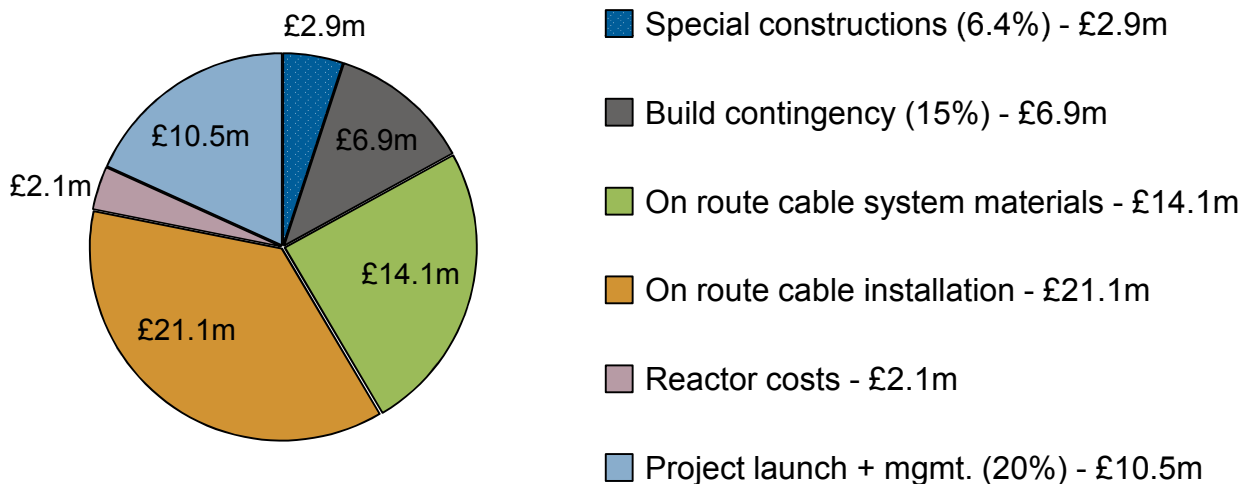

Variable Operating Costs (£6.1m)

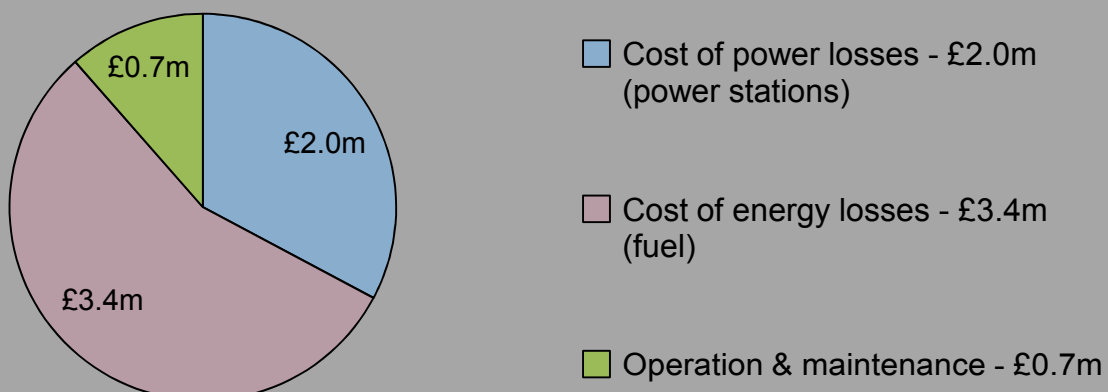



Cost Sensitivities

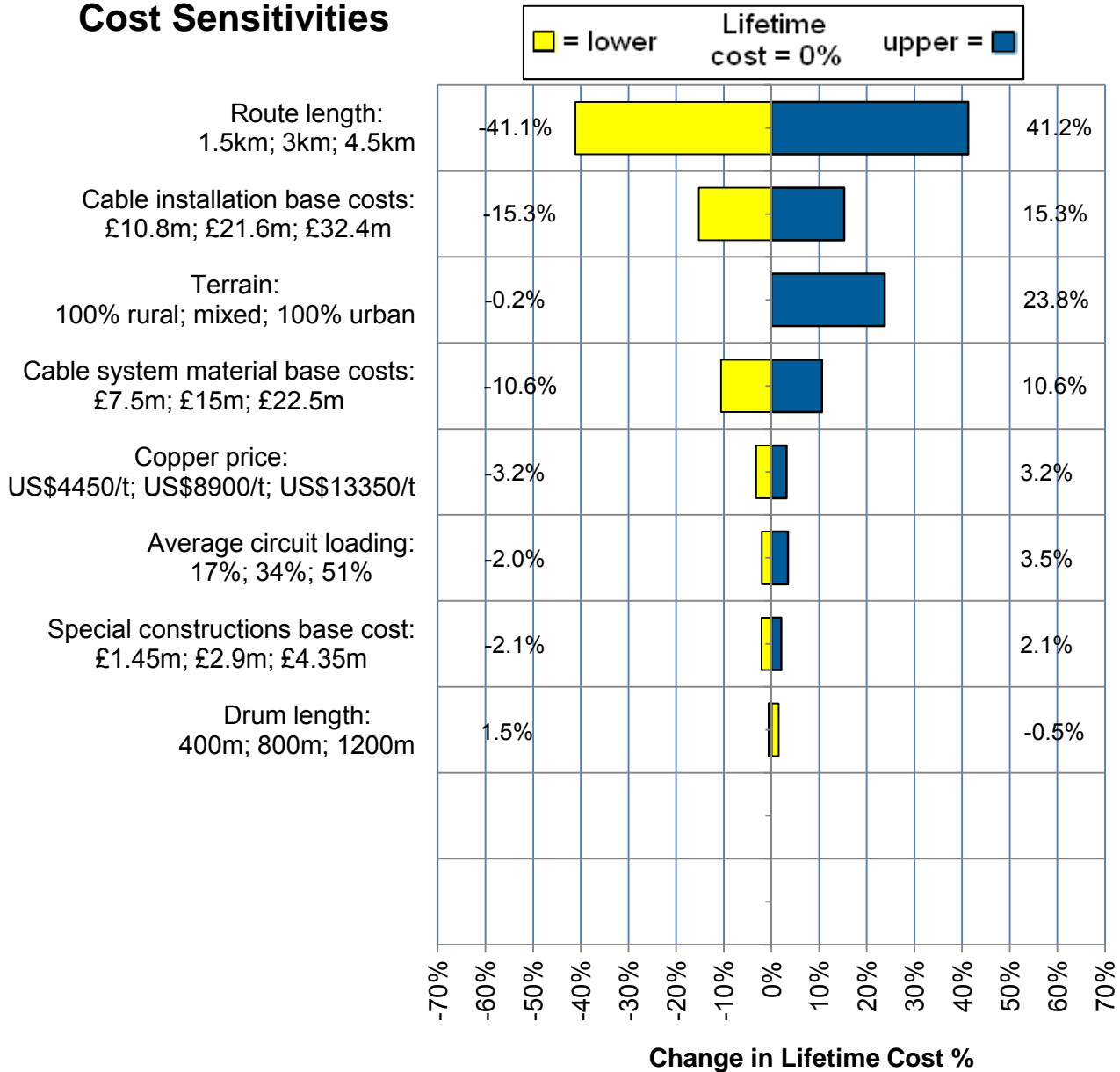

Underground
cable

Lifetime Cost Results (£24.1m/km; £3470/MVA-km)

| | |
|---------------------------------|---------------|
| Fixed Build Cost | £8.5m |
| Variable Build Cost | £57.6m |
| Build Cost Total for 3km | £66.1m |
| plus Variable Operating Cost | £6.1m |
| Lifetime Cost for 3km | £72.2m |

| | |
|---|------------------|
| Lifetime Cost for 3km divided by route length ÷ 3km | £72.2m |
| Lifetime Cost per km | £24.1m/km |

| | |
|---|---------------------|
| Lifetime Cost per km divided by Power Transfer ÷ 6930 MVA | £24.1m/km |
| Lifetime PTC* per km | £3470/MVA-km |

Other Results

Losses = 7% of Lifetime Cost for 3km

Costs most sensitive to:

- Route length:
-41.1% to 41.2%
- Cable installation base costs:
-15.3% to 15.3%

Notes (Jan-12)

* PTC = Power Transfer Cost

AC Underground Cable (direct-buried)

15km Route Lifetime Cost: £158.9m

Lo capacity (3190 MVA); 400 kV AC

Fixed Build Costs (£5.8m)

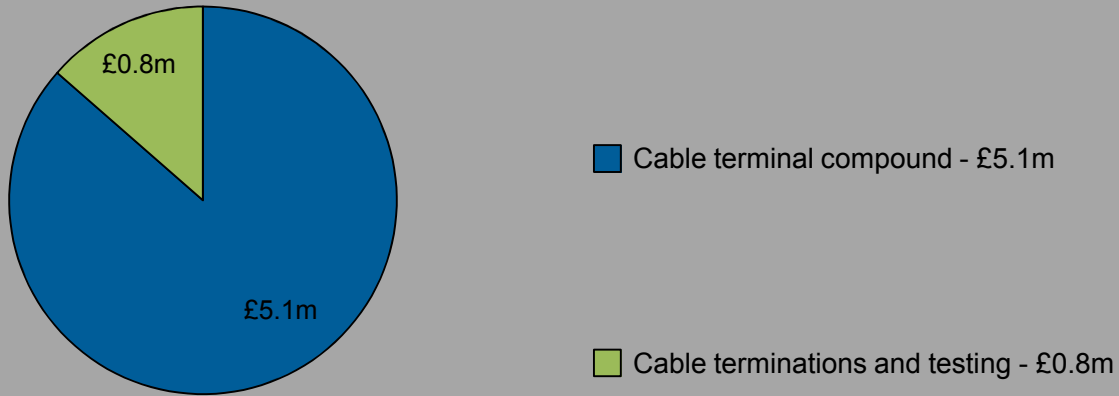

Variable Build Costs (£138.4m)

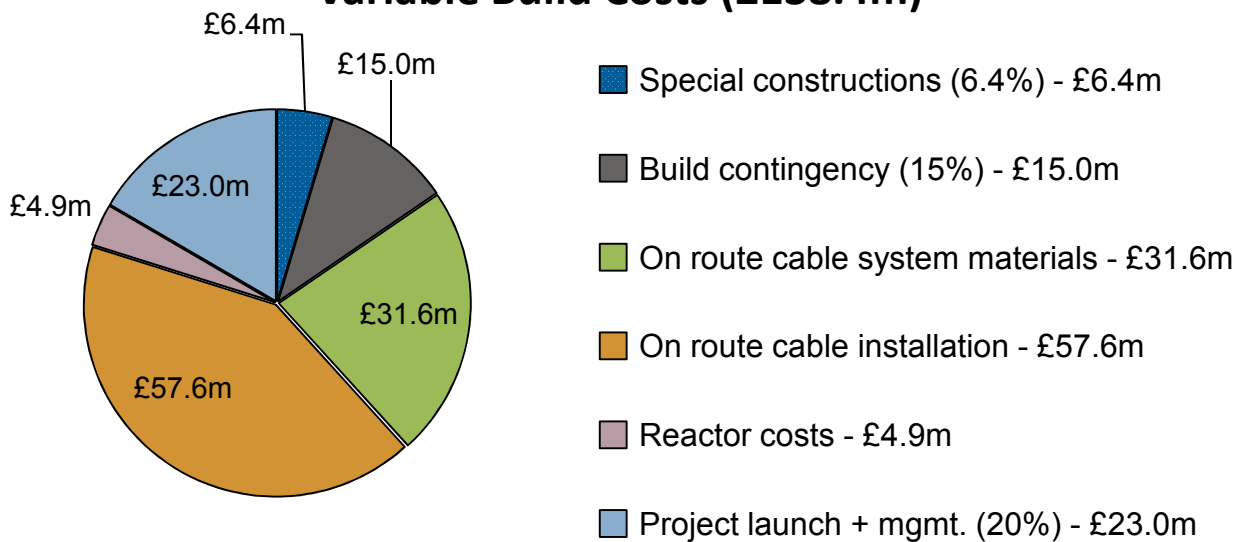

Variable Operating Costs (£14.6m)

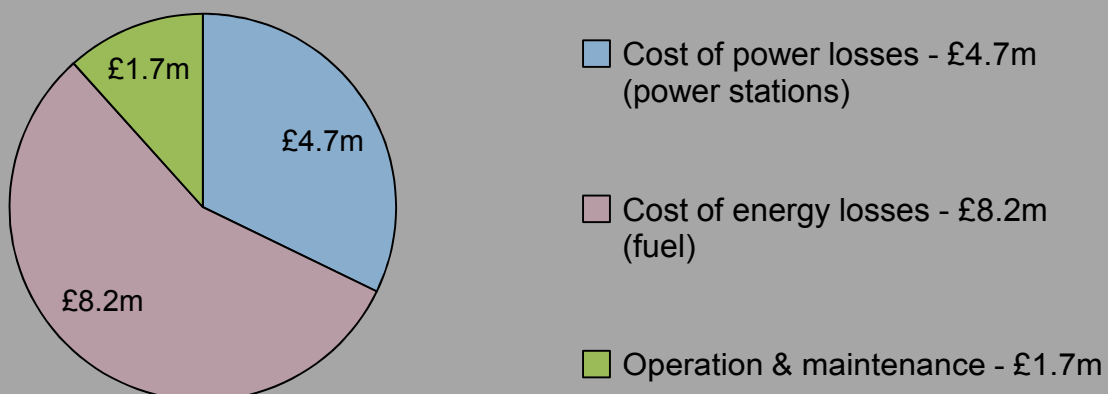

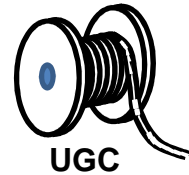

Cost Sensitivities

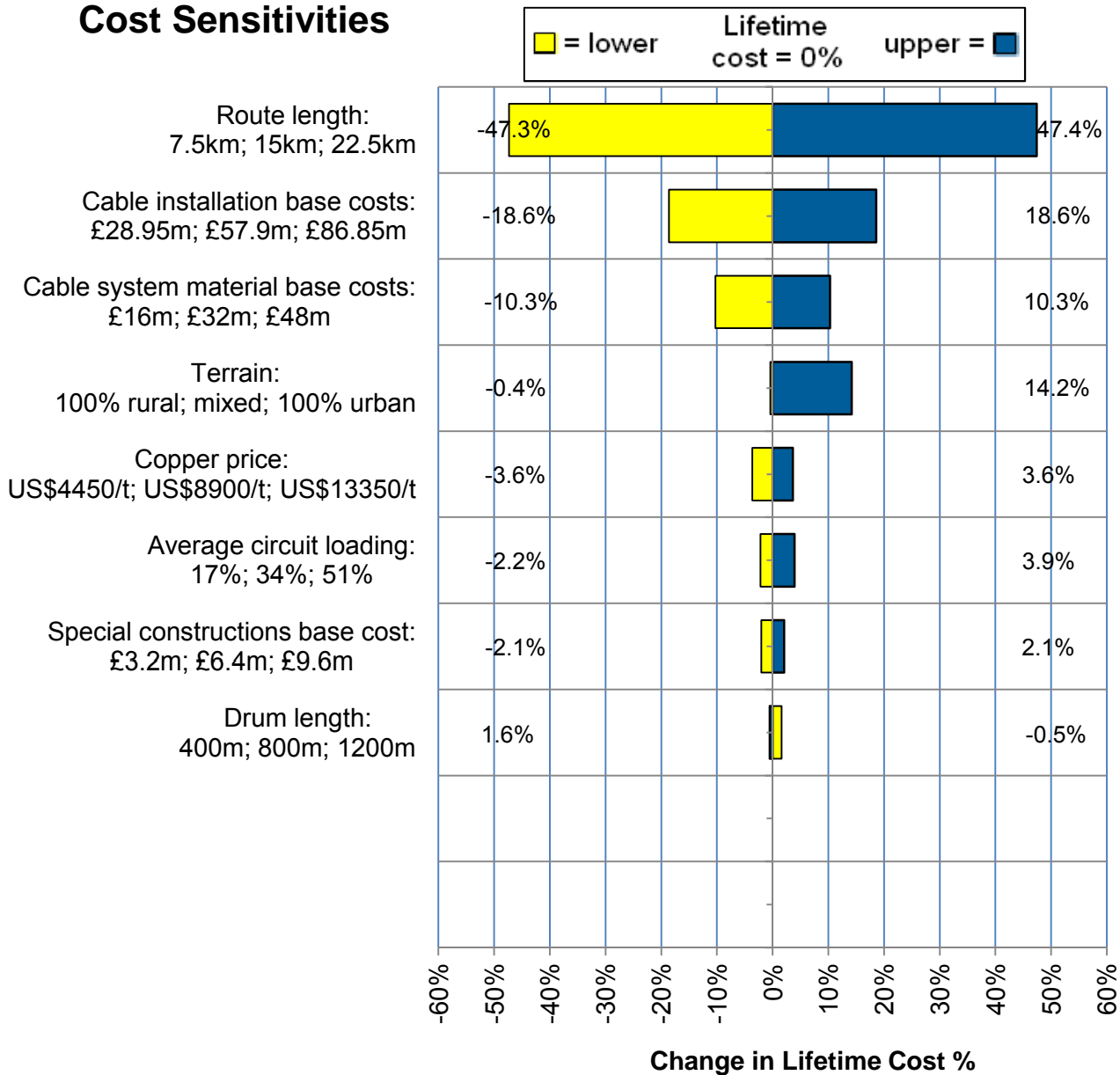

Underground cable

Lifetime Cost Results (£10.6m/km; £3320/MVA-km)

| | |
|----------------------------------|----------------|
| Fixed Build Cost | £5.8m |
| Variable Build Cost | £138.4m |
| Build Cost Total for 15km | £144.2m |
| plus Variable Operating Cost | £14.6m |
| Lifetime Cost for 15km | £158.9m |

| | |
|--|------------------|
| Lifetime Cost for 15km divided by route length | £158.9m ÷ 15km |
| Lifetime Cost per km | £10.6m/km |

| | |
|--|----------------------|
| Lifetime Cost per km divided by Power Transfer | £10.6m/km ÷ 3190 MVA |
| Lifetime PTC* per km | £3320/MVA-km |

Other Results

Losses = 8% of Lifetime Cost for 15km

Costs most sensitive to:

- Route length:
-47.3% to 47.4%
- Cable installation base costs:
-18.6% to 18.6%

Notes (Jan-12)

* PTC = Power Transfer Cost

AC Underground Cable (direct-buried)

15km Route Lifetime Cost: £289.6m

Med capacity (6380 MVA); 400 kV AC

Fixed Build Costs (£8.6m)

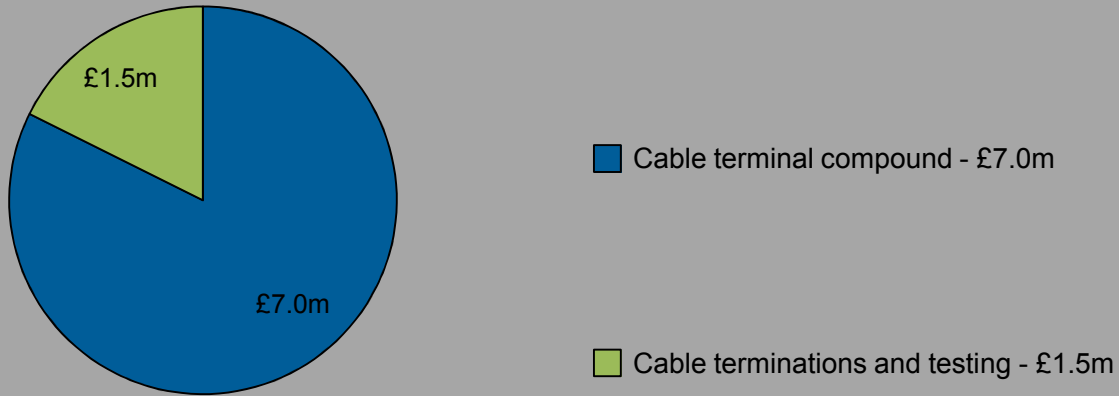

Variable Build Costs (£251.7m)

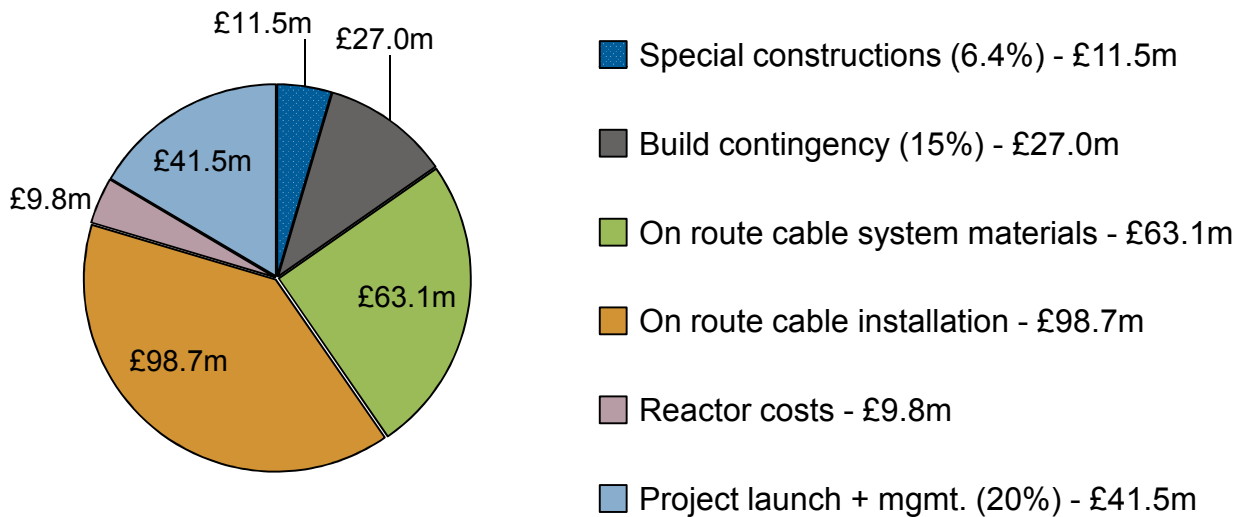

Variable Operating Costs (£29.4m)

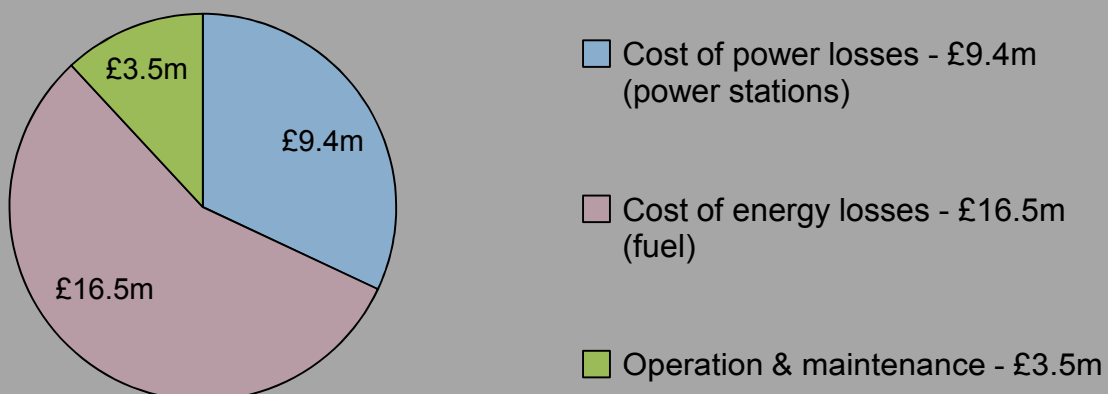

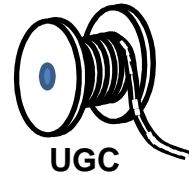

Cost Sensitivities

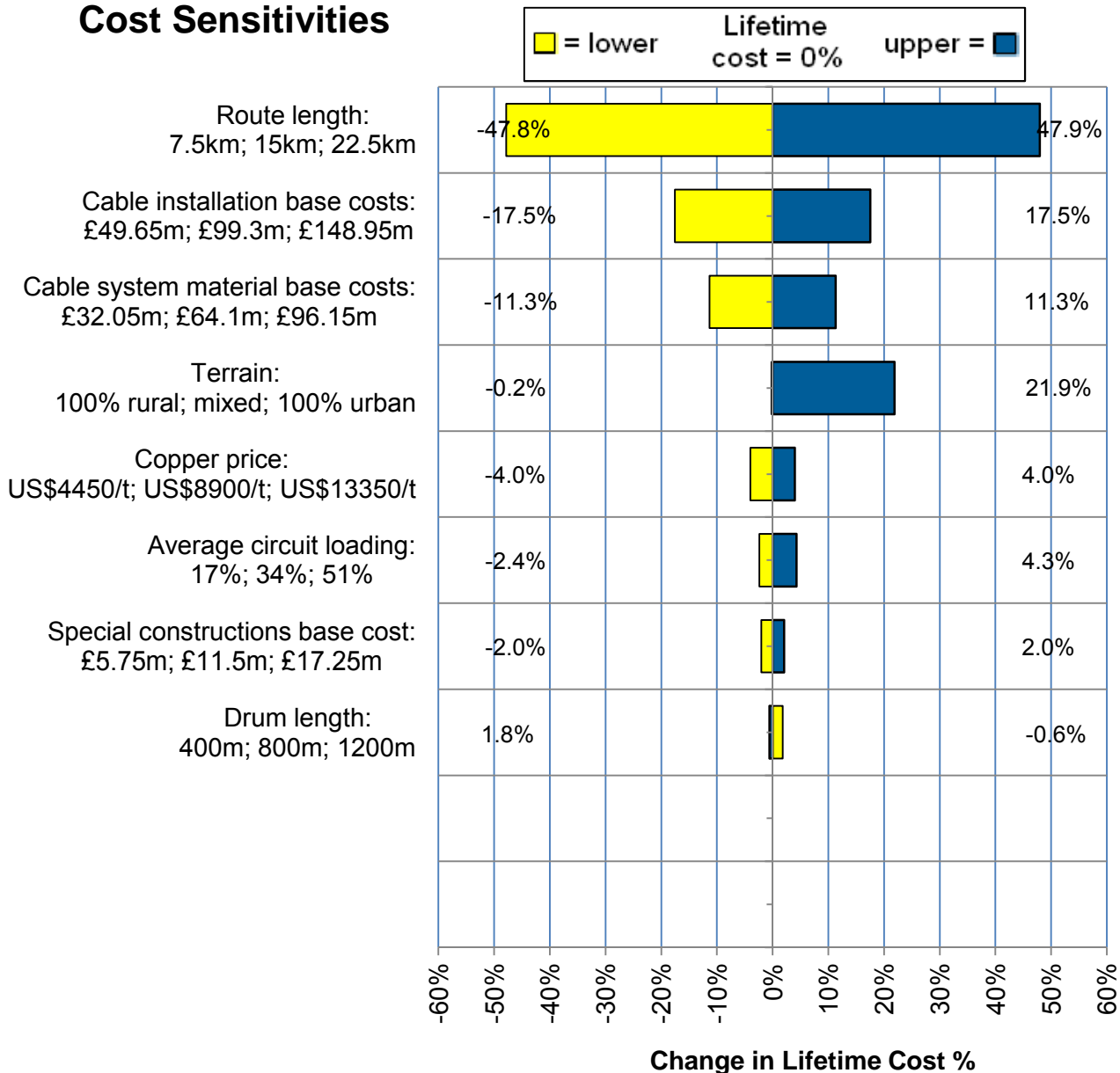

Underground cable

Lifetime Cost Results (£19.3m/km; £3030/MVA-km)

| | |
|----------------------------------|----------------|
| Fixed Build Cost | £8.6m |
| Variable Build Cost | £251.7m |
| Build Cost Total for 15km | £260.3m |
| plus Variable Operating Cost | £29.4m |
| Lifetime Cost for 15km | £289.6m |

| | |
|--|------------------|
| Lifetime Cost for 15km divided by route length | £289.6m ÷ 15km |
| Lifetime Cost per km | £19.3m/km |

| | |
|--|----------------------|
| Lifetime Cost per km divided by Power Transfer | £19.3m/km ÷ 6380 MVA |
| Lifetime PTC* per km | £3030/MVA-km |

Other Results

Losses = 9% of Lifetime Cost for 15km

Costs most sensitive to:

- Route length:
-47.8% to 47.9%
- Cable installation base costs:
-17.5% to 17.5%

Notes (Jan-12)

* PTC = Power Transfer Cost

AC Underground Cable (direct-buried)

15km Route Lifetime Cost: £312.3m

Hi capacity (6930 MVA); 400 kV AC

Fixed Build Costs (£8.6m)

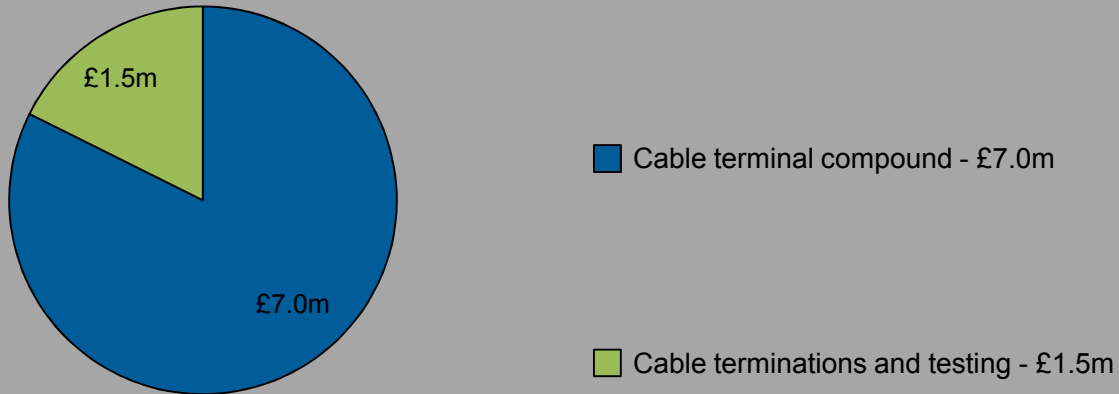

Variable Build Costs (£273.3m)

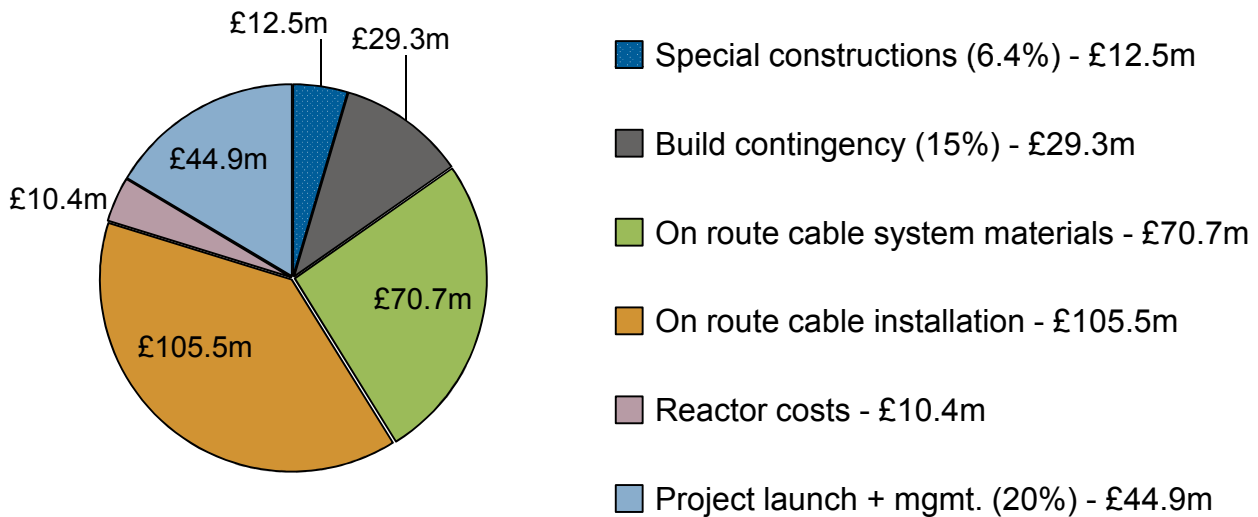

Variable Operating Costs (£30.5m)

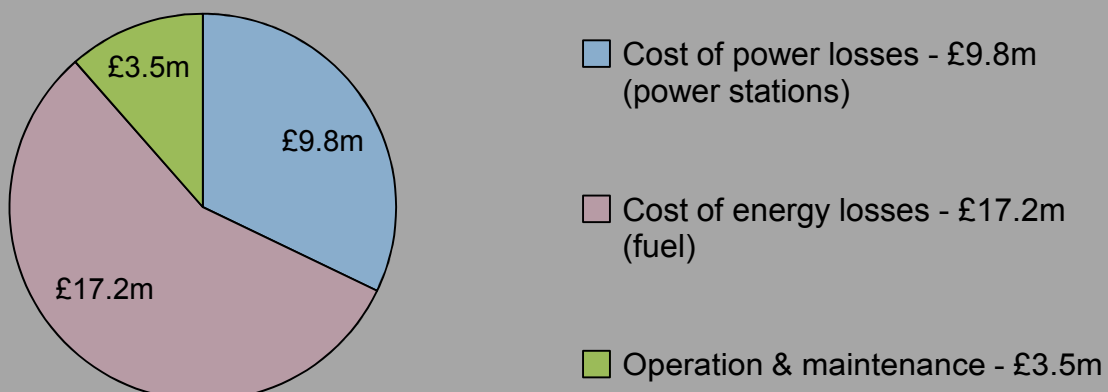

AC Underground Cable (direct-buried)

75km Route Lifetime Cost: £768.6m

Lo capacity (3190 MVA); 400 kV AC

Fixed Build Costs (£5.9m)

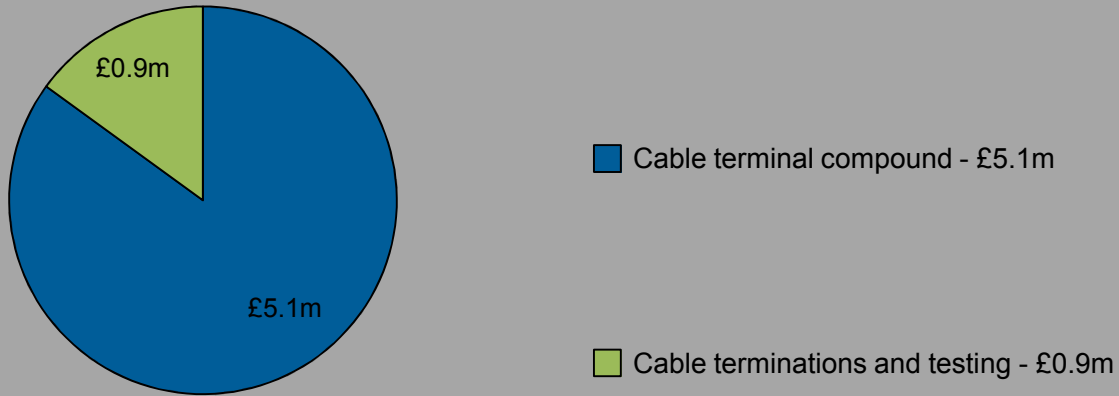

Variable Build Costs (£681.9m)

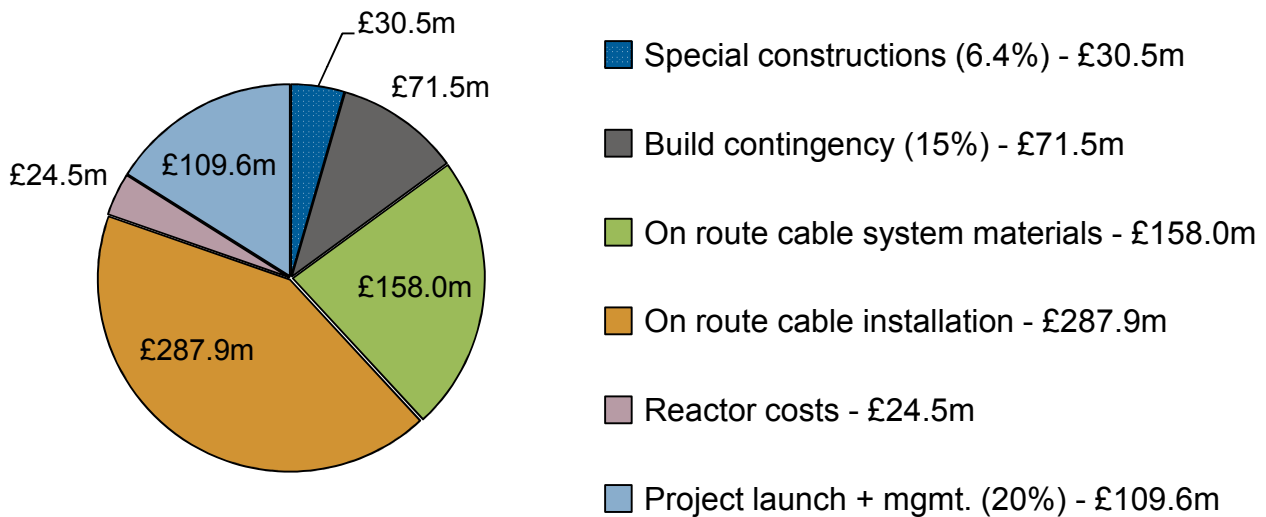

Variable Operating Costs (£80.7m)

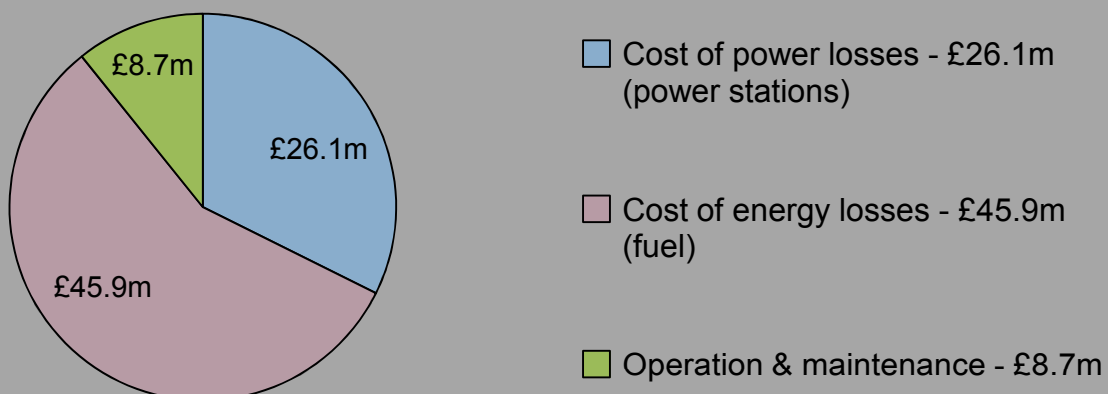

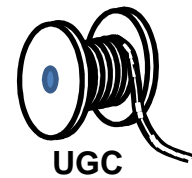

Cost Sensitivities

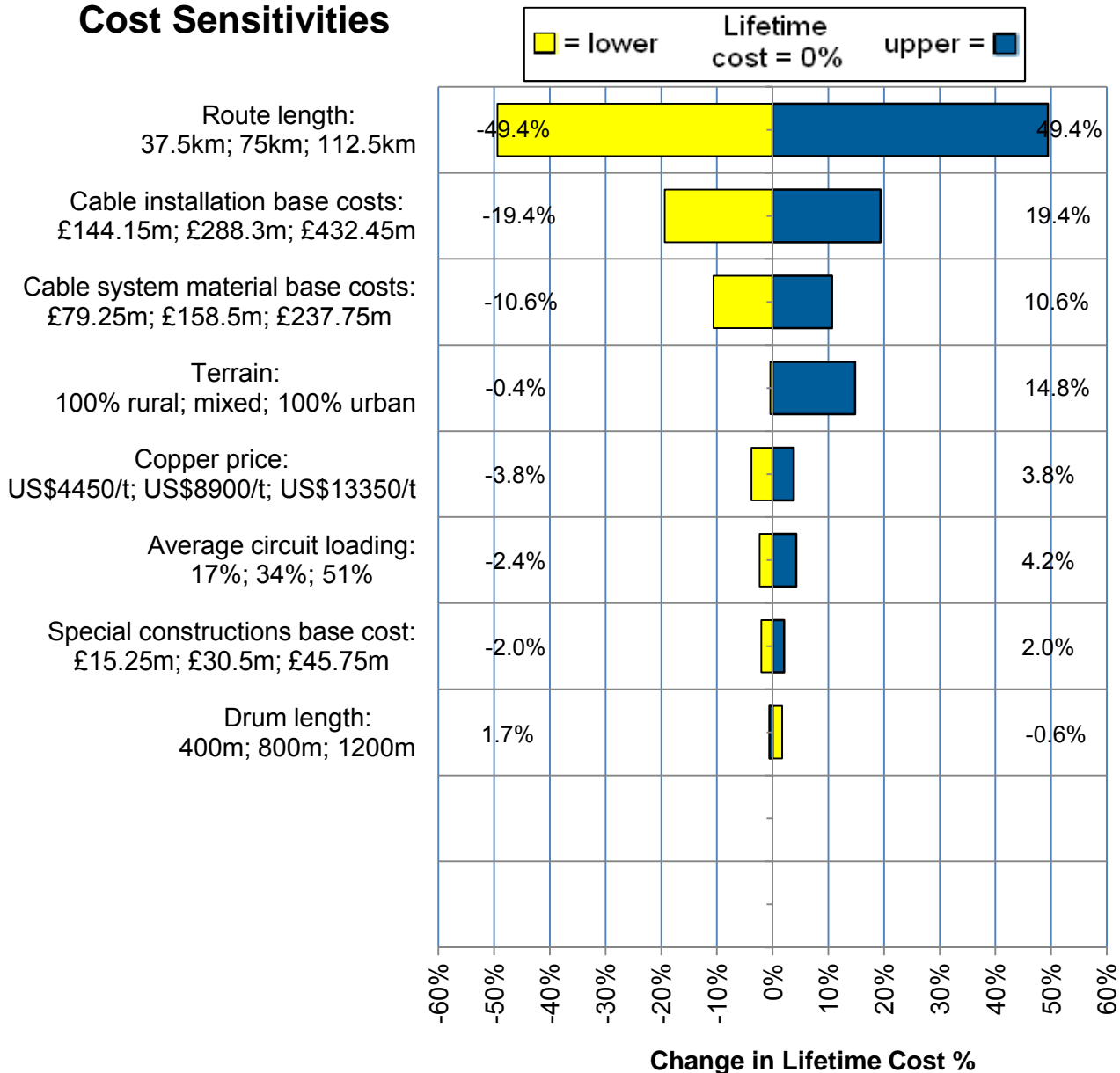

Underground cable

Lifetime Cost Results (£10.2m/km; £3210/MVA-km)

| | |
|----------------------------------|----------------|
| Fixed Build Cost | £5.9m |
| Variable Build Cost | £681.9m |
| Build Cost Total for 75km | £687.8m |
| plus Variable Operating Cost | £80.7m |
| Lifetime Cost for 75km | £768.6m |

| | |
|--|------------------|
| Lifetime Cost for 75km divided by route length | £768.6m ÷ 75km |
| Lifetime Cost per km | £10.2m/km |

| | |
|--|----------------------|
| Lifetime Cost per km divided by Power Transfer | £10.2m/km ÷ 3190 MVA |
| Lifetime PTC* per km | £3210/MVA-km |

Other Results

Losses = 9% of Lifetime Cost for 75km

Costs most sensitive to:

- Route length:
-49.4% to 49.4%
- Cable installation base costs:
-19.4% to 19.4%

Notes (Jan-12)

* PTC = Power Transfer Cost

AC Underground Cable (direct-buried)

75km Route Lifetime Cost: £1414.3m

Med capacity (6380 MVA); 400 kV AC

Fixed Build Costs (£8.8m)

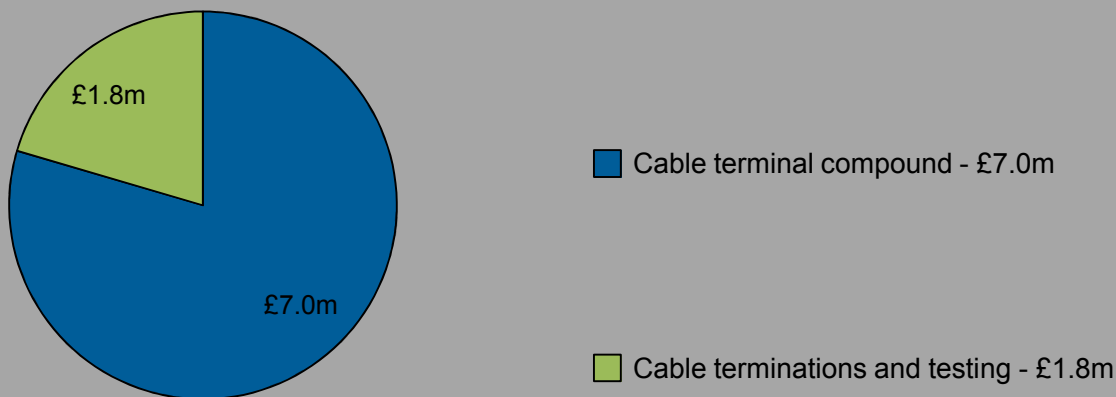

Variable Build Costs (£1243.9m)

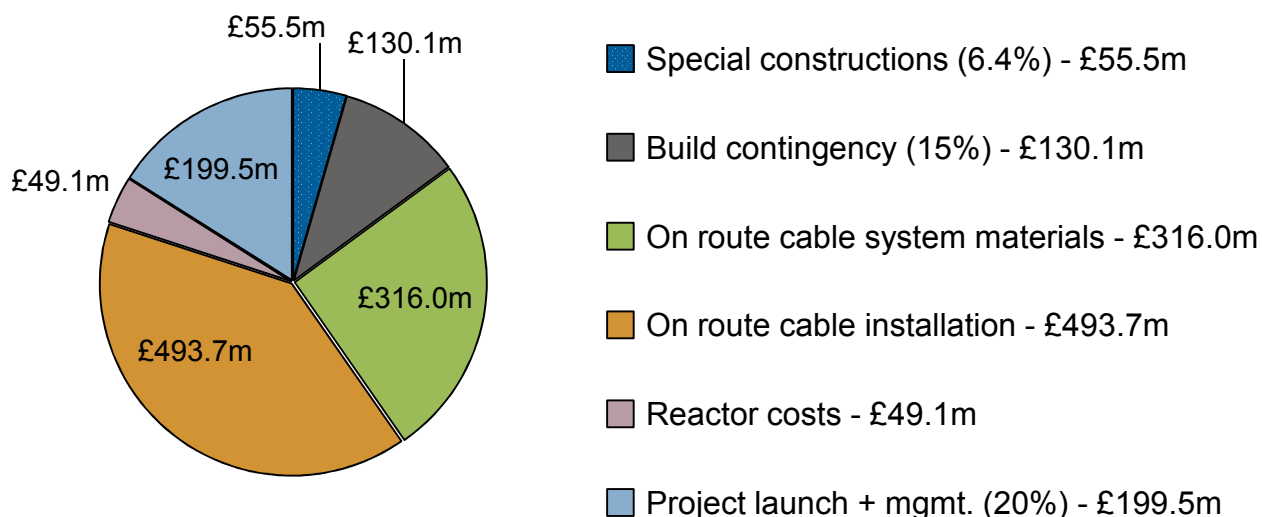

Variable Operating Costs (£161.6m)

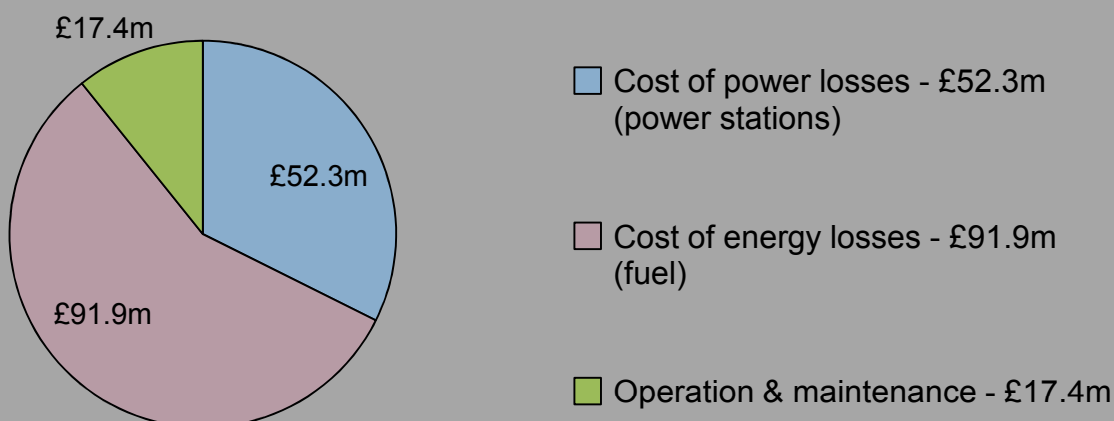



Cost Sensitivities

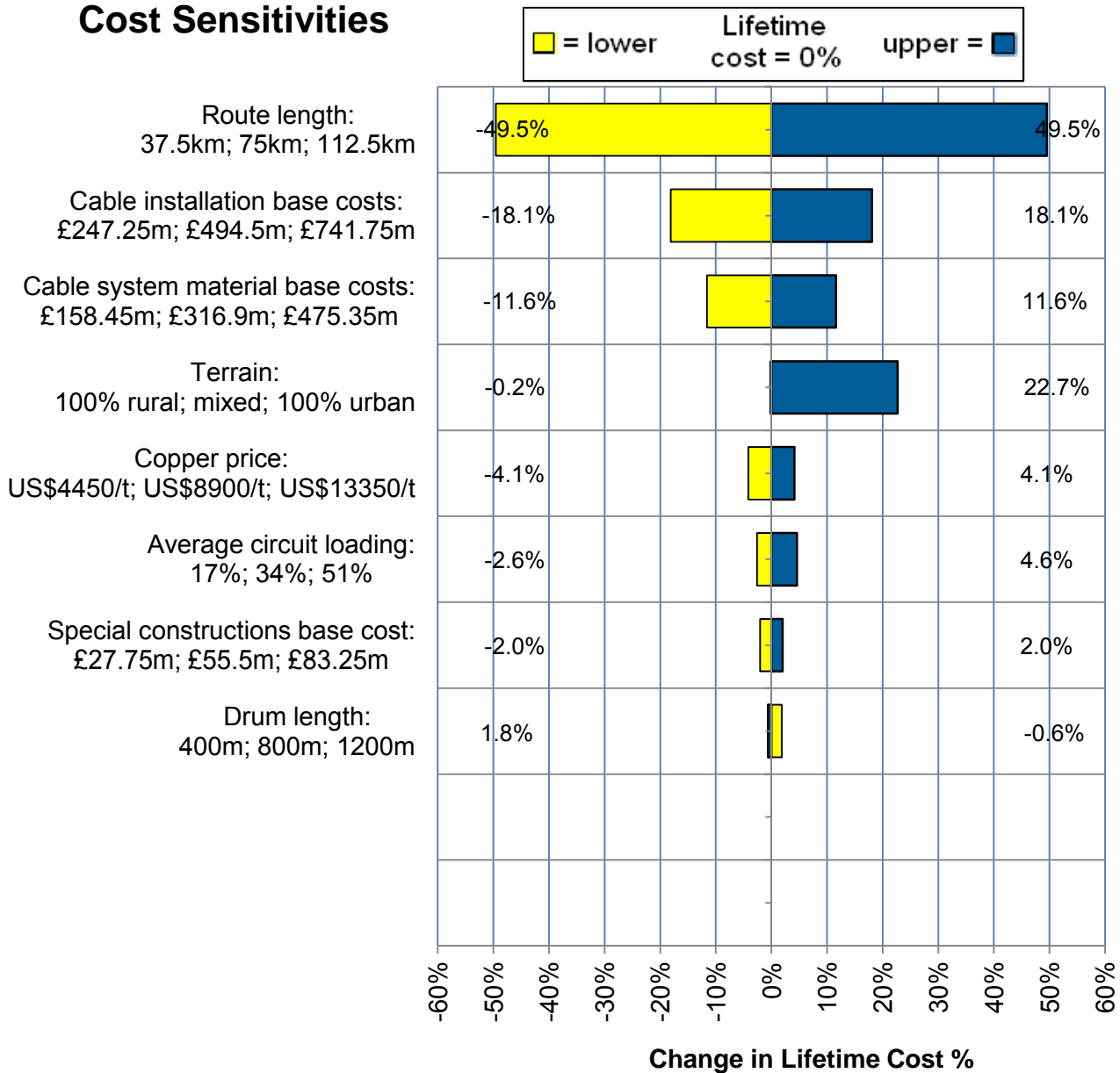

Underground
cable

Lifetime Cost Results (£18.9m/km; £2960/MVA-km)

| | |
|----------------------------------|-----------------|
| Fixed Build Cost | £8.8m |
| Variable Build Cost | £1243.9m |
| Build Cost Total for 75km | £1252.7m |
| plus Variable Operating Cost | £161.6m |
| Lifetime Cost for 75km | £1414.3m |

| | |
|---|------------------|
| Lifetime Cost for 75km divided by route length ÷ 75km | £1414.3m |
| Lifetime Cost per km | £18.9m/km |

| | |
|---|---------------------|
| Lifetime Cost per km divided by Power Transfer ÷ 6380 MVA | £18.9m/km |
| Lifetime PTC* per km | £2960/MVA-km |

Other Results

Losses = 10% of Lifetime Cost for 75km

Costs most sensitive to:

- Route length:
-49.5% to 49.5%
- Cable installation base costs:
-18.1% to 18.1%

Notes (Jan-12)

* PTC = Power Transfer Cost

AC Underground Cable (direct-buried)

75km Route Lifetime Cost: £1527.8m

Hi capacity (6930 MVA); 400 kV AC

Fixed Build Costs (£8.8m)

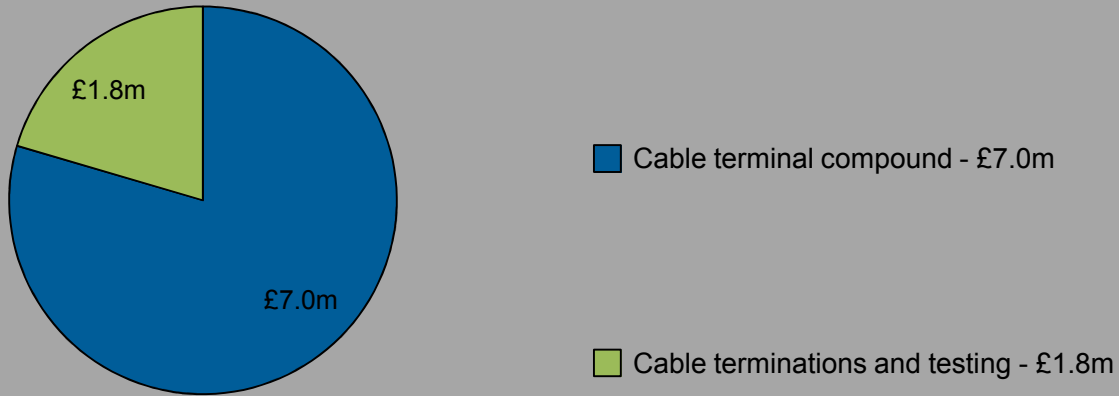

Variable Build Costs (£1351.6m)

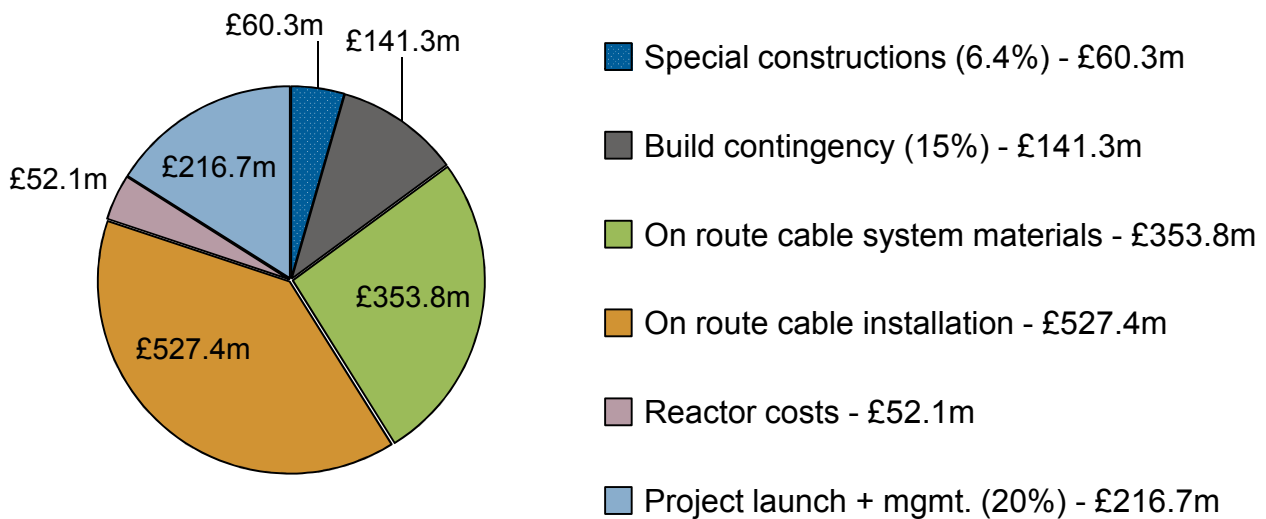

Variable Operating Costs (£167.4m)

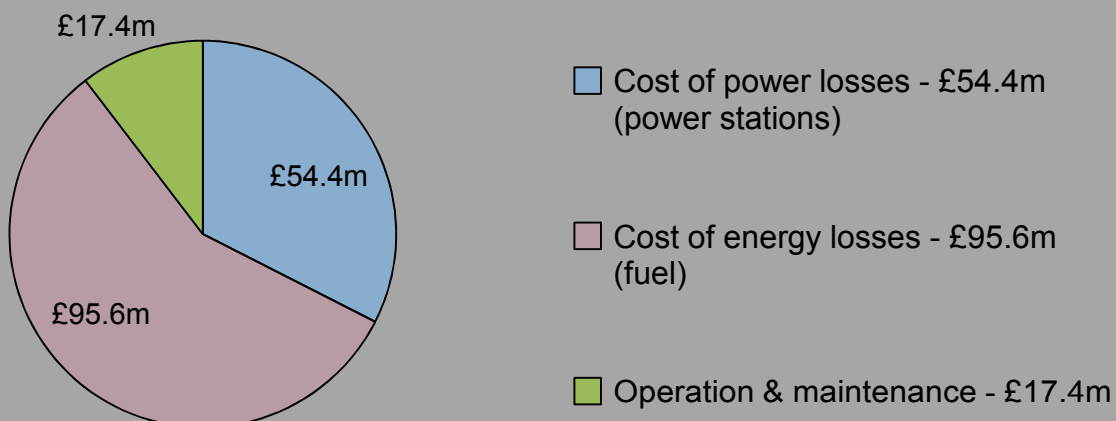

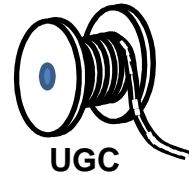

Cost Sensitivities

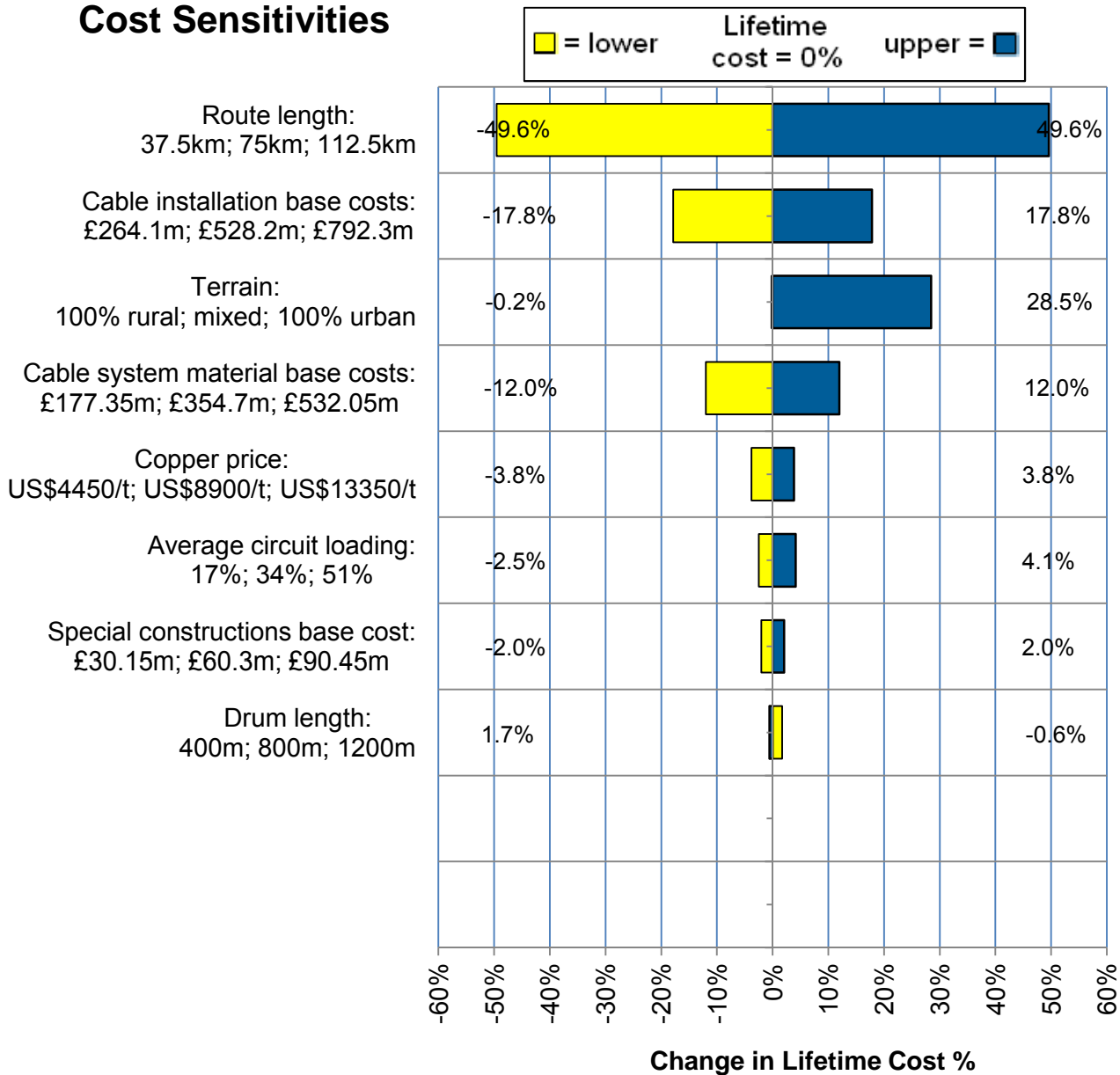

Underground cable

Lifetime Cost Results (£20.4m/km; £2940/MVA-km)

| | |
|---|-------------------------|
| Fixed Build Cost | £8.8m |
| Variable Build Cost | £1351.6m |
| Build Cost Total for 75km | £1360.4m |
| plus Variable Operating Cost | £167.4m |
| Lifetime Cost for 75km | £1527.8m |
| ↓ | |
| Lifetime Cost for 75km divided by route length ÷ 75km | £1527.8m ÷ 75km |
| Lifetime Cost per km | £20.4m/km |
| ↓ | |
| Lifetime Cost per km divided by Power Transfer ÷ 6930 MVA | £20.4m/km ÷ 6930 MVA |
| Lifetime PTC* per km | £2940/MVA-km |

| |
|---|
| Other Results |
| Losses = 10% of Lifetime Cost for 75km |
| Costs most sensitive to: |
| <ul style="list-style-type: none"> Route length: -49.6% to 49.6% Cable installation base costs: -17.8% to 17.8% |

| |
|-----------------------------|
| Notes (Jan-12) |
| * PTC = Power Transfer Cost |

AC Underground Cable (tunnel)

3km Route Lifetime Cost: £101.9m

Lo capacity (3190 MVA); 400 kV AC

Fixed Build Costs (£50.2m)

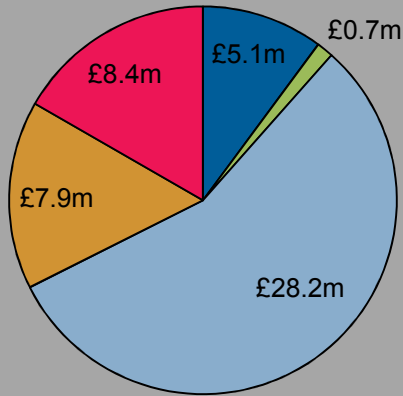

- Cable terminal compound - £5.1m
- Cable terminations and testing - £0.7m
- Tunnel + shaft - £28.2m
- Tunnel boring machine costs - £7.9m
- Tunnel PM + overheads - £8.4m

Variable Build Costs (£48.4m)

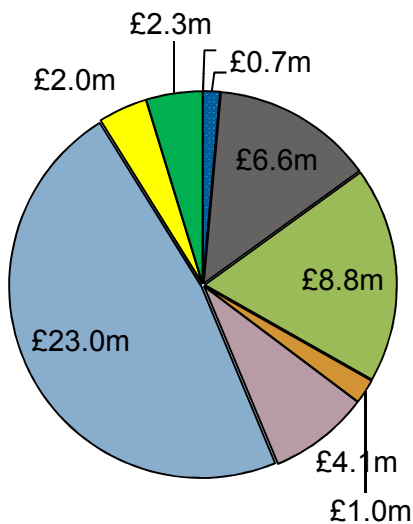

- Cable build contingency (3%) - £0.7m
- On route cable system materials - £6.6m
- On route cable installation - £8.8m
- Reactor costs - £1.0m
- Project launch + mgmt. (18%) - £4.1m
- Tunnel + shaft - £23.0m
- Tunnel boring machine costs - £2.0m
- Tunnel PM + overheads - £2.3m

Variable Operating Costs (£3.3m)

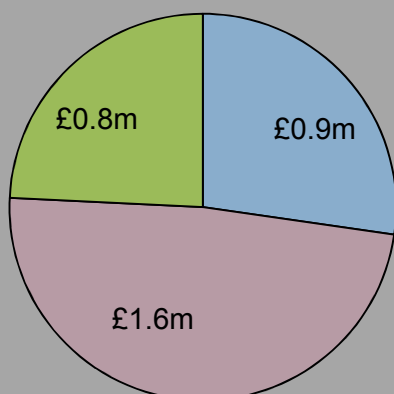

- Cost of power losses - £0.9m (power stations)
- Cost of energy losses - £1.6m (fuel)
- Operation & maintenance - £0.8m

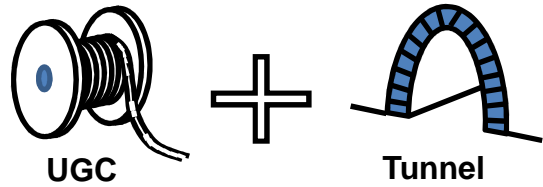

Cost Sensitivities

= lower
 Lifetime cost = 0%
 upper =

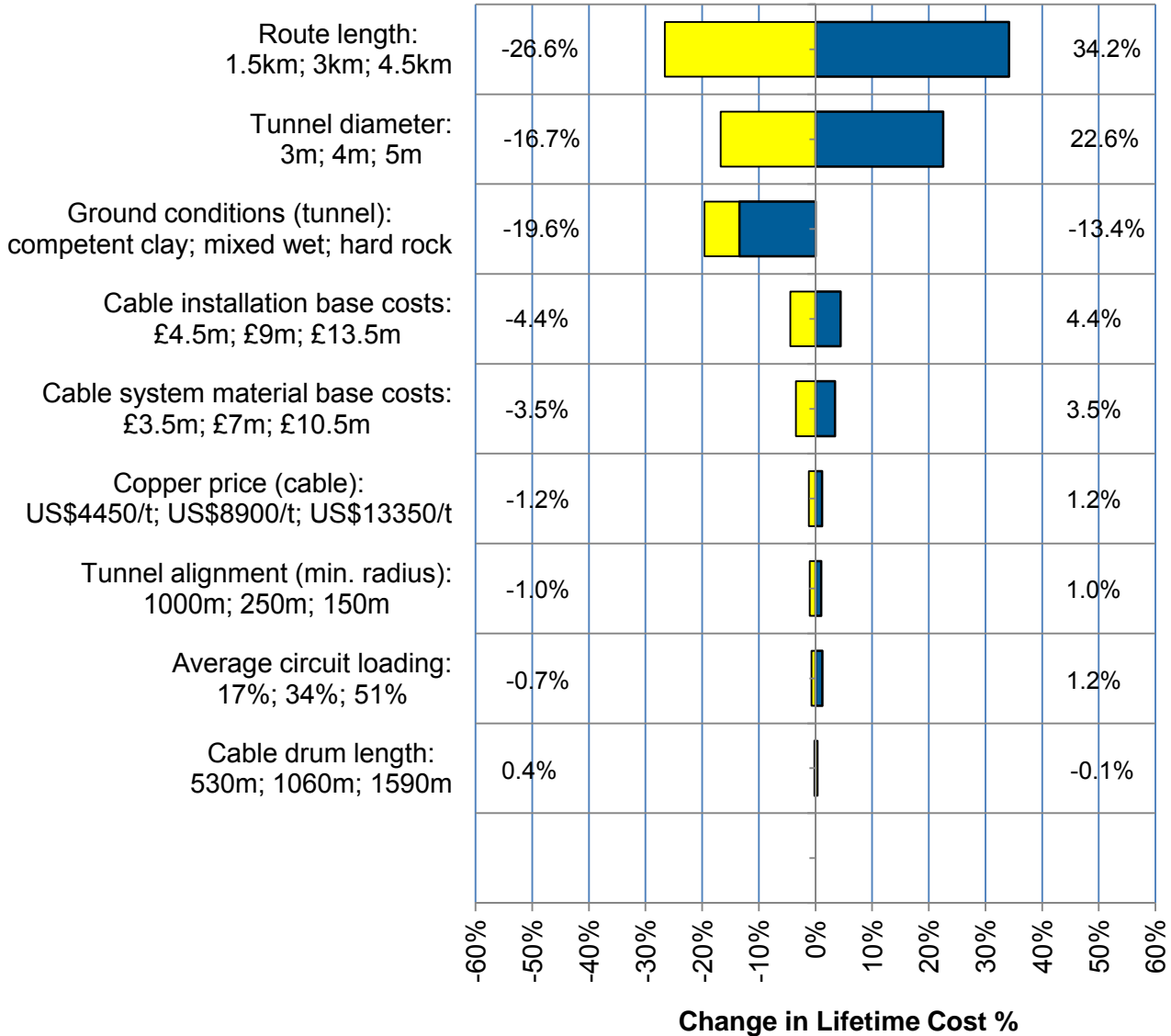

Underground cable

Lifetime Cost Results (£34.0m/km; £10650/MVA-km)

| | |
|---|----------------------|
| Fixed Build Cost | £50.2m |
| Variable Build Cost | £48.4m |
| Build Cost Total for 3km | £98.6m |
| plus Variable Operating Cost | £3.3m |
| Lifetime Cost for 3km | £101.9m |
| ↓ | |
| Lifetime Cost for 3km divided by route length ÷ 3km | £101.9m ÷ 3km |
| Lifetime Cost per km | £34.0m/km |
| ↓ | |
| Lifetime Cost per km divided by Power Transfer ÷ 3190 MVA | £34.0m/km ÷ 3190 MVA |
| Lifetime PTC* per km | £10650/MVA-km |

| |
|---|
| Other Results |
| Losses = 2% of Lifetime Cost for 3km |
| Costs most sensitive to: |
| <ul style="list-style-type: none"> Route length: -26.6% to 34.2% Tunnel diameter: -16.7% to 22.6% |

| |
|-----------------------------|
| Notes (Jan-12) |
| * PTC = Power Transfer Cost |

Tunnel

AC Underground Cable (tunnel)

3km Route Lifetime Cost: £126.9m

Med capacity (6380 MVA); 400 kV AC

Fixed Build Costs (£52.9m)

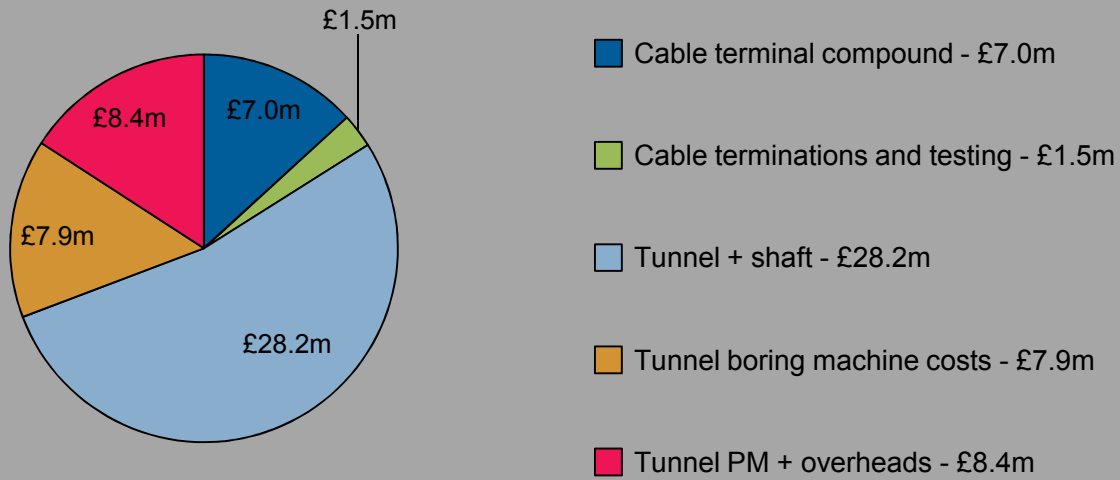

Variable Build Costs (£67.6m)

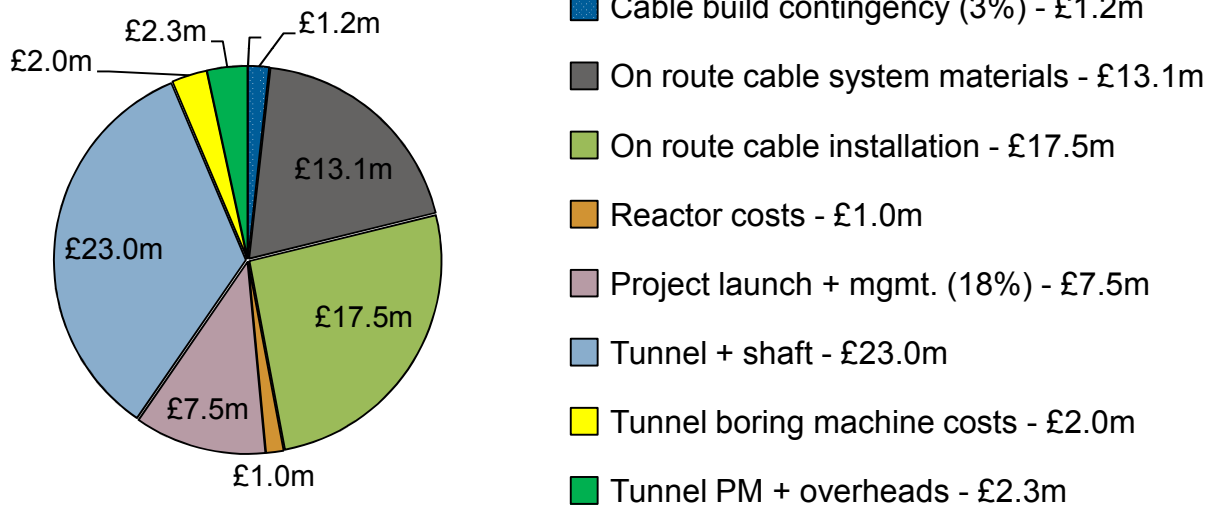

Variable Operating Costs (£6.4m)

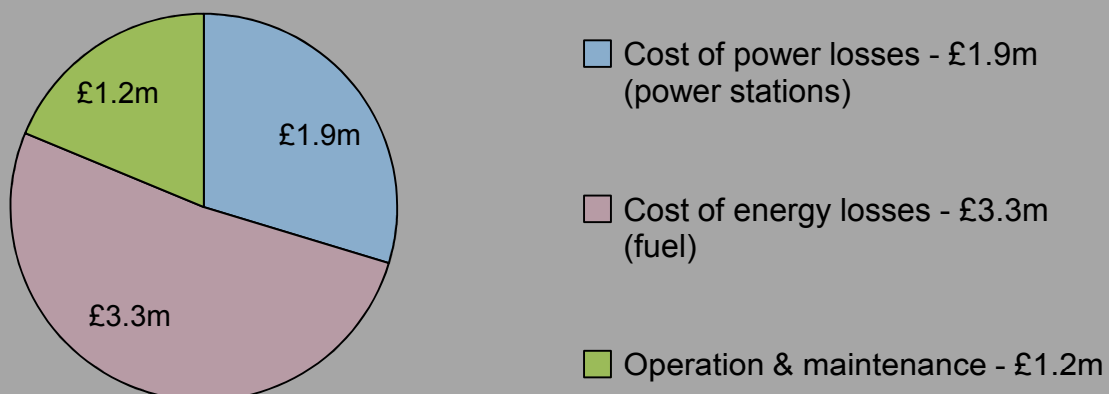

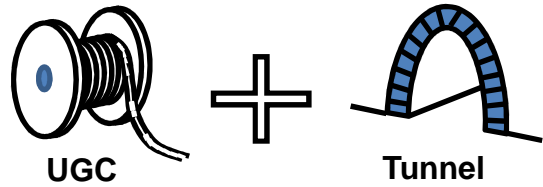

Cost Sensitivities

Legend: ■ = lower, Lifetime cost = 0%, ■ = upper

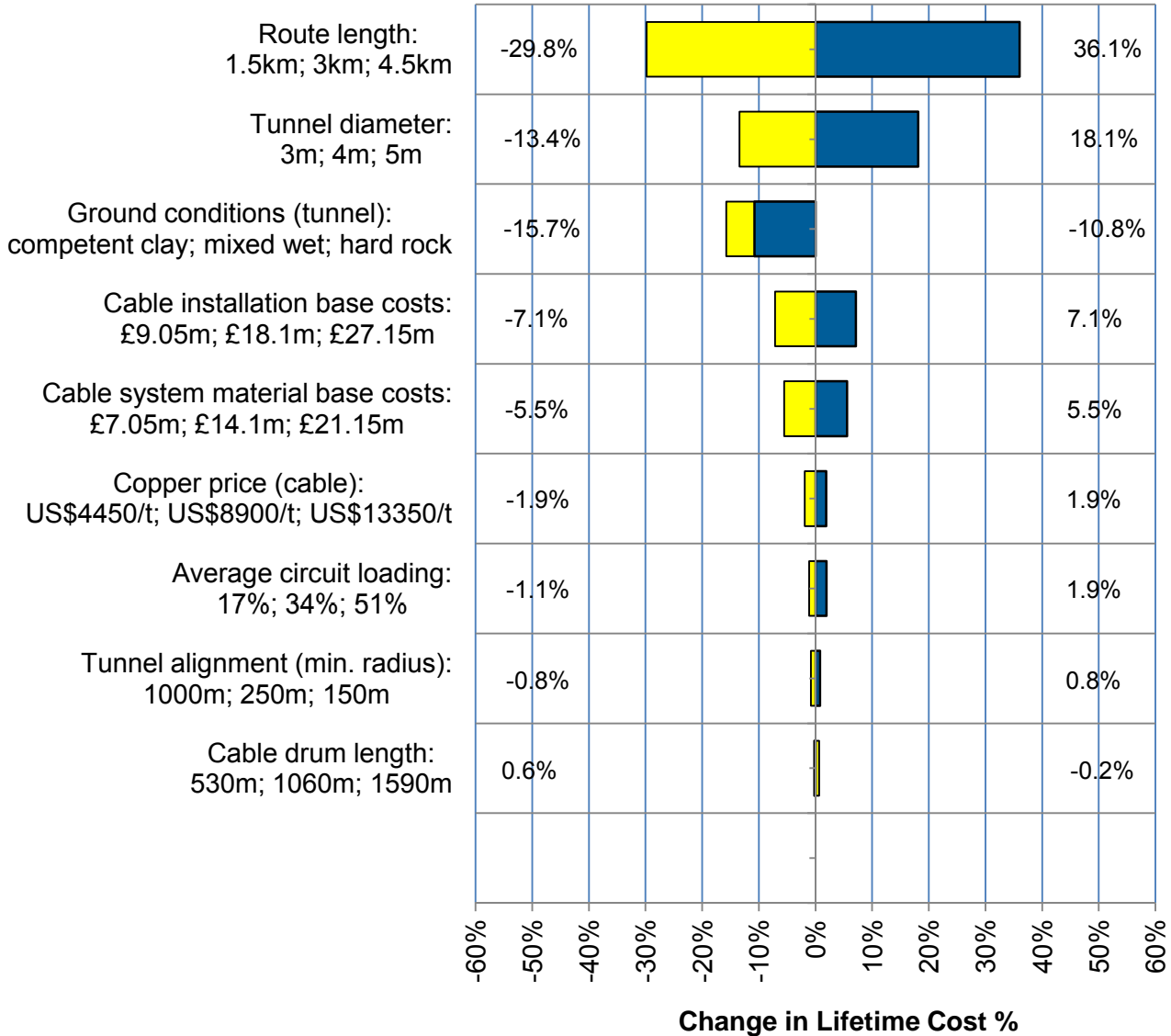

Underground cable

Lifetime Cost Results (£42.3m/km; £6630/MVA-km)

| | |
|---|---------------------|
| Fixed Build Cost | £52.9m |
| Variable Build Cost | £67.6m |
| Build Cost Total for 3km | £120.5m |
| plus Variable Operating Cost | £6.4m |
| Lifetime Cost for 3km | £126.9m |
| ↓ | |
| Lifetime Cost for 3km divided by route length ÷ 3km | £126.9m |
| Lifetime Cost per km | £42.3m/km |
| ↓ | |
| Lifetime Cost per km divided by Power Transfer ÷ 6380 MVA | £42.3m/km |
| Lifetime PTC* per km | £6630/MVA-km |

| |
|---------------------------------------|
| Other Results |
| Losses = 4% of Lifetime Cost for 3km |
| Costs most sensitive to: |
| • Route length: -29.8% to 36.1% |
| • Tunnel diameter: -13.4% to 18.1% |

| |
|-----------------------------|
| Notes (Jan-12) |
| * PTC = Power Transfer Cost |

Tunnel

AC Underground Cable (tunnel)

3km Route Lifetime Cost: £129.1m

Hi capacity (6930 MVA); 400 kV AC

Fixed Build Costs (£52.9m)

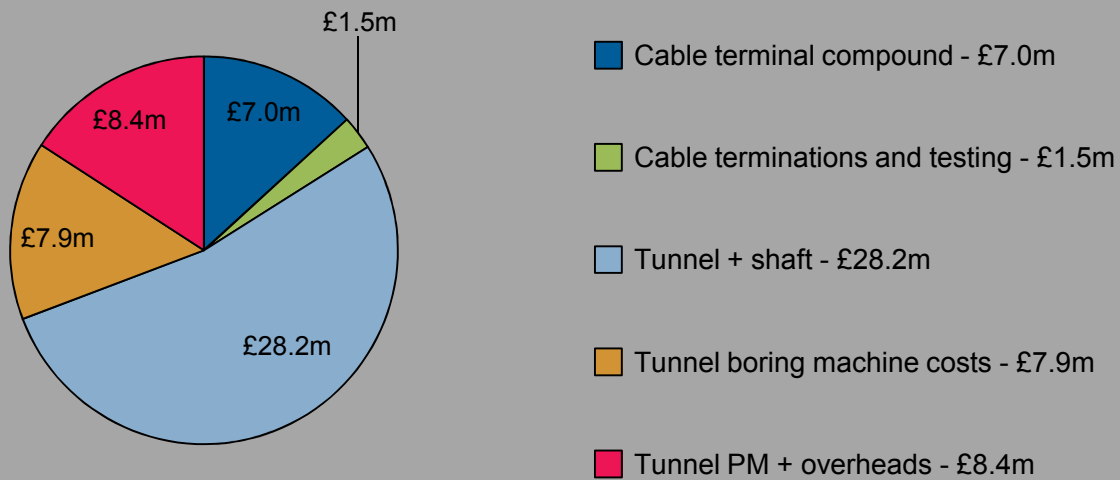

Variable Build Costs (£69.5m)

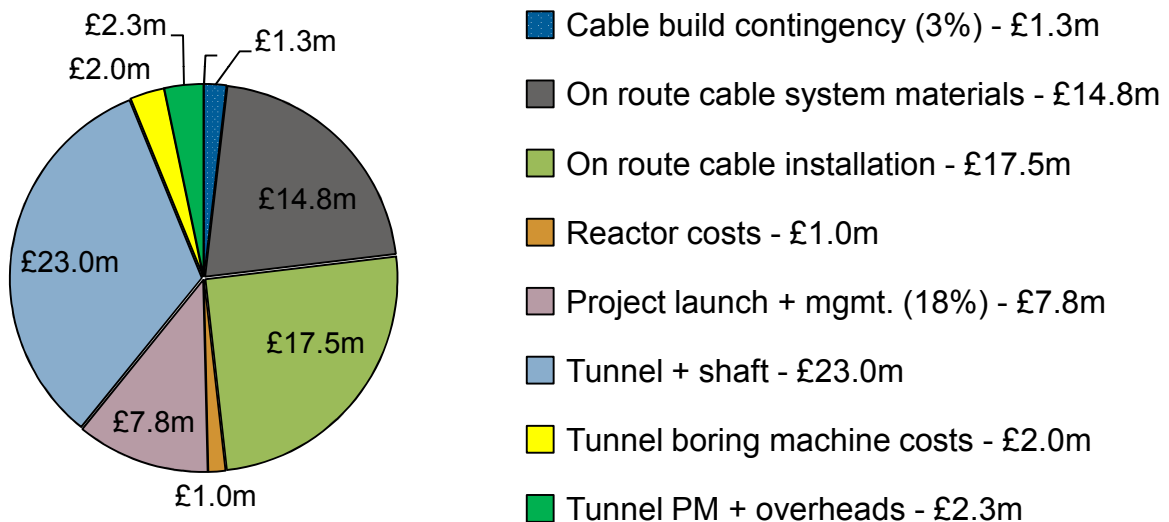

Variable Operating Costs (£6.6m)

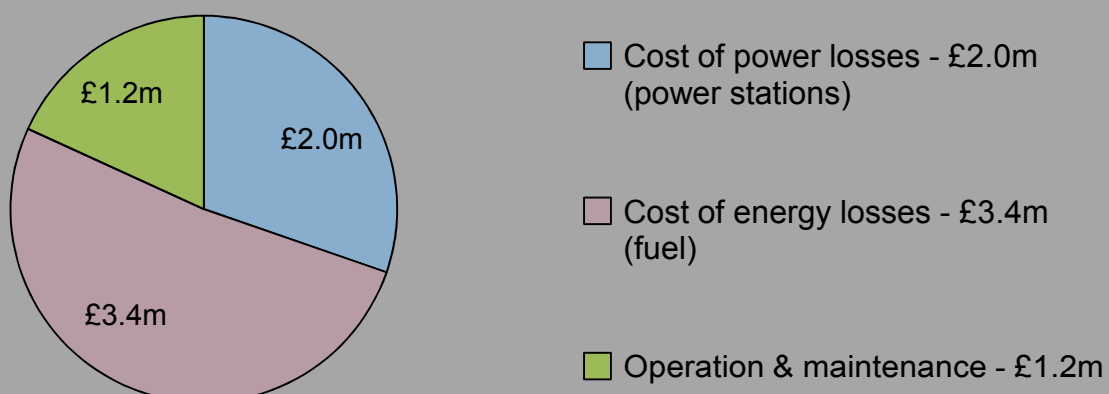

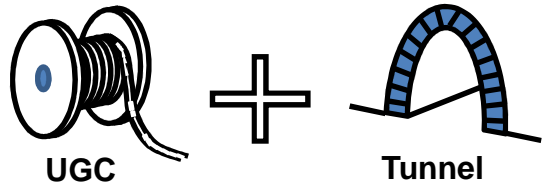

Cost Sensitivities

= lower
 Lifetime cost = 0%
 upper =

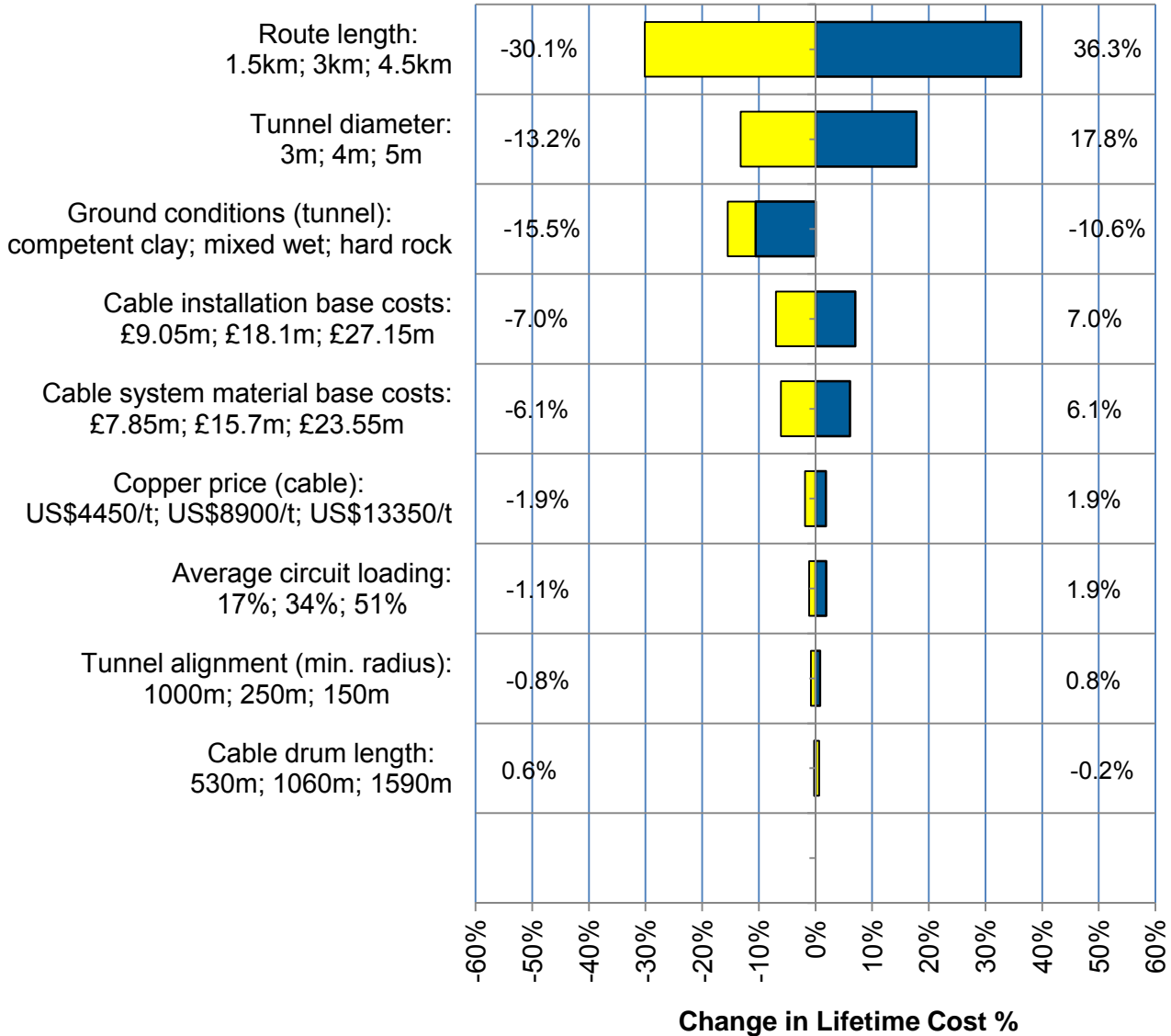

Underground cable

Lifetime Cost Results (£43.0m/km; £6210/MVA-km)

| | |
|---|----------------------|
| Fixed Build Cost | £52.9m |
| Variable Build Cost | £69.5m |
| Build Cost Total for 3km | £122.4m |
| plus Variable Operating Cost | £6.6m |
| Lifetime Cost for 3km | £129.1m |
| ↓ | |
| Lifetime Cost for 3km divided by route length ÷ 3km | £129.1m ÷ 3km |
| Lifetime Cost per km | £43.0m/km |
| ↓ | |
| Lifetime Cost per km divided by Power Transfer ÷ 6930 MVA | £43.0m/km ÷ 6930 MVA |
| Lifetime PTC* per km | £6210/MVA-km |

| |
|---|
| Other Results |
| Losses = 4% of Lifetime Cost for 3km |
| Costs most sensitive to: |
| <ul style="list-style-type: none"> Route length: -30.1% to 36.3% Tunnel diameter: -13.2% to 17.8% |

| |
|-----------------------------|
| Notes (Jan-12) |
| * PTC = Power Transfer Cost |

Tunnel

AC Underground Cable (tunnel)

15km Route Lifetime Cost: £336.9m

Lo capacity (3190 MVA); 400 kV AC

Fixed Build Costs (£97.5m)

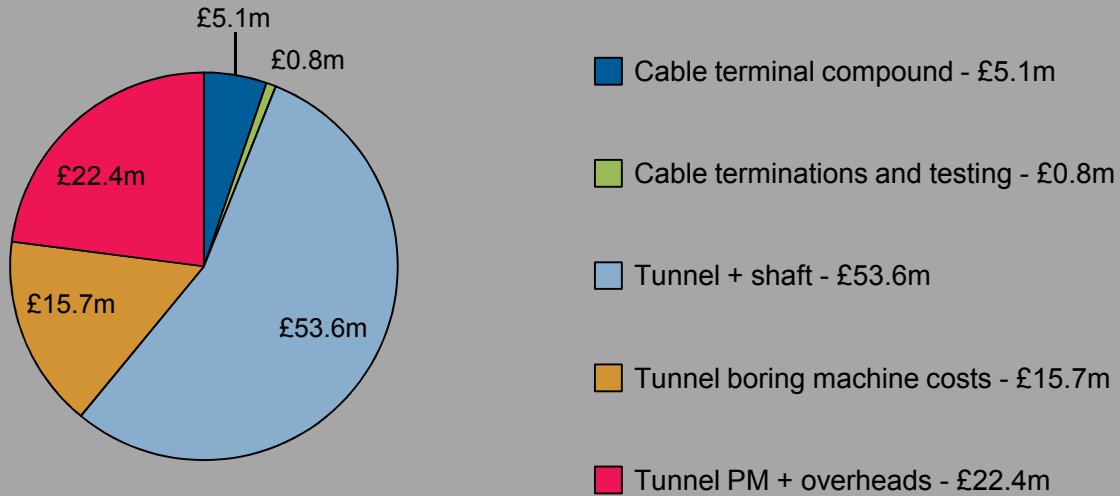

Variable Build Costs (£222.6m)

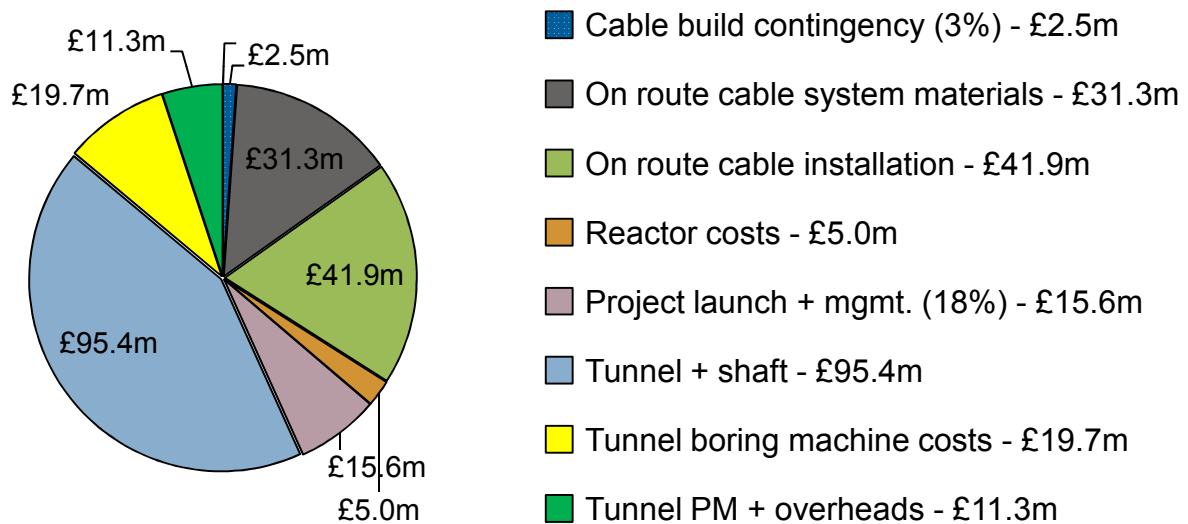

Variable Operating Costs (£16.8m)

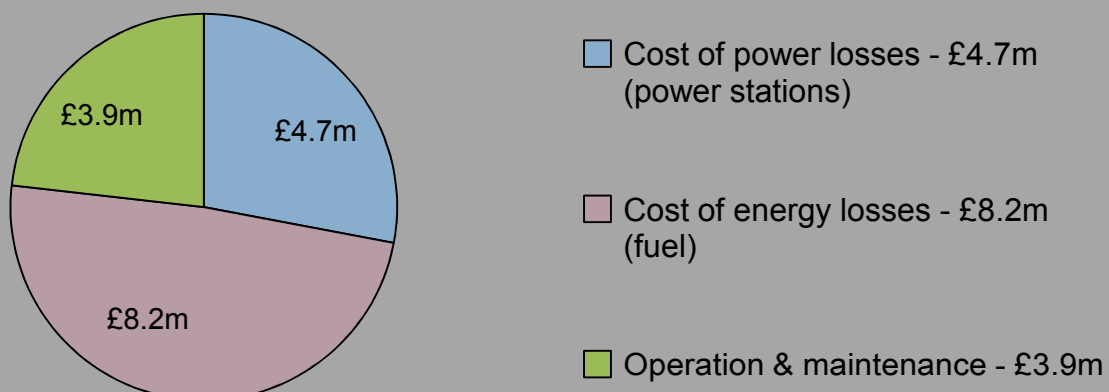

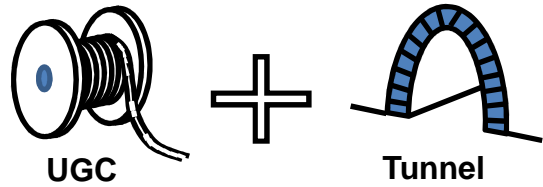

Cost Sensitivities

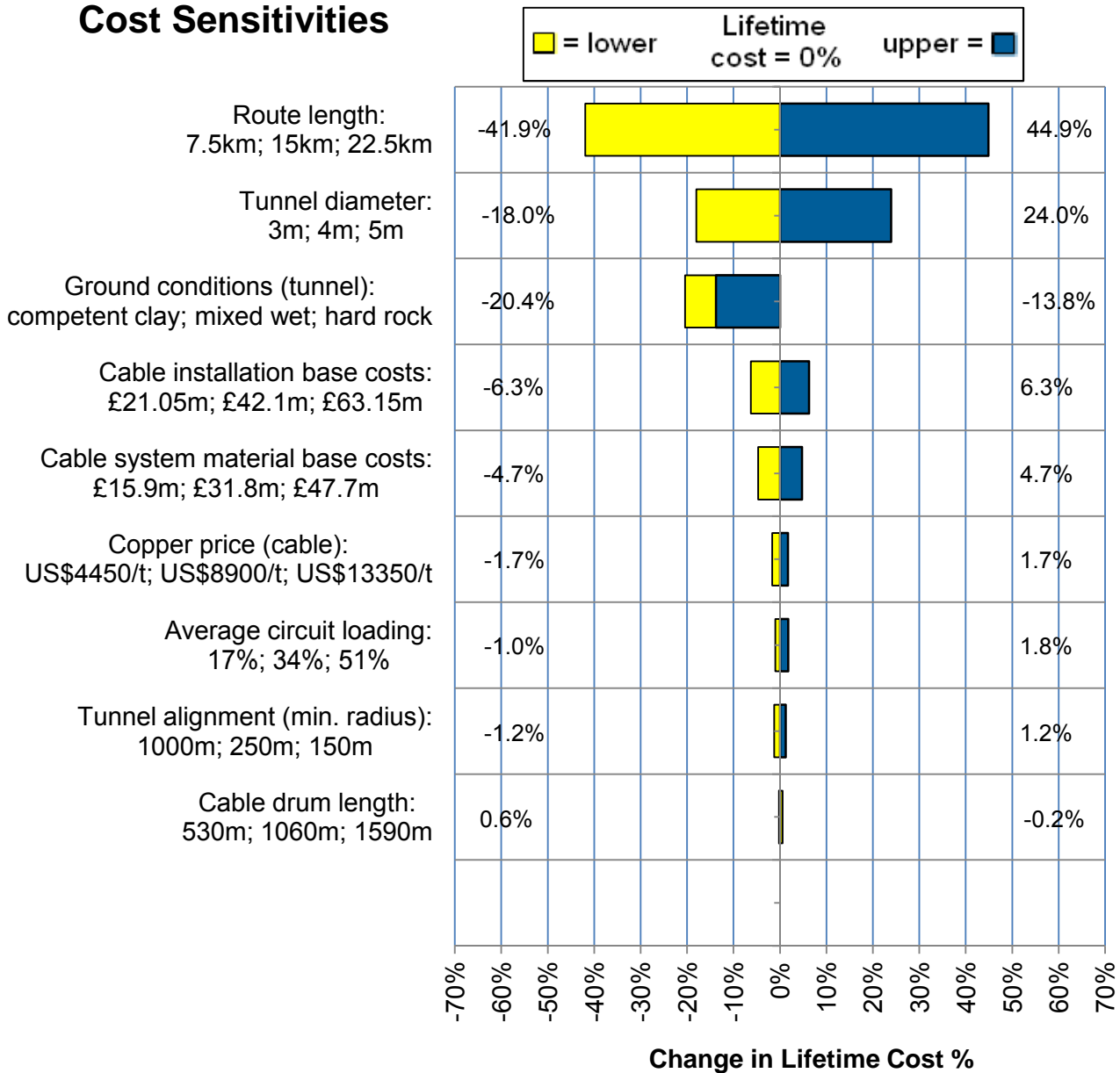

Underground cable

Lifetime Cost Results (£22.5m/km; £7040/MVA-km)

| | |
|----------------------------------|----------------|
| Fixed Build Cost | £97.5m |
| Variable Build Cost | £222.6m |
| Build Cost Total for 15km | £320.1m |
| plus Variable Operating Cost | £16.8m |
| Lifetime Cost for 15km | £336.9m |

| | |
|--|------------------|
| Lifetime Cost for 15km divided by route length | £336.9m ÷ 15km |
| Lifetime Cost per km | £22.5m/km |

| | |
|--|----------------------|
| Lifetime Cost per km divided by Power Transfer | £22.5m/km ÷ 3190 MVA |
| Lifetime PTC* per km | £7040/MVA-km |

Other Results

Losses = 4% of Lifetime Cost for 15km

Costs most sensitive to:

- Route length: -41.9% to 44.9%
- Tunnel diameter: -18% to 24%

Notes (Jan-12)

* PTC = Power Transfer Cost

Tunnel

AC Underground Cable (tunnel)

15km Route Lifetime Cost: £444.2m

Med capacity (6380 MVA); 400 kV AC

Fixed Build Costs (£100.2m)

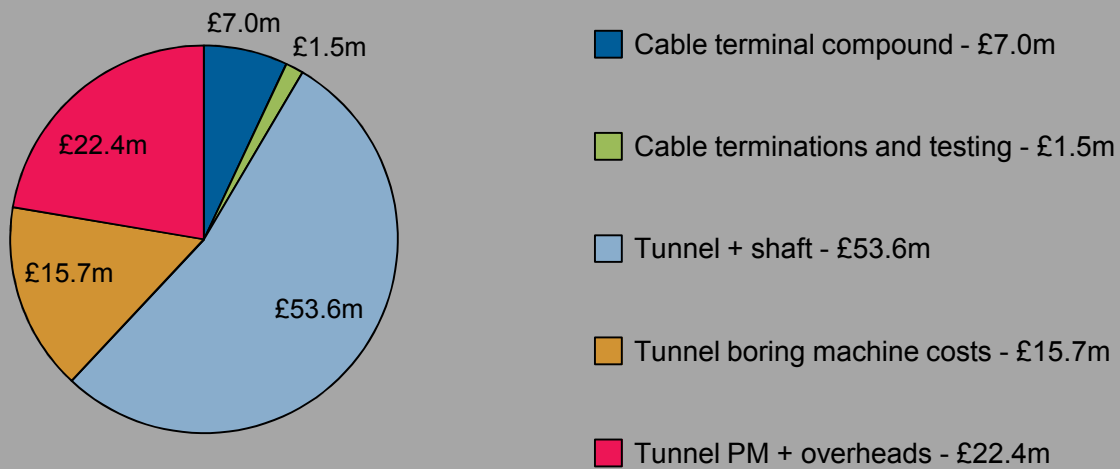

Variable Build Costs (£312.2m)

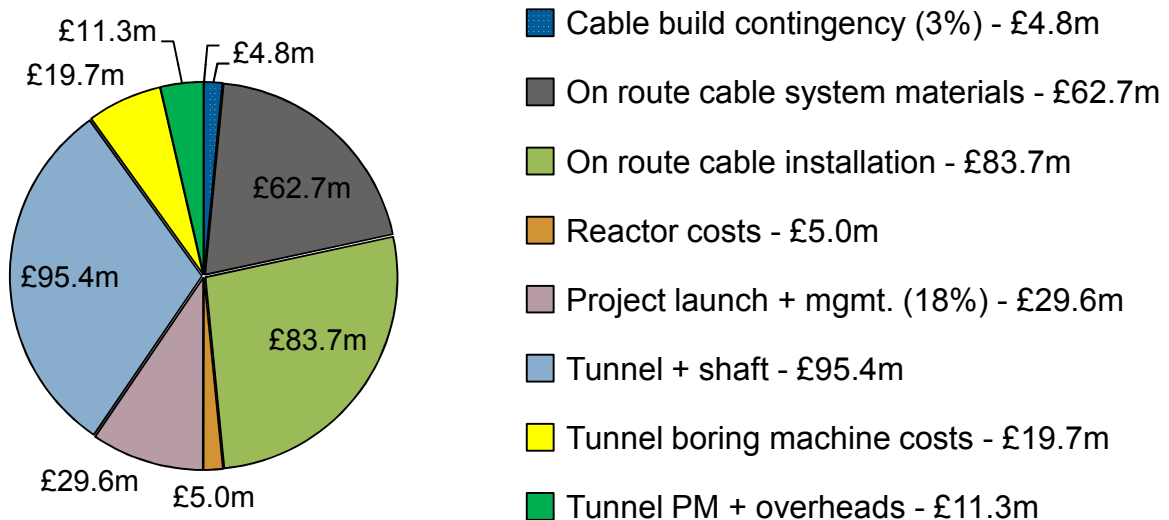

Variable Operating Costs (£31.9m)

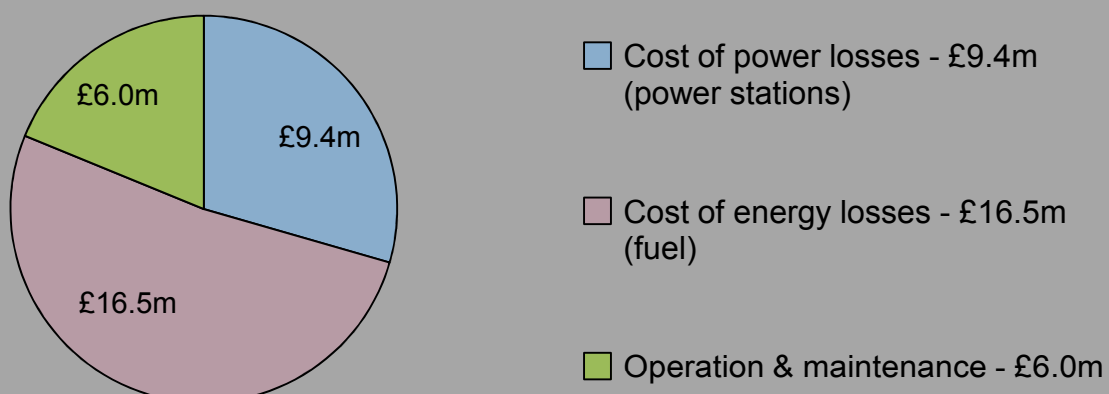

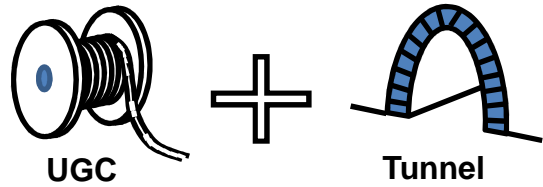

Cost Sensitivities

= lower
 Lifetime cost = 0%
 upper =

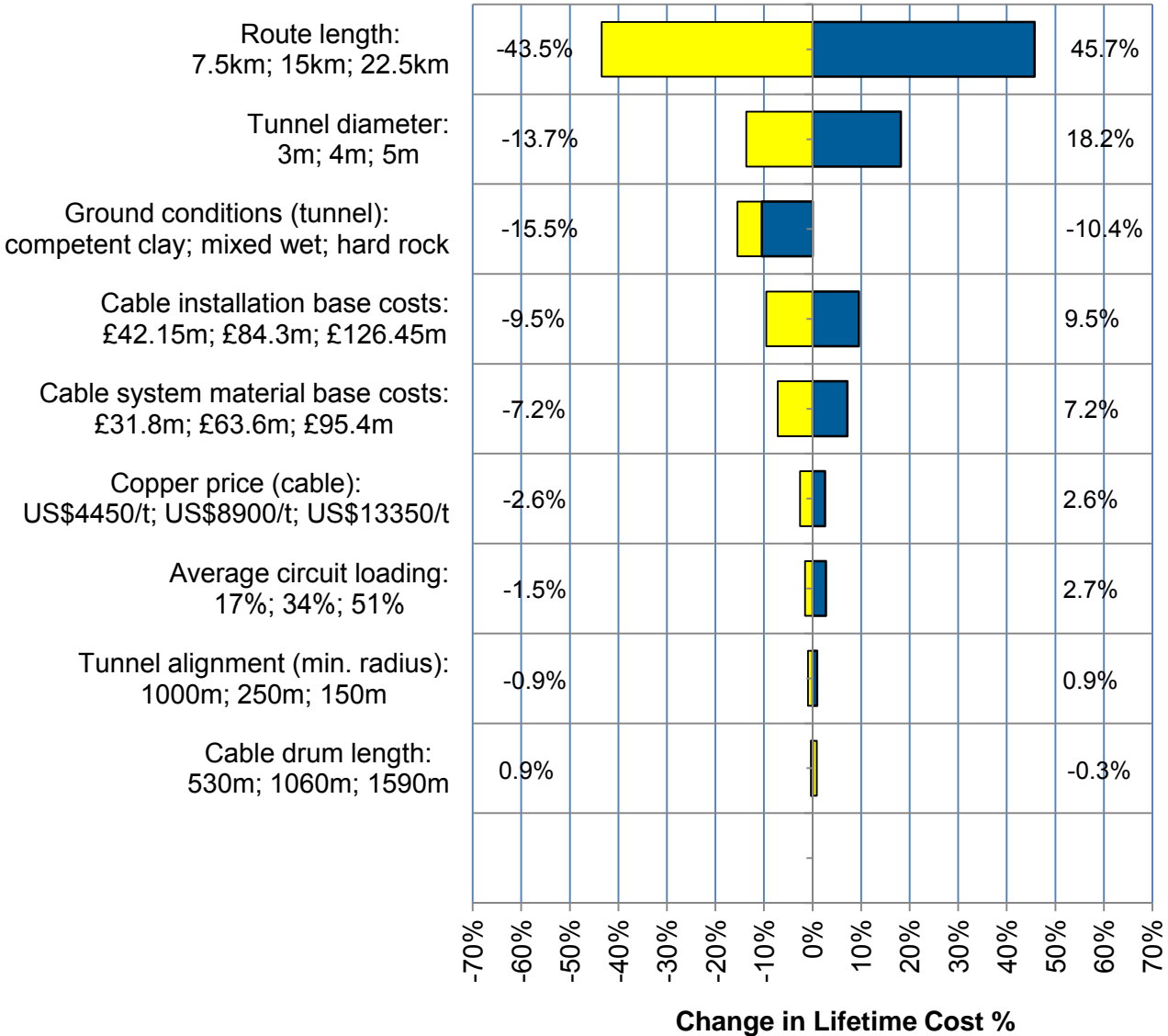

Underground cable

Lifetime Cost Results (£29.6m/km; £4640/MVA-km)

| | |
|--|----------------------|
| Fixed Build Cost | £100.2m |
| Variable Build Cost | £312.2m |
| Build Cost Total for 15km | £412.4m |
| plus Variable Operating Cost | £31.9m |
| Lifetime Cost for 15km | £444.2m |
| ↓ | |
| Lifetime Cost for 15km divided by route length | £444.2m ÷ 15km |
| Lifetime Cost per km | £29.6m/km |
| ↓ | |
| Lifetime Cost per km divided by Power Transfer | £29.6m/km ÷ 6380 MVA |
| Lifetime PTC* per km | £4640/MVA-km |

Other Results
Losses = 6% of Lifetime Cost for 15km

Costs most sensitive to:

- Route length: -43.5% to 45.7%
- Tunnel diameter: -13.7% to 18.2%

Notes (Jan-12)

* PTC = Power Transfer Cost

Tunnel

AC Underground Cable (tunnel)

15km Route Lifetime Cost: £454.7m

Hi capacity (6930 MVA); 400 kV AC

Fixed Build Costs (£100.2m)

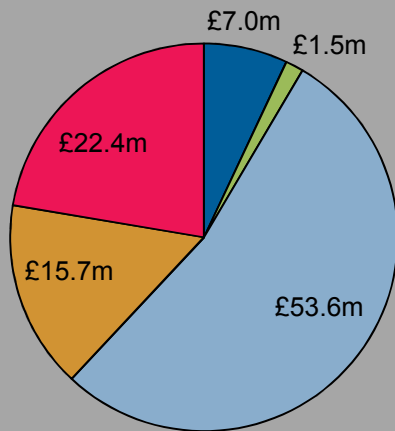

- Cable terminal compound - £7.0m
- Cable terminations and testing - £1.5m
- Tunnel + shaft - £53.6m
- Tunnel boring machine costs - £15.7m
- Tunnel PM + overheads - £22.4m

Variable Build Costs (£321.5m)

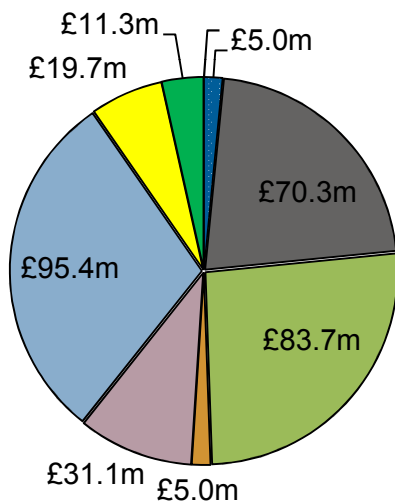

- Cable build contingency (3%) - £5.0m
- On route cable system materials - £70.3m
- On route cable installation - £83.7m
- Reactor costs - £5.0m
- Project launch + mgmt. (18%) - £31.1m
- Tunnel + shaft - £95.4m
- Tunnel boring machine costs - £19.7m
- Tunnel PM + overheads - £11.3m

Variable Operating Costs (£33.0m)

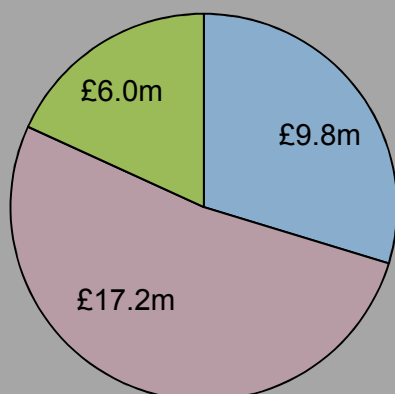

- Cost of power losses - £9.8m (power stations)
- Cost of energy losses - £17.2m (fuel)
- Operation & maintenance - £6.0m

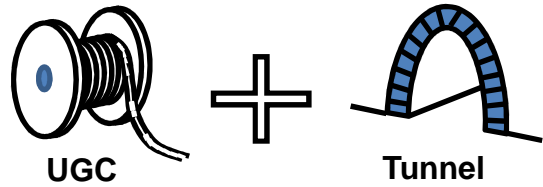

Cost Sensitivities

= lower
 Lifetime cost = 0%
 upper =

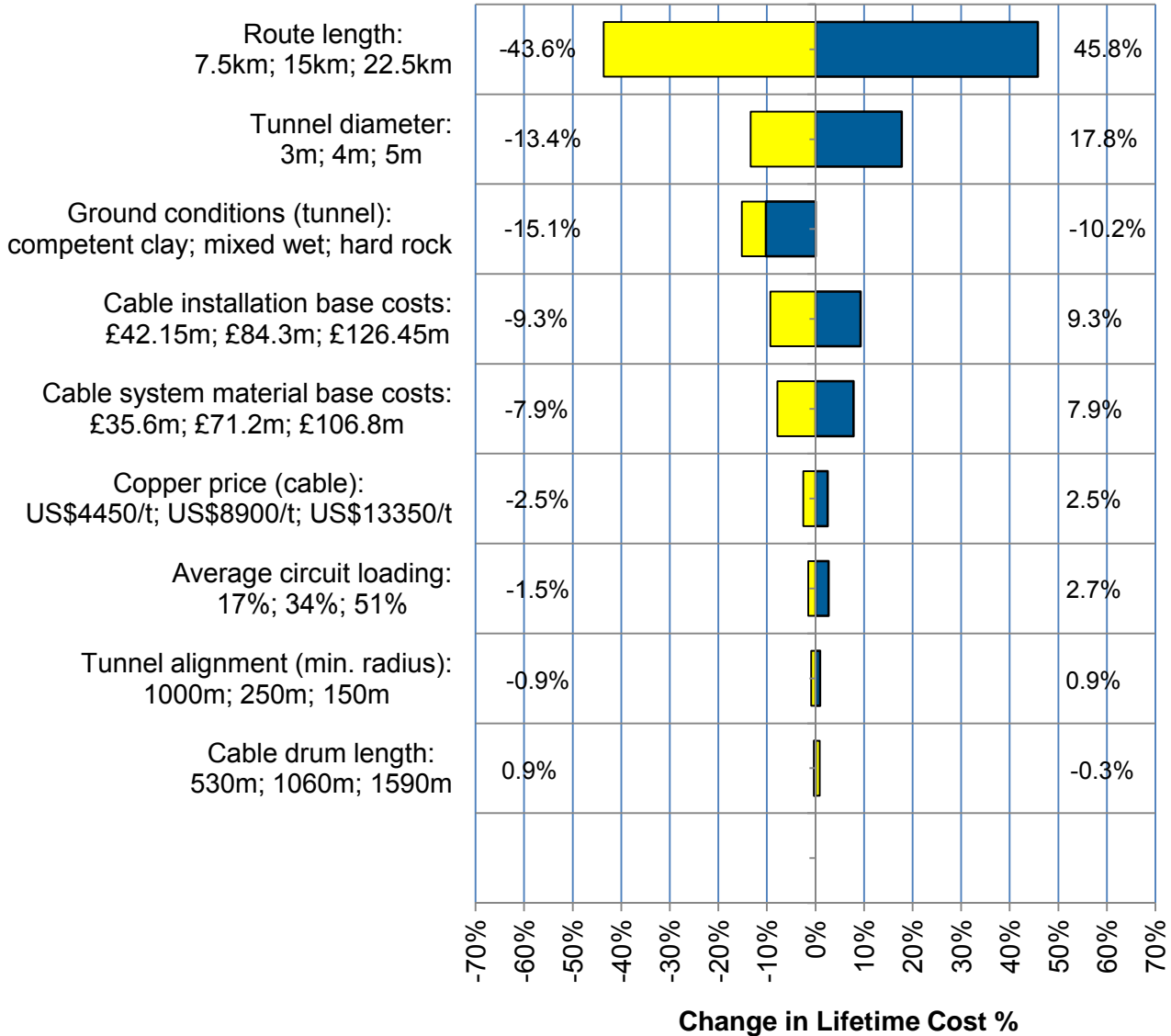

Underground cable

Lifetime Cost Results (£30.3m/km; £4370/MVA-km)

| | |
|--|----------------------|
| Fixed Build Cost | £100.2m |
| Variable Build Cost | £321.5m |
| Build Cost Total for 15km | £421.7m |
| plus Variable Operating Cost | £33.0m |
| Lifetime Cost for 15km | £454.7m |
| ↓ | |
| Lifetime Cost for 15km divided by route length | £454.7m ÷ 15km |
| Lifetime Cost per km | £30.3m/km |
| ↓ | |
| Lifetime Cost per km divided by Power Transfer | £30.3m/km ÷ 6930 MVA |
| Lifetime PTC* per km | £4370/MVA-km |

Other Results
Losses = 6% of Lifetime Cost for 15km

Costs most sensitive to:

- Route length: -43.6% to 45.8%
- Tunnel diameter: -13.4% to 17.8%

Notes (Jan-12)

* PTC = Power Transfer Cost

Tunnel

AC Underground Cable (tunnel)

75km Route Lifetime Cost: £1533.9m

Lo capacity (3190 MVA); 400 kV AC

Fixed Build Costs (£276.7m)

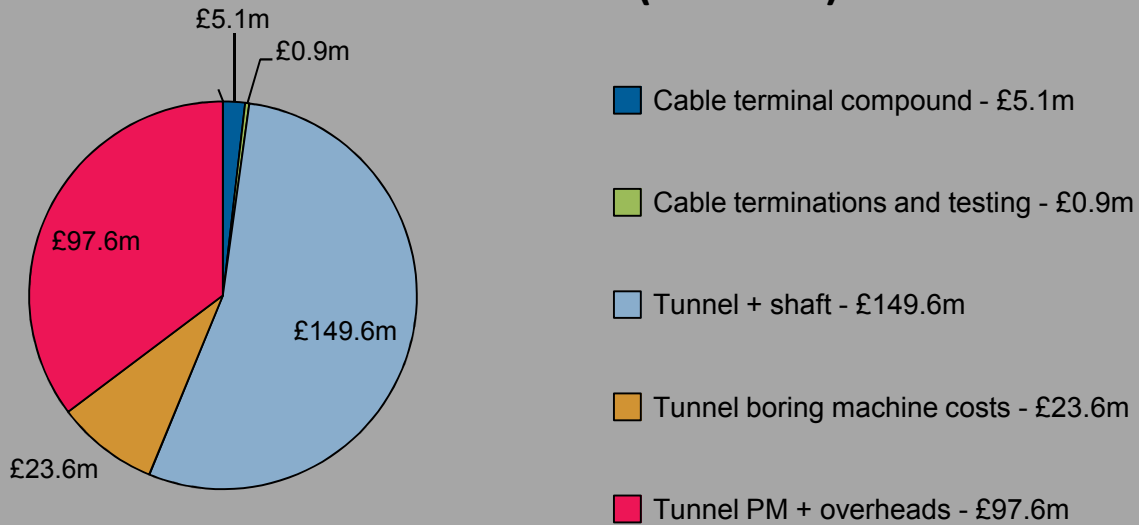

Variable Build Costs (£1165.5m)

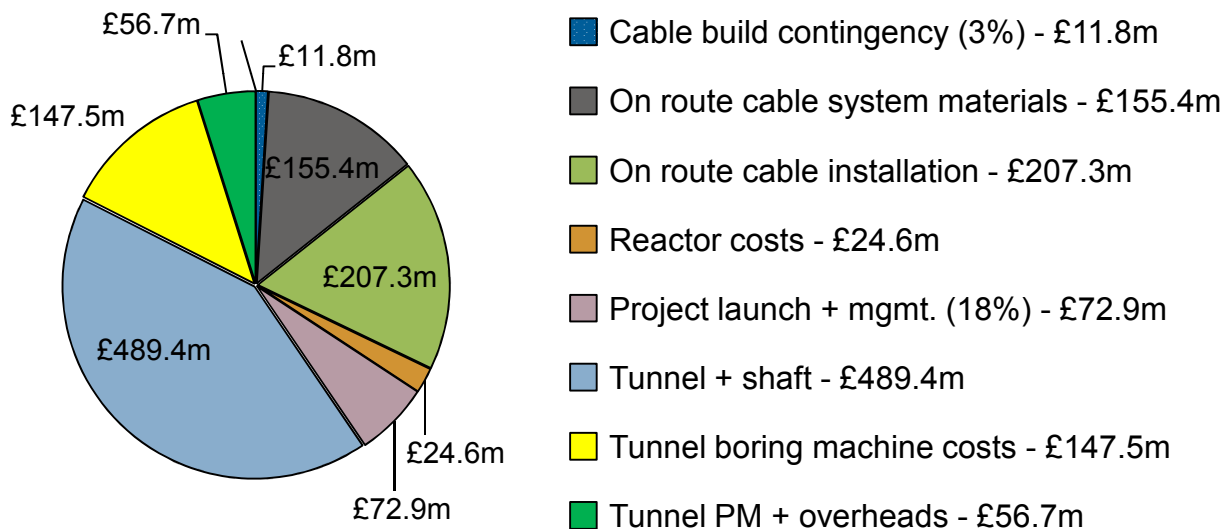

Variable Operating Costs (£91.6m)

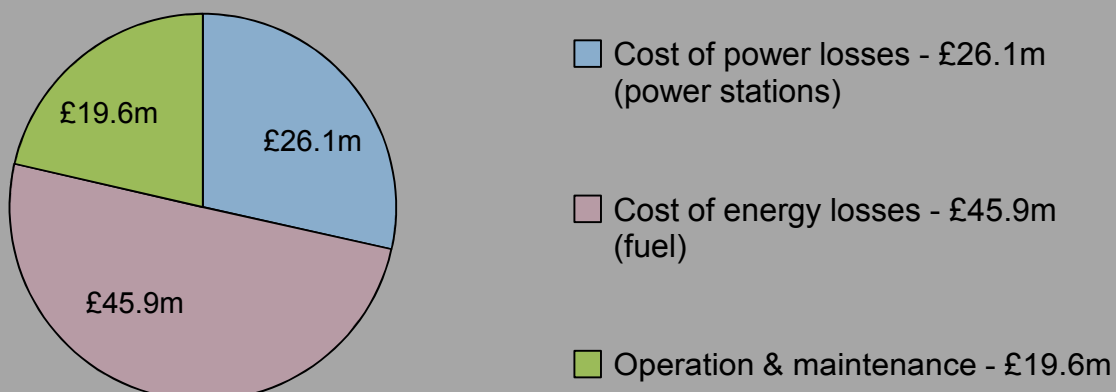

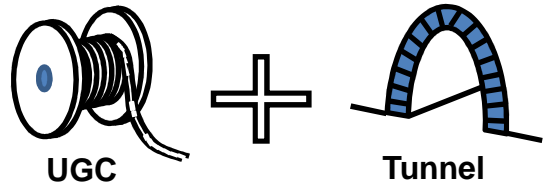

Cost Sensitivities

Legend: ■ = lower, Lifetime cost = 0%, ■ = upper

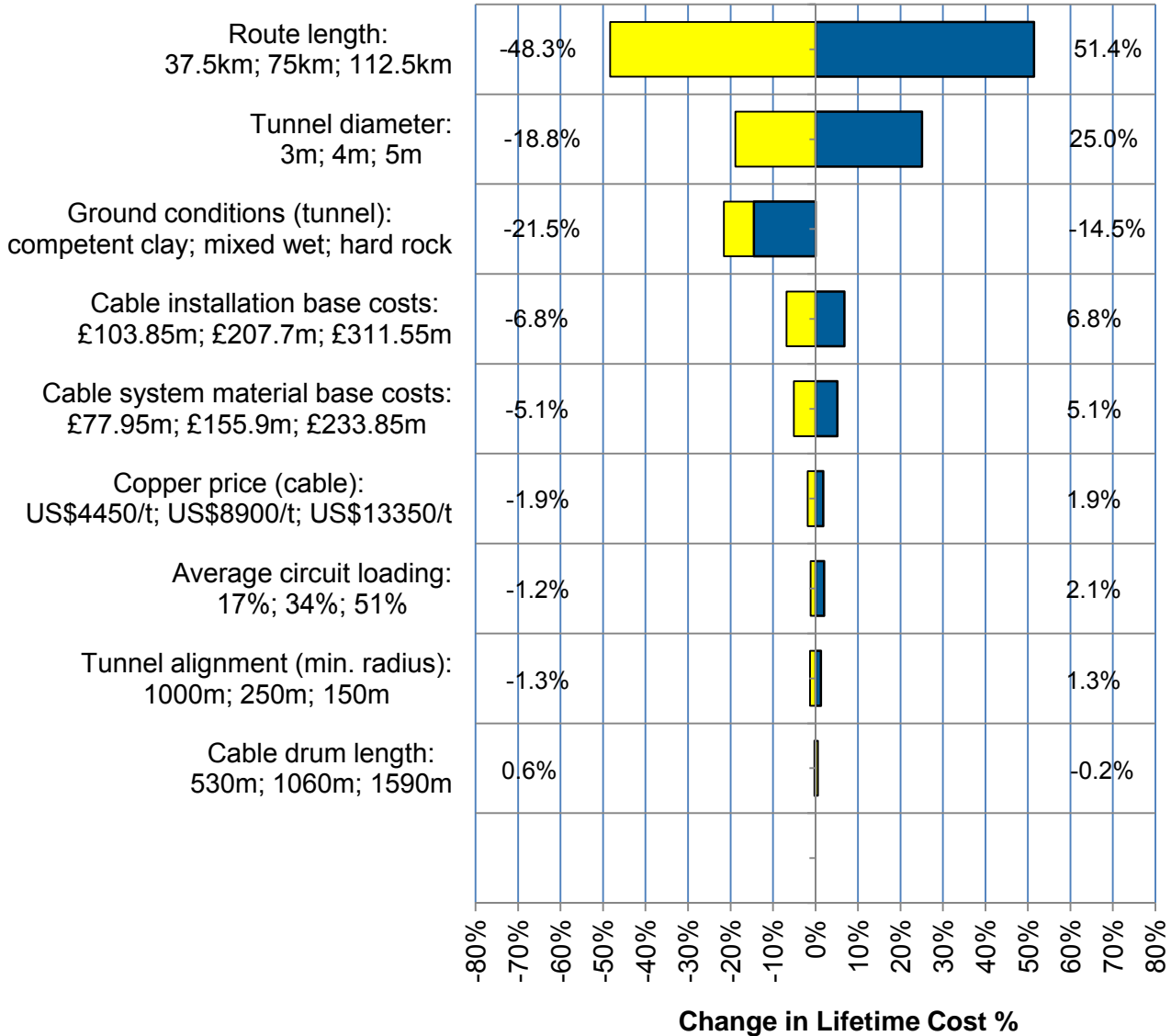

Underground cable

Lifetime Cost Results (£20.5m/km; £6410/MVA-km)

| | |
|--|----------------------|
| Fixed Build Cost | £276.7m |
| Variable Build Cost | £1165.5m |
| Build Cost Total for 75km | £1442.2m |
| plus Variable Operating Cost | £91.6m |
| Lifetime Cost for 75km | £1533.9m |
| ↓ | |
| Lifetime Cost for 75km divided by route length | £1533.9m ÷ 75km |
| Lifetime Cost per km | £20.5m/km |
| ↓ | |
| Lifetime Cost per km divided by Power Transfer | £20.5m/km ÷ 3190 MVA |
| Lifetime PTC* per km | £6410/MVA-km |

Other Results
Losses = 5% of Lifetime Cost for 75km

Costs most sensitive to:

- Route length: -48.3% to 51.4%
- Tunnel diameter: -18.8% to 25%

Notes (Jan-12)

* PTC = Power Transfer Cost

Tunnel

AC Underground Cable (tunnel)

75km Route Lifetime Cost: £2060.5m

Med capacity (6380 MVA); 400 kV AC

Fixed Build Costs (£279.6m)

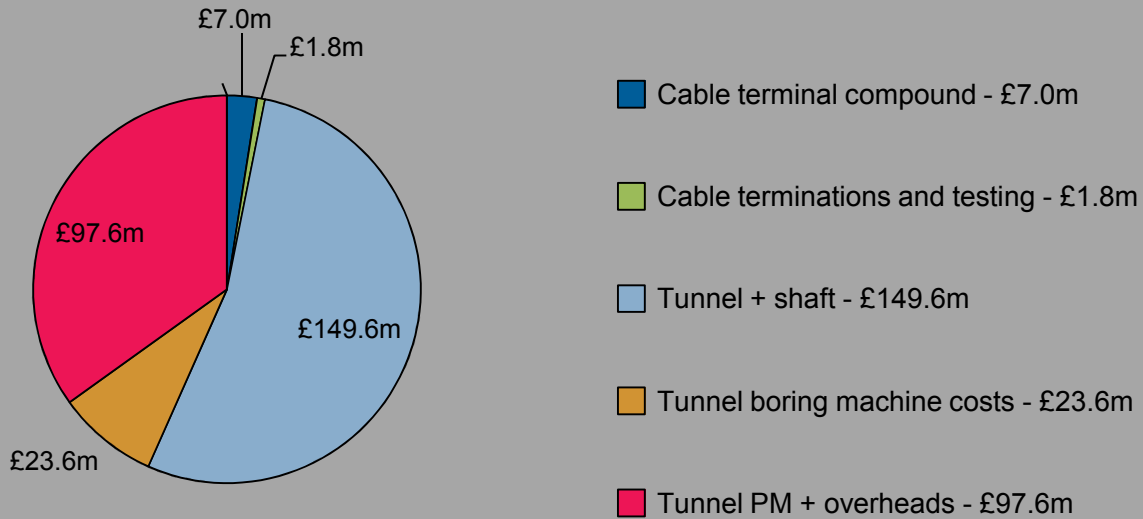

Variable Build Costs (£1607.0m)

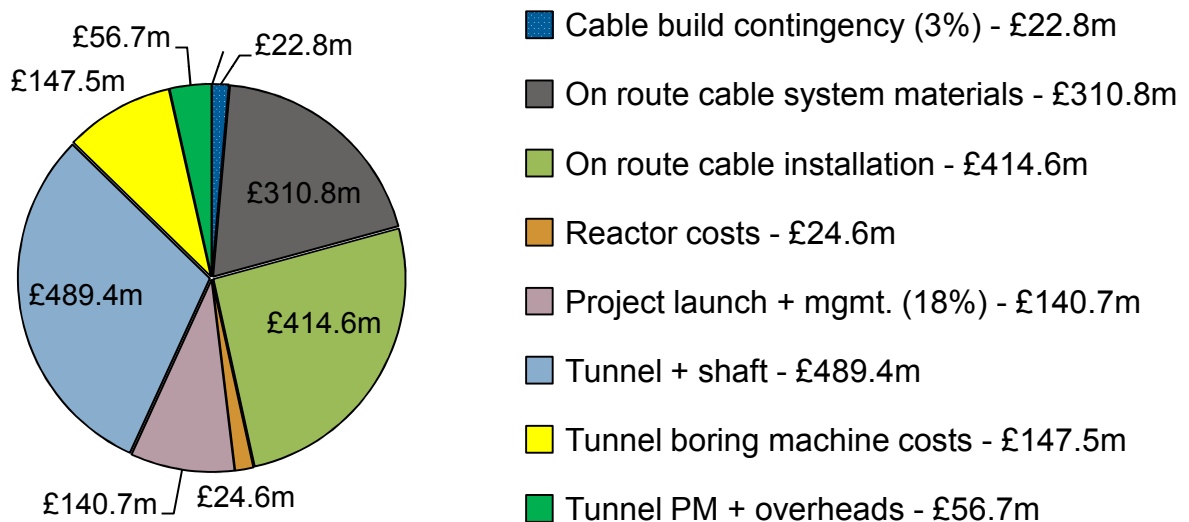

Variable Operating Costs (£174.0m)

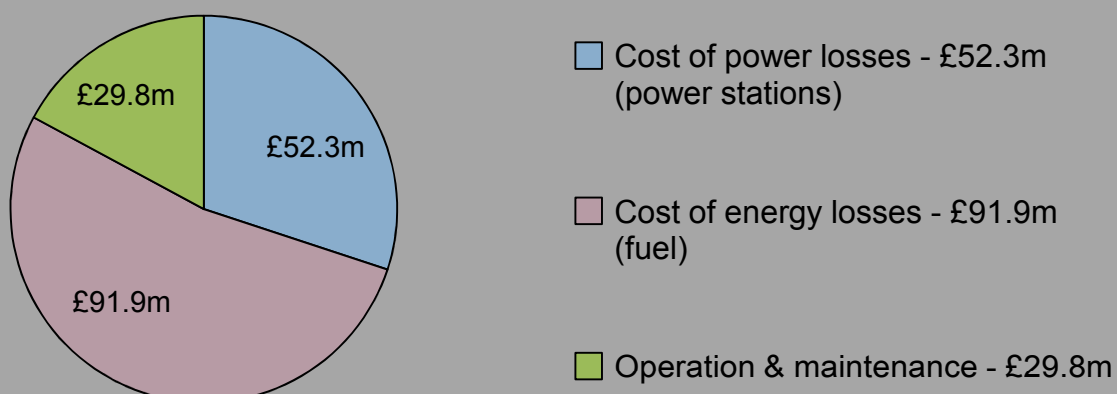

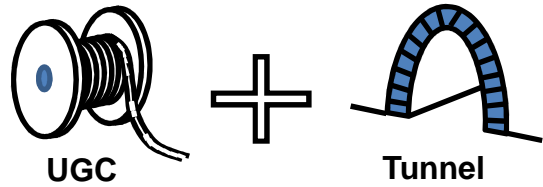

Cost Sensitivities

Legend: ■ = lower, Lifetime cost = 0%, ■ = upper

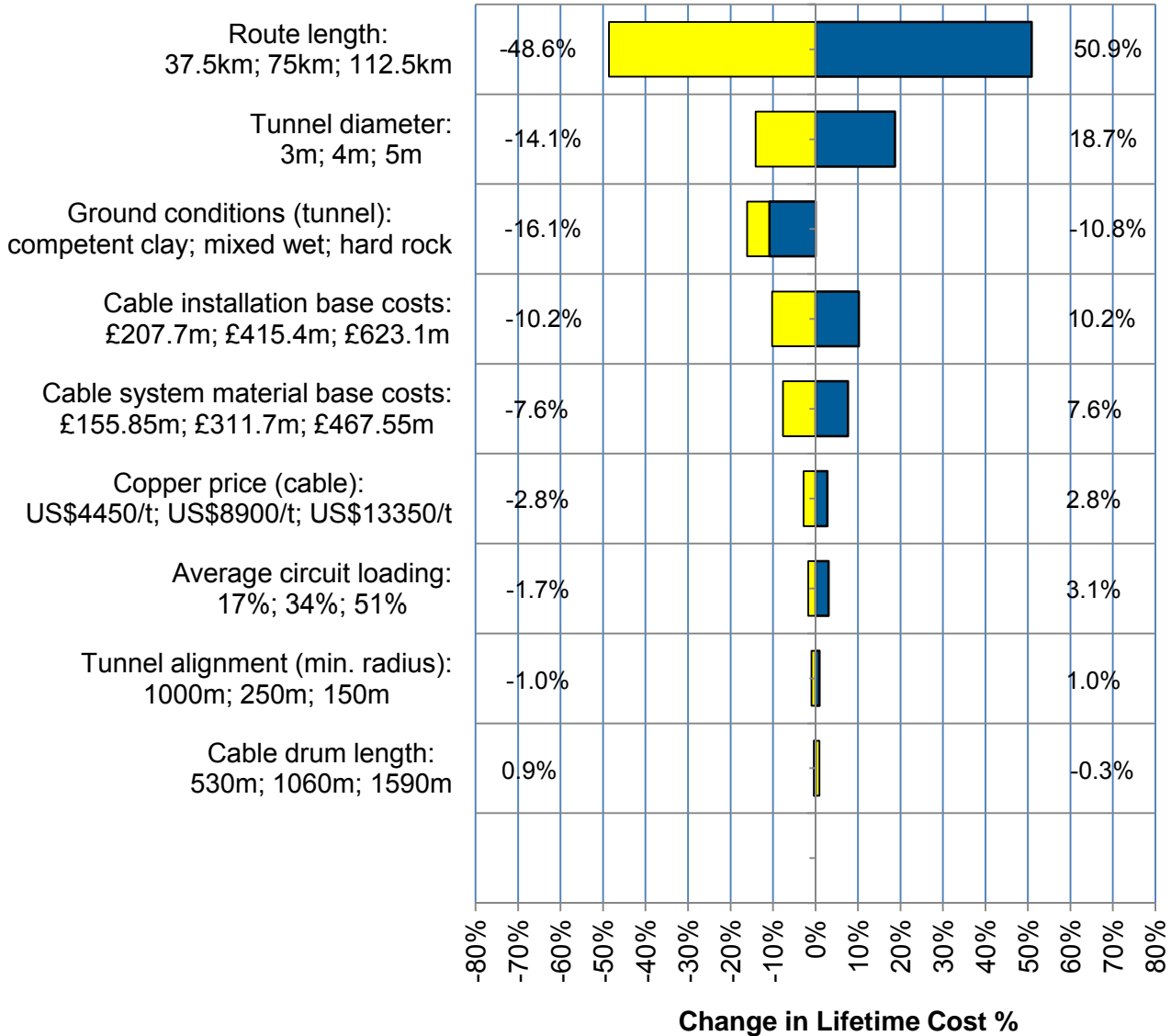

Underground cable

Lifetime Cost Results (£27.5m/km; £4310/MVA-km)

| | |
|---|---------------------|
| Fixed Build Cost | £279.6m |
| Variable Build Cost | £1607.0m |
| Build Cost Total for 75km | £1886.6m |
| plus Variable Operating Cost | £174.0m |
| Lifetime Cost for 75km | £2060.5m |
| ↓ | |
| Lifetime Cost for 75km divided by route length ÷ 75km | £2060.5m |
| Lifetime Cost per km | £27.5m/km |
| ↓ | |
| Lifetime Cost per km divided by Power Transfer ÷ 6380 MVA | £27.5m/km |
| Lifetime PTC* per km | £4310/MVA-km |

Other Results
Losses = 7% of Lifetime Cost for 75km

Costs most sensitive to:

- Route length: -48.6% to 50.9%
- Tunnel diameter: -14.1% to 18.7%

Notes (Jan-12)

* PTC = Power Transfer Cost

Tunnel

AC Underground Cable (tunnel)

75km Route Lifetime Cost: £2112.4m

Hi capacity (6930 MVA); 400 kV AC

Fixed Build Costs (£279.6m)

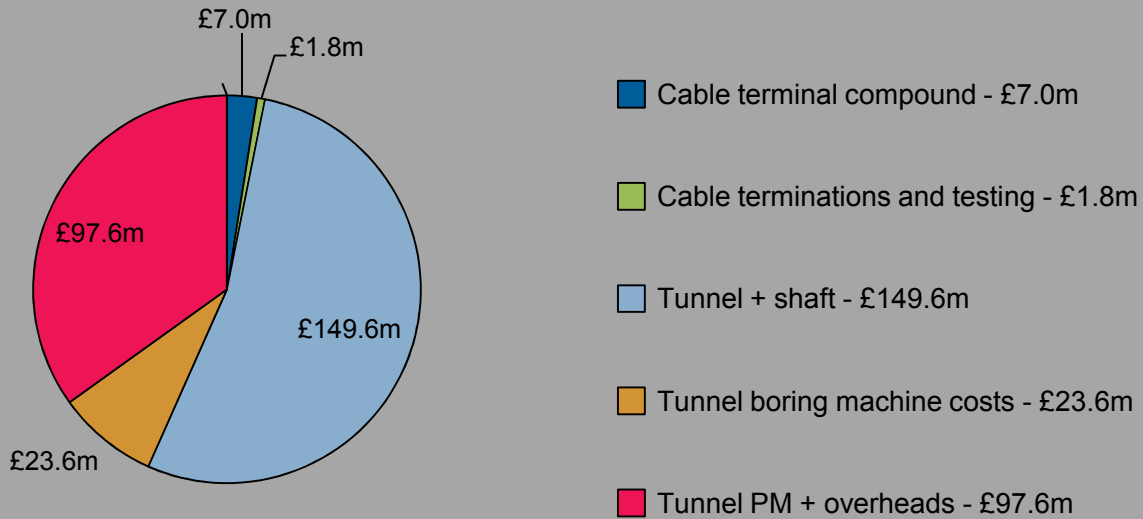

Variable Build Costs (£1653.0m)

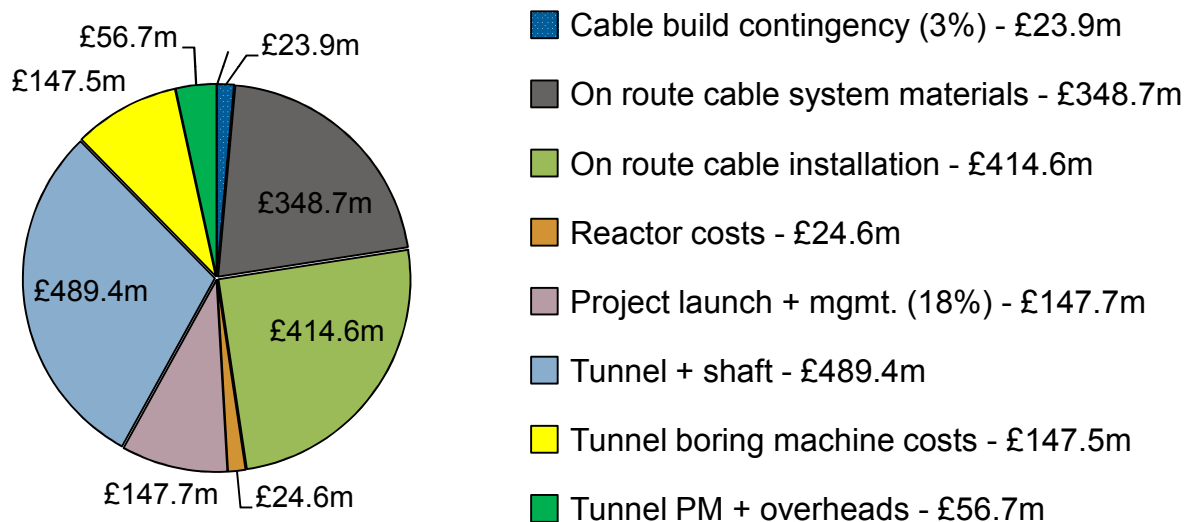

Variable Operating Costs (£179.8m)

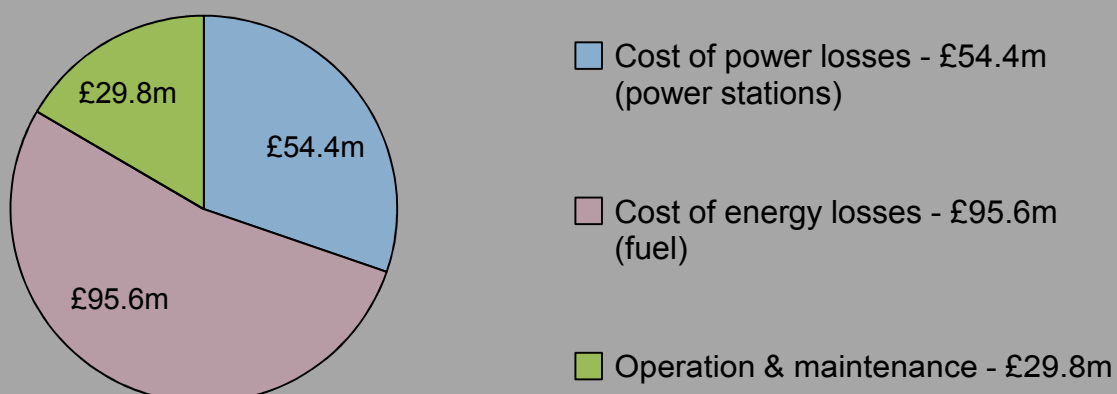

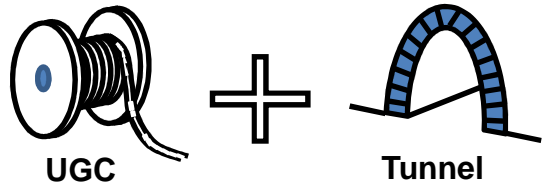

Cost Sensitivities

= lower
 Lifetime cost = 0%
 upper =

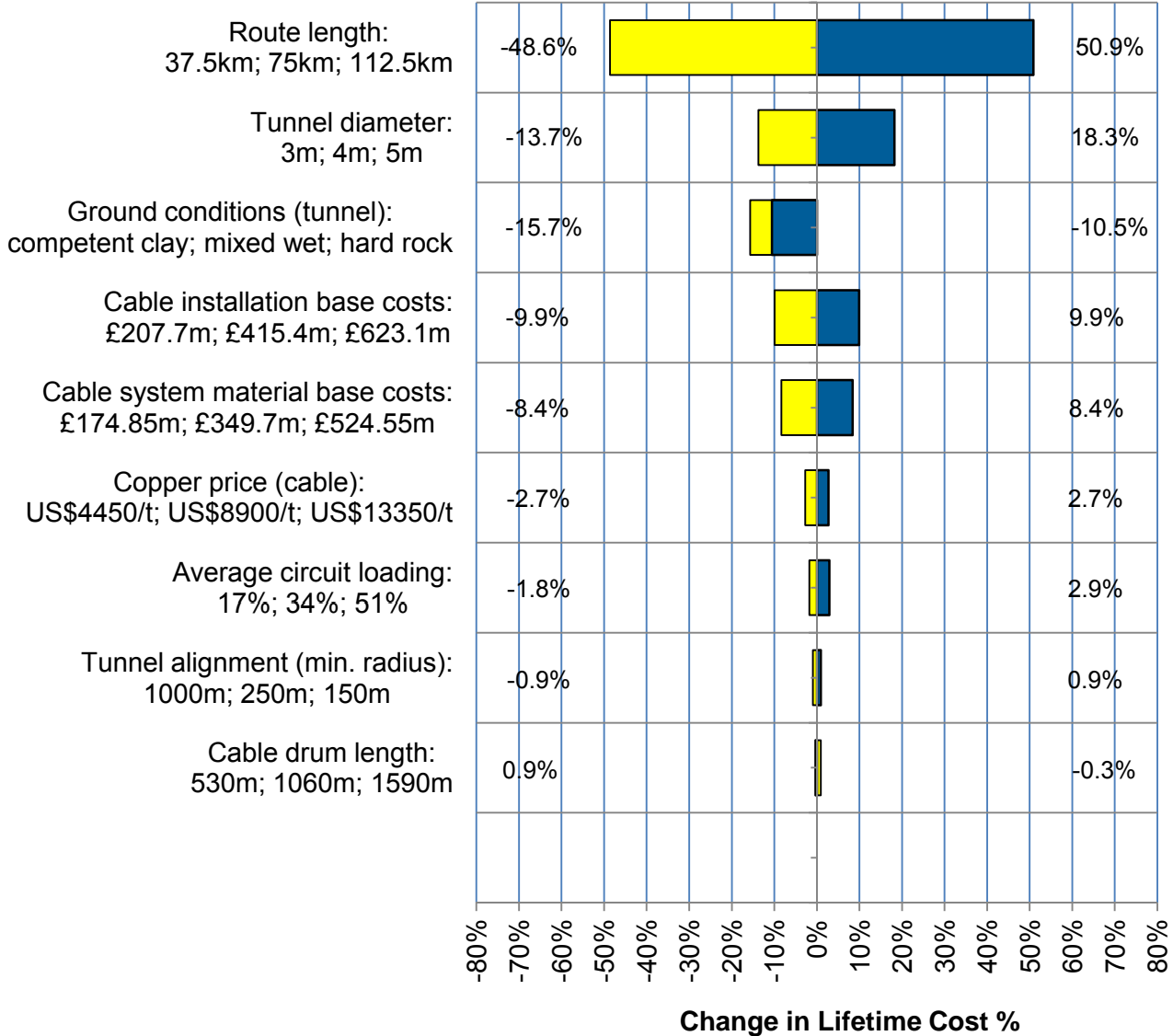

Underground cable

Lifetime Cost Results (£28.2m/km; £4060/MVA-km)

| | |
|---|---------------------|
| Fixed Build Cost | £279.6m |
| Variable Build Cost | £1653.0m |
| Build Cost Total for 75km | £1932.6m |
| plus Variable Operating Cost | £179.8m |
| Lifetime Cost for 75km | £2112.4m |
| ↓ | |
| Lifetime Cost for 75km divided by route length ÷ 75km | £2112.4m |
| Lifetime Cost per km | £28.2m/km |
| ↓ | |
| Lifetime Cost per km divided by Power Transfer ÷ 6930 MVA | £28.2m/km |
| Lifetime PTC* per km | £4060/MVA-km |

Other Results
Losses = 7% of Lifetime Cost for 75km

Costs most sensitive to:

- Route length: -48.6% to 50.9%
- Tunnel diameter: -13.7% to 18.3%

Notes (Jan-12)

* PTC = Power Transfer Cost

Tunnel

Cost charts for gas insulated line

The following charts present the lifetime cost make-up and associated sensitivities on lifetime cost for the gas insulated line electricity transmission options: direct-buried and in tunnels.

Figure 4 – Short section of gas insulated line, by Siemens

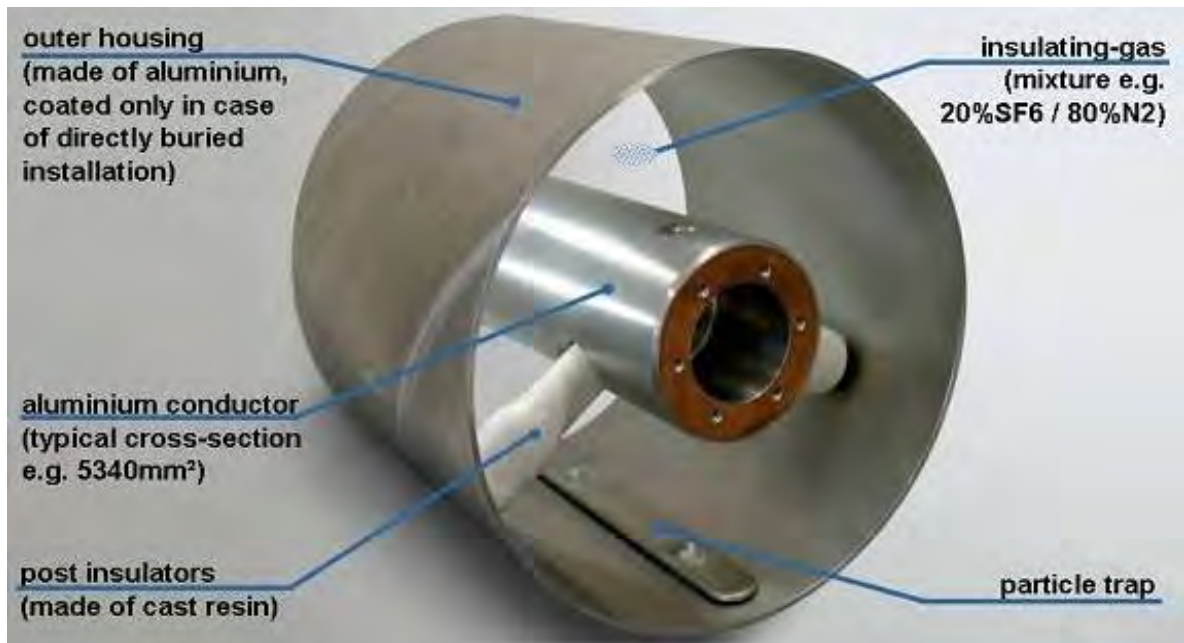

(Photo courtesy of Siemens)

AC Gas Insulated Line (direct-buried)

3km Route Lifetime Cost: £48.6m

Lo capacity (3190 MVA); 400 kV AC

Fixed Build Costs (£7.4m)

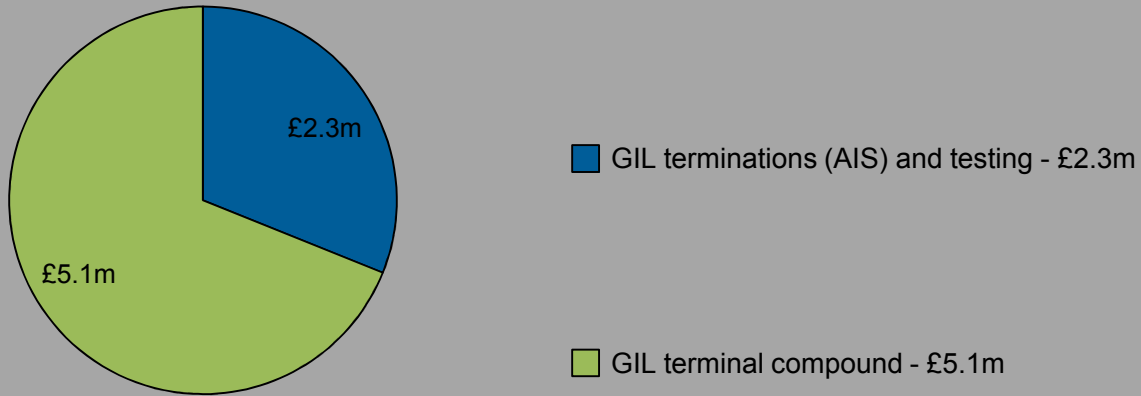

Variable Build Costs (£39.7m)

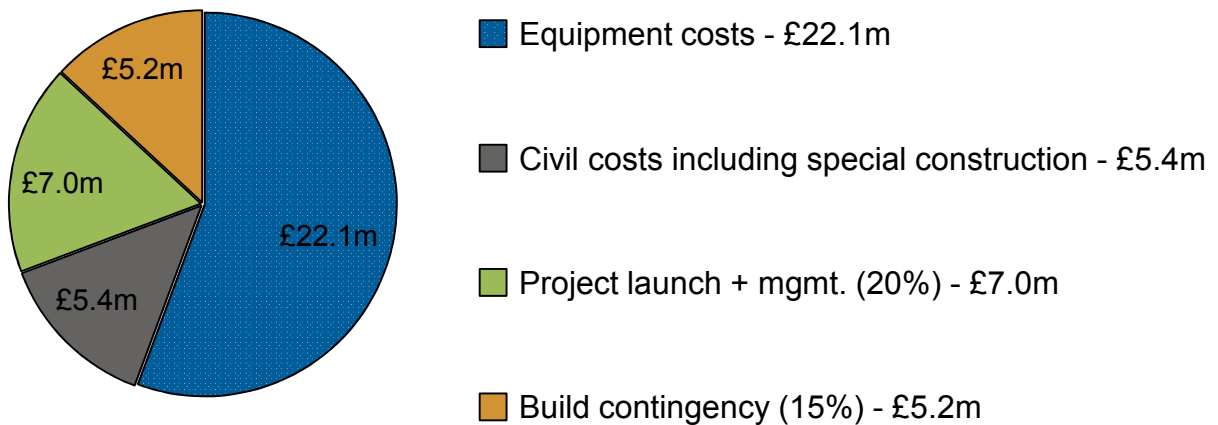

Variable Operating Costs (£1.4m)

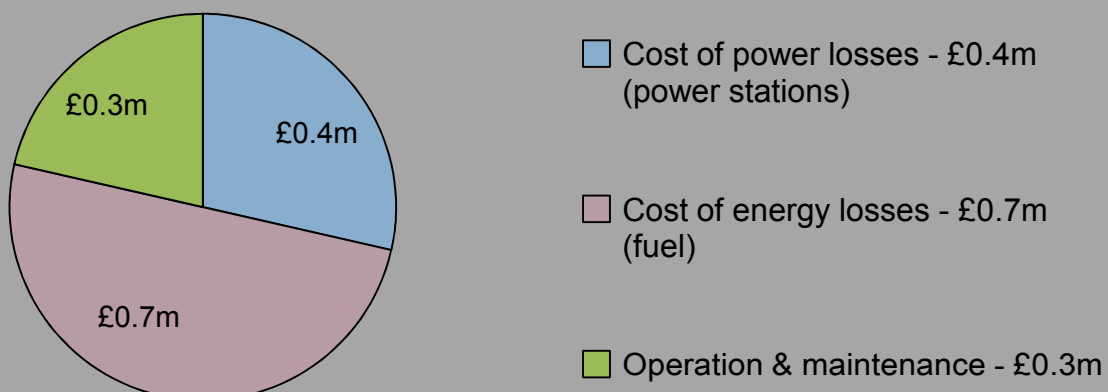

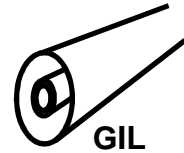

Cost Sensitivities

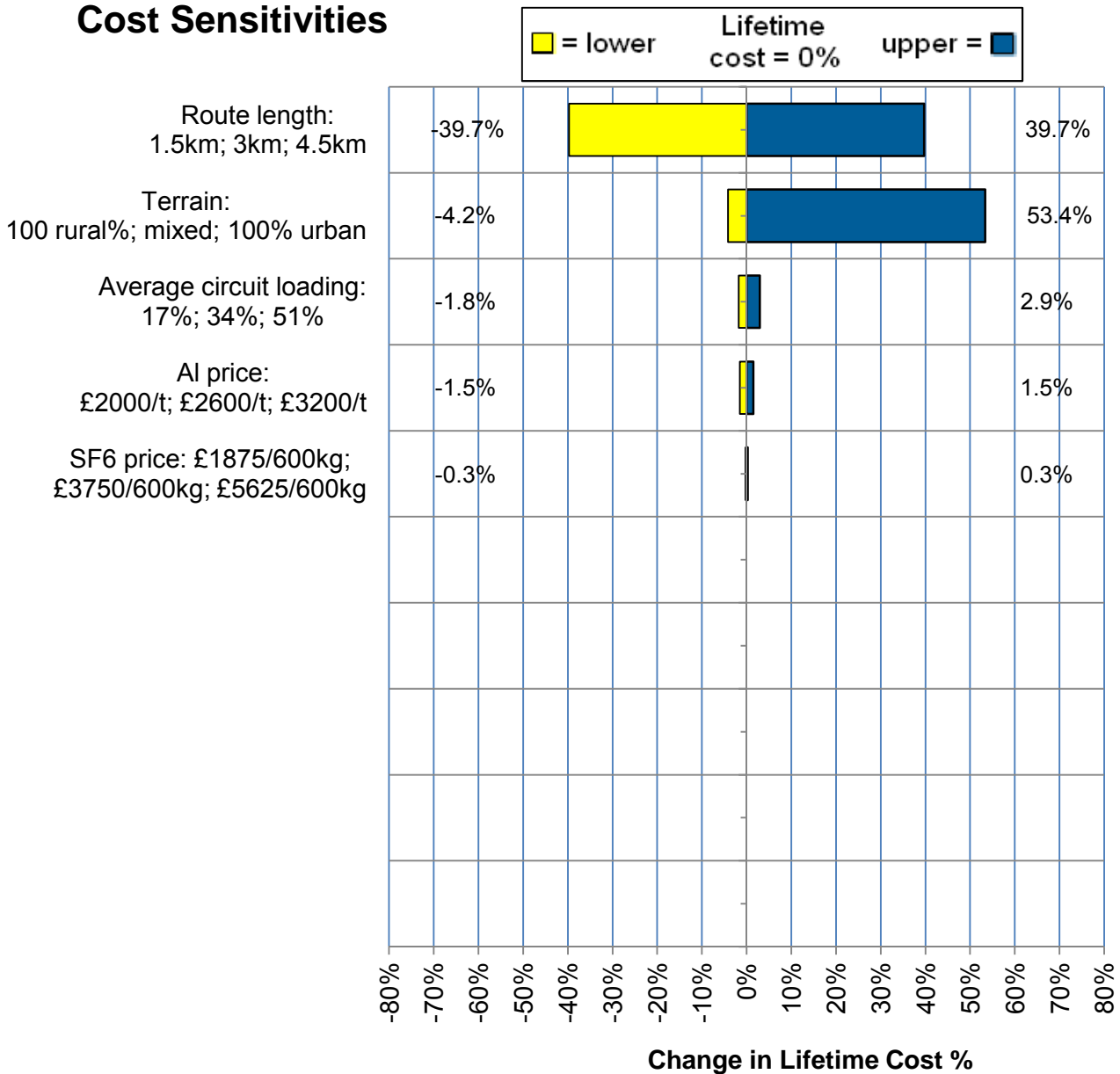

Lifetime Cost Results (£16.2m/km; £5080/MVA-km)

| | |
|---------------------------------|---------------|
| Fixed Build Cost | £7.4m |
| Variable Build Cost | £39.7m |
| Build Cost Total for 3km | £47.1m |
| plus Variable Operating Cost | £1.4m |
| Lifetime Cost for 3km | £48.6m |

| | |
|---|------------------|
| Lifetime Cost for 3km divided by route length ÷ 3km | £48.6m ÷ 3km |
| Lifetime Cost per km | £16.2m/km |

| | |
|---|----------------------|
| Lifetime Cost per km divided by Power Transfer ÷ 3190 MVA | £16.2m/km ÷ 3190 MVA |
| Lifetime PTC* per km | £5080/MVA-km |

Other Results

Losses = 2% of Lifetime Cost for 3km

Costs most sensitive to:

- Route length: -39.7% to 39.7%
- Terrain: -4.2% to 53.4%

Notes (Jan-12)

* PTC = Power Transfer Cost

Gas Insulated Line

AC Gas Insulated Line (direct-buried)

15km Route Lifetime Cost: £204m

Lo capacity (3190 MVA); 400 kV AC

Fixed Build Costs (£7.4m)

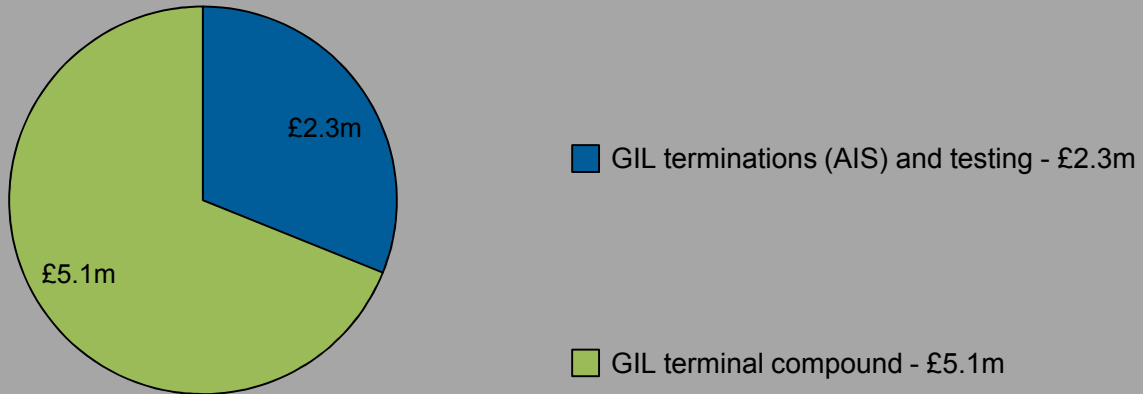

Variable Build Costs (£189.2m)

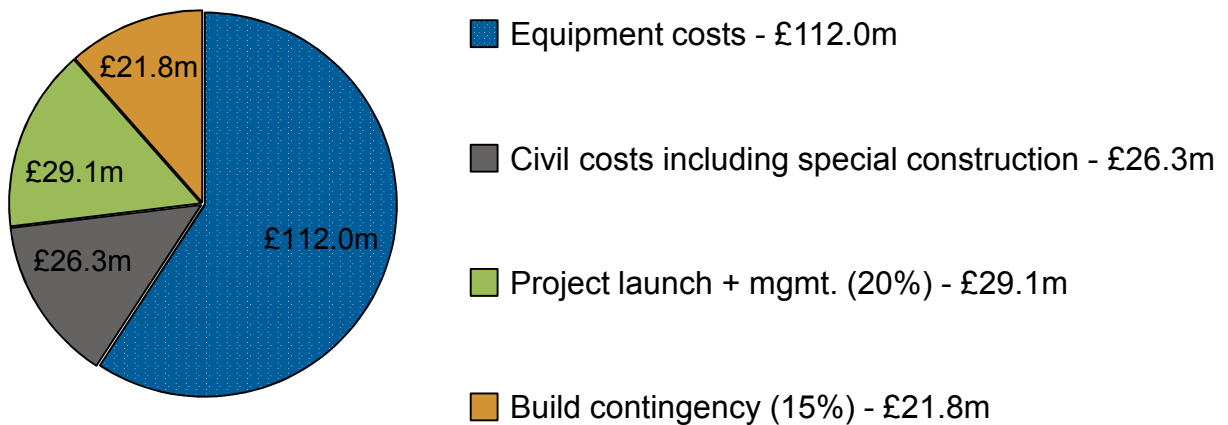

Variable Operating Costs (£7.4m)

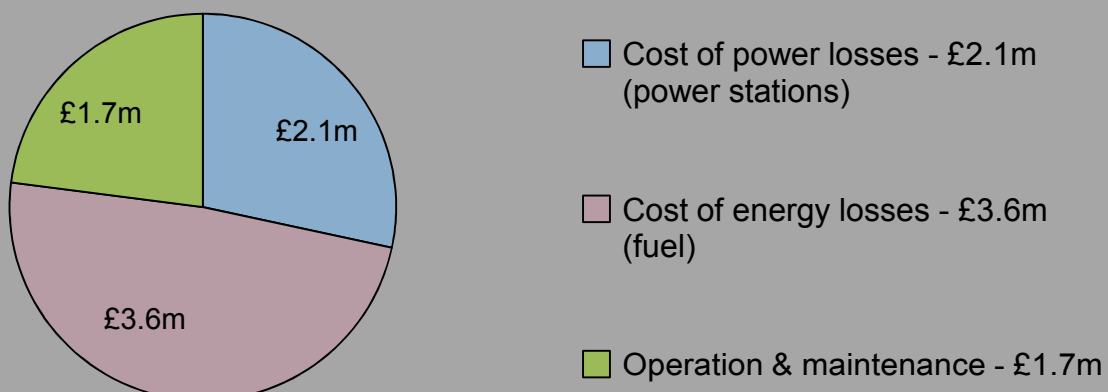

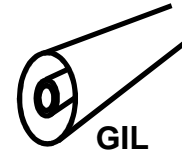

Cost Sensitivities

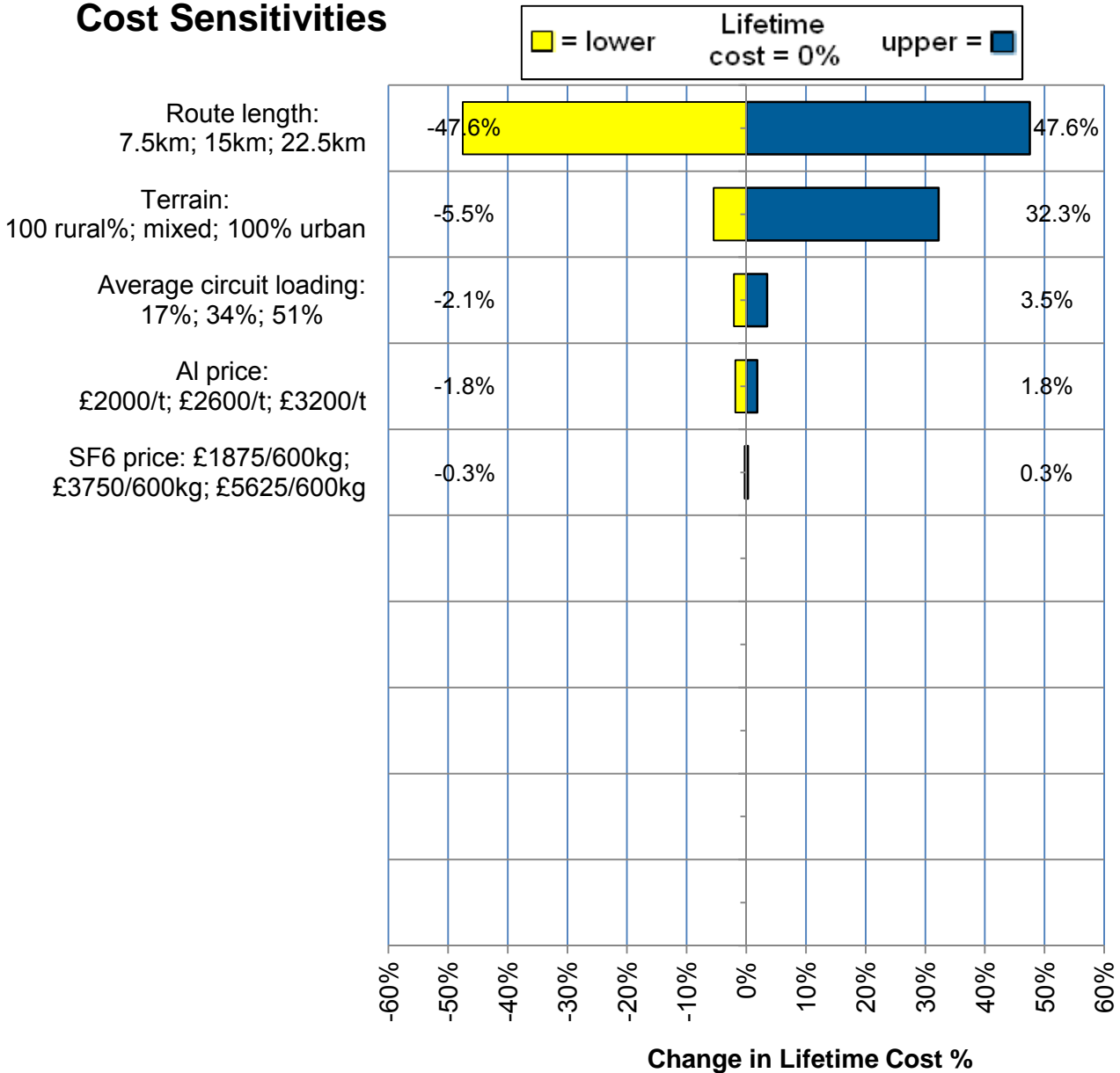

Lifetime Cost Results (£13.6m/km; £4260/MVA-km)

| | |
|----------------------------------|----------------|
| Fixed Build Cost | £7.4m |
| Variable Build Cost | £189.2m |
| Build Cost Total for 15km | £196.6m |
| plus Variable Operating Cost | £7.4m |
| Lifetime Cost for 15km | £204.0m |

| | |
|--|------------------|
| Lifetime Cost for 15km divided by route length | £204.0m ÷ 15km |
| Lifetime Cost per km | £13.6m/km |

| | |
|--|----------------------|
| Lifetime Cost per km divided by Power Transfer | £13.6m/km ÷ 3190 MVA |
| Lifetime PTC* per km | £4260/MVA-km |

Other Results

Losses = 3% of Lifetime Cost for 15km

Costs most sensitive to:

- Route length:
-47.6% to 47.6%
- Terrain:
-5.5% to 32.3%

Notes (Jan-12)

* PTC = Power Transfer Cost

Gas Insulated Line

AC Gas Insulated Line (direct-buried)

75km Route Lifetime Cost: £982.1m

Lo capacity (3190 MVA); 400 kV AC

Fixed Build Costs (£7.4m)

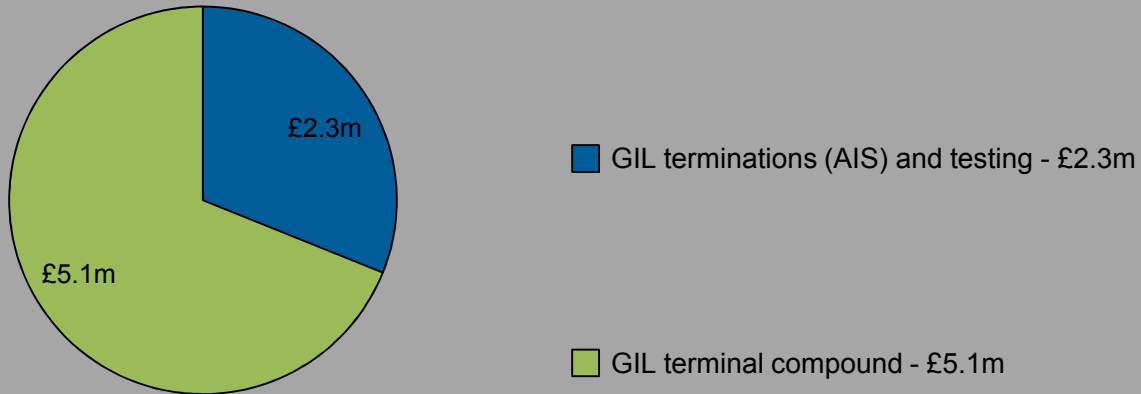

Variable Build Costs (£937.4m)

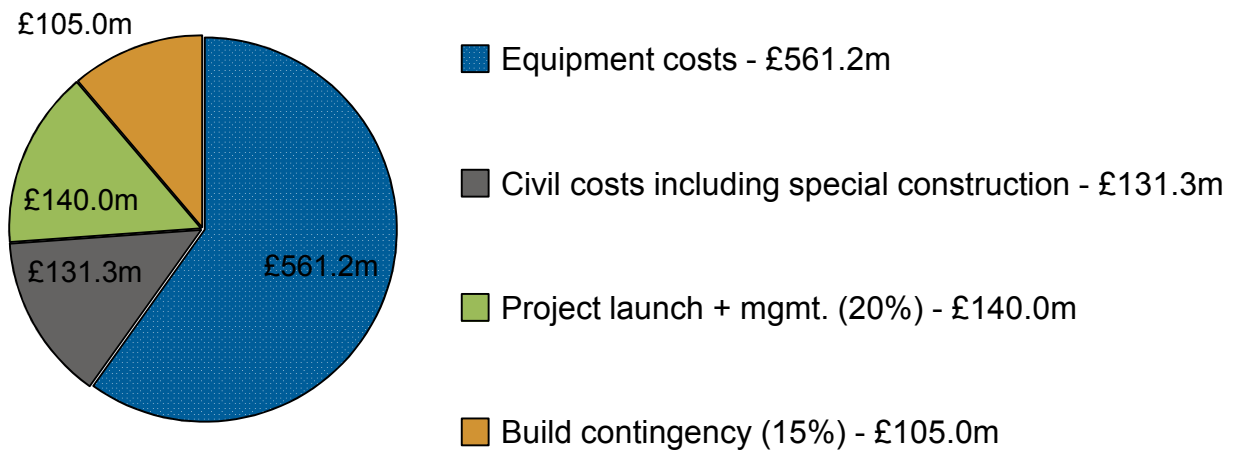

Variable Operating Costs (£37.3m)

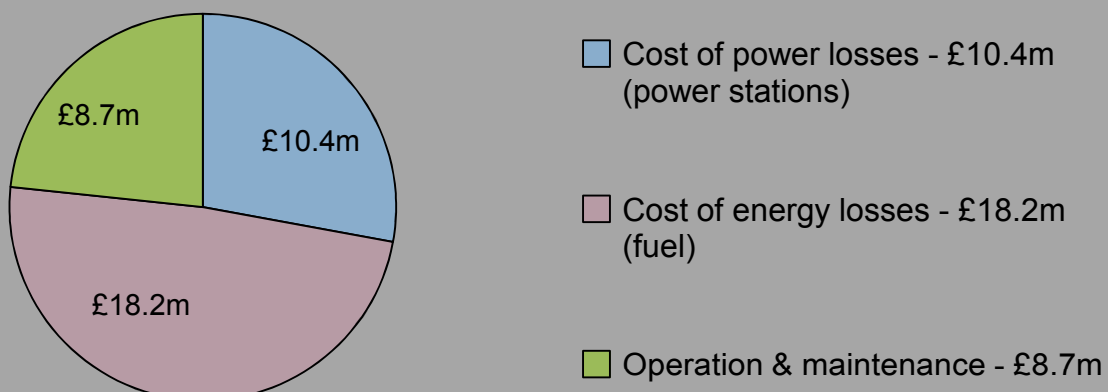

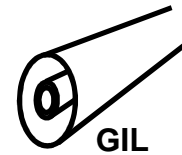

Cost Sensitivities

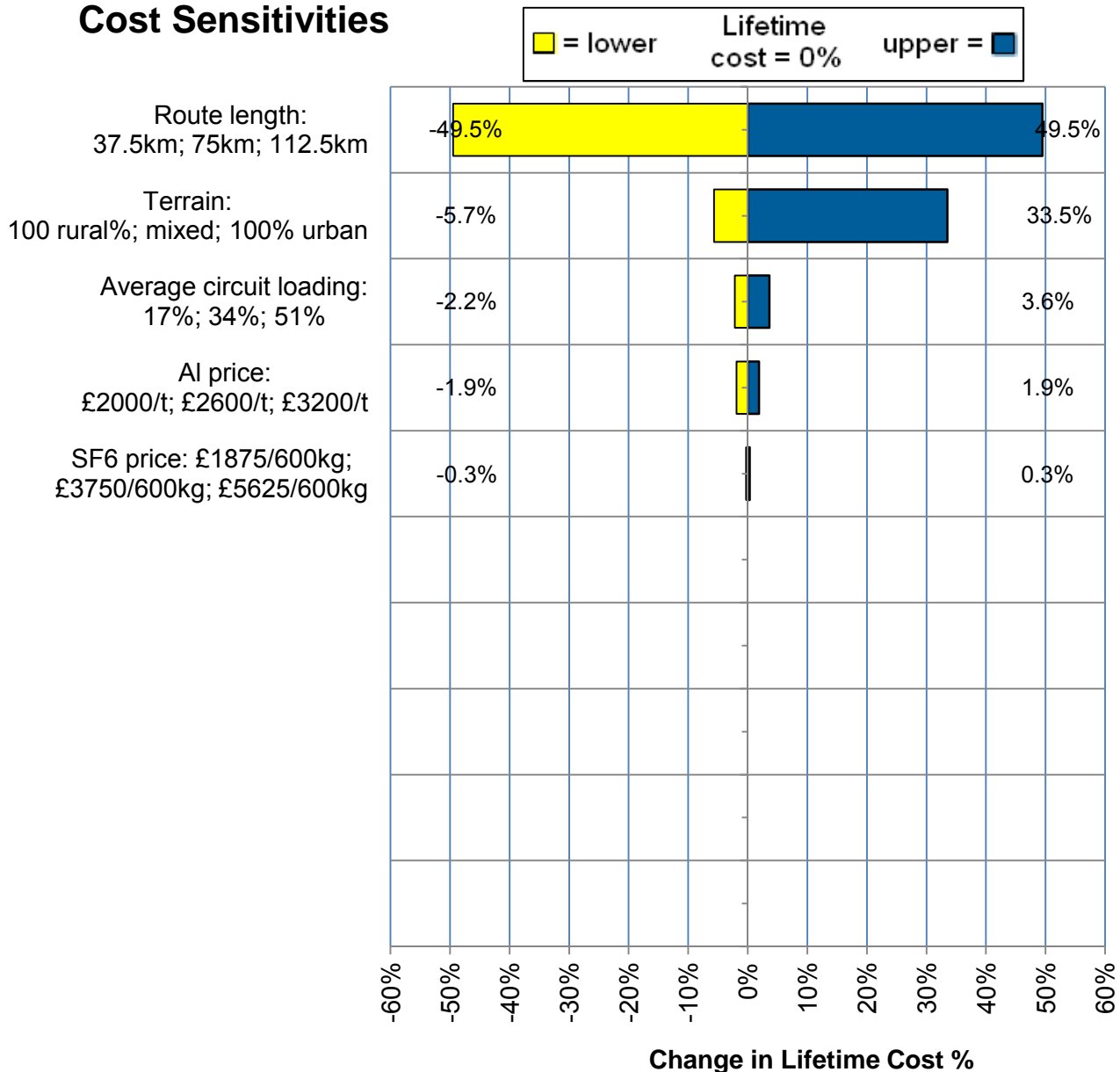

Lifetime Cost Results (£13.1m/km; £4100/MVA-km)

| | |
|----------------------------------|----------------|
| Fixed Build Cost | £7.4m |
| Variable Build Cost | £937.4m |
| Build Cost Total for 75km | £944.8m |
| plus Variable Operating Cost | £37.3m |
| Lifetime Cost for 75km | £982.1m |

| | |
|---|-------------------|
| Lifetime Cost for 75km divided by route length | £982.1m ÷ 75km |
| Lifetime Cost per km | £13.1m/km |

| | |
|---|-------------------------|
| Lifetime Cost per km divided by Power Transfer | £13.1m/km ÷ 3190 MVA |
| Lifetime PTC* per km | £4100/MVA-km |

Other Results

Losses = 3% of Lifetime Cost for 75km

Costs most sensitive to:

- Route length:
-49.5% to 49.5%
- Terrain:
-5.7% to 33.5%

Notes (Jan-12)

* PTC = Power Transfer Cost

Gas Insulated
Line

AC Gas Insulated Line (tunnel)

3km Route Lifetime Cost: £111.4m

Lo capacity (3190 MVA); 400 kV AC

Fixed Build Costs (£51.8m)

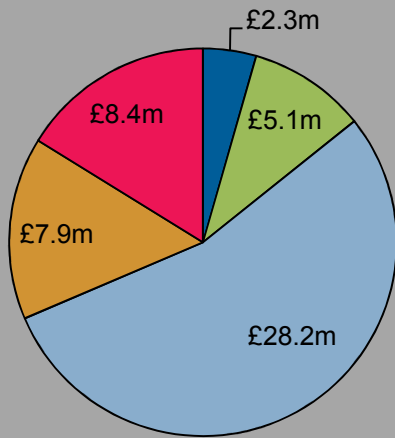

- GIL terminations (AIS) and testing - £2.3m
- GIL terminal compound - £5.1m
- Tunnel + shaft - £28.2m
- Tunnel boring machine costs - £7.9m
- Tunnel PM + overheads - £8.4m

Variable Build Costs (£57.6m)

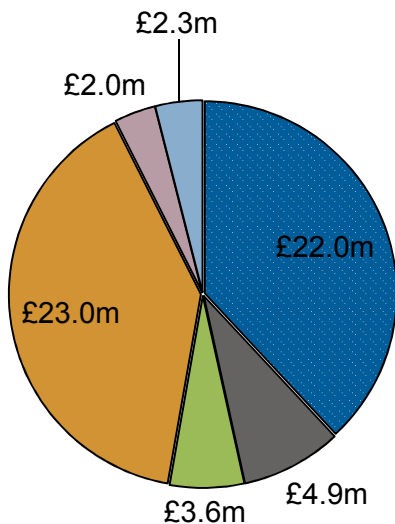

- Equipment costs - £22.0m
- Project launch + mgmt. (20%) - £4.9m
- Build contingency (GIL) (15%) - £3.6m
- Tunnel + shaft - £23.0m
- Tunnel boring machine costs - £2.0m
- Tunnel PM + overheads - £2.3m

Variable Operating Costs (£1.9m)

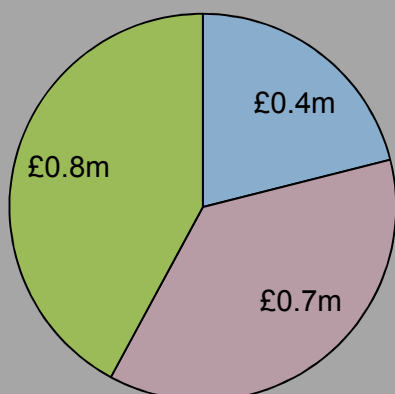

- Cost of power losses - £0.4m (power stations)
- Cost of energy losses - £0.7m (fuel)
- Operation & maintenance - £0.8m

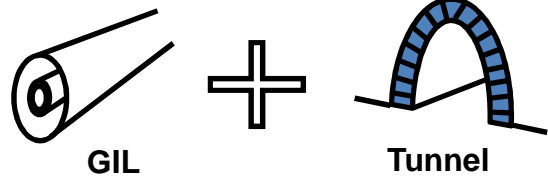

Cost Sensitivities

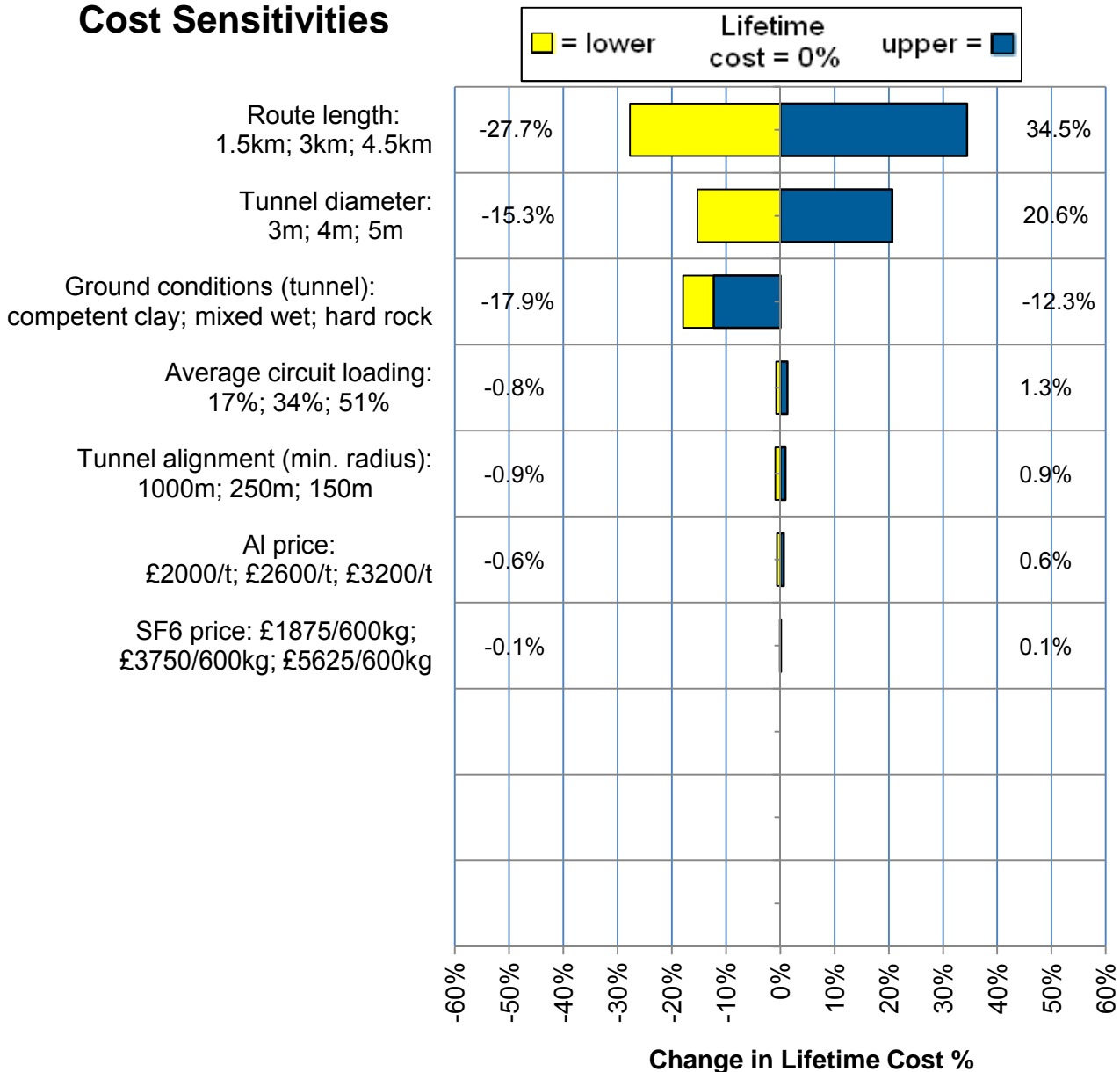

Lifetime Cost Results (£37.1m/km; £11640/MVA-km)

| | |
|---------------------------------|----------------|
| Fixed Build Cost | £51.8m |
| Variable Build Cost | £57.6m |
| Build Cost Total for 3km | £109.4m |
| plus Variable Operating Cost | £1.9m |
| Lifetime Cost for 3km | £111.4m |

| | |
|---|------------------|
| Lifetime Cost for 3km divided by route length ÷ 3km | £111.4m |
| Lifetime Cost per km | £37.1m/km |

| | |
|---|----------------------|
| Lifetime Cost per km divided by Power Transfer ÷ 3190 MVA | £37.1m/km |
| Lifetime PTC* per km | £11640/MVA-km |

Other Results

Losses = 1% of Lifetime Cost for 3km

Costs most sensitive to:

- Route length:
-27.7% to 34.5%
- Tunnel diameter:
-15.3% to 20.6%

Notes (Jan-12)

* PTC = Power Transfer Cost

Gas Insulated
Line

Tunnel

AC Gas Insulated Line (tunnel)

3km Route Lifetime Cost: £115.3m

Med capacity (6380 MVA); 400 kV AC

Fixed Build Costs (£51.8m)

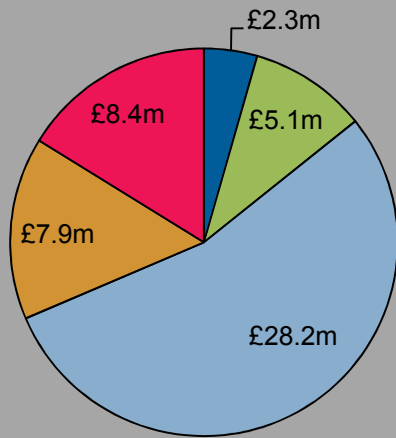

- GIL terminations (AIS) and testing - £2.3m
- GIL terminal compound - £5.1m
- Tunnel + shaft - £28.2m
- Tunnel boring machine costs - £7.9m
- Tunnel PM + overheads - £8.4m

Variable Build Costs (£57.6m)

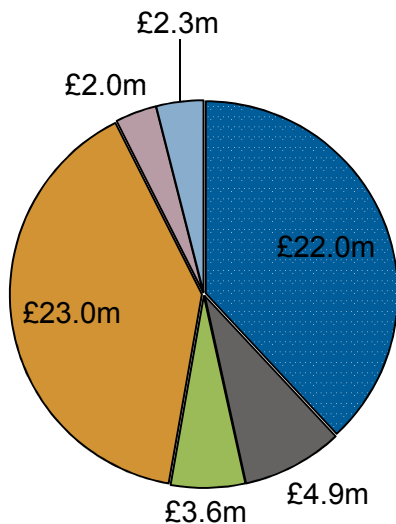

- Equipment costs - £22.0m
- Project launch + mgmt. (20%) - £4.9m
- Build contingency (GIL) (15%) - £3.6m
- Tunnel + shaft - £23.0m
- Tunnel boring machine costs - £2.0m
- Tunnel PM + overheads - £2.3m

Variable Operating Costs (£5.8m)

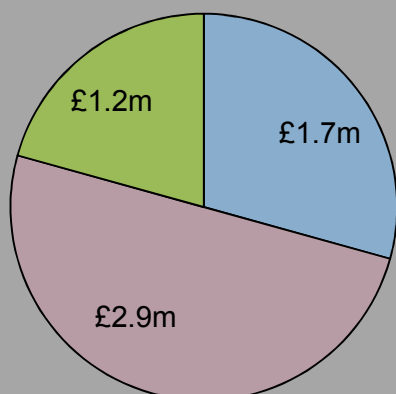

- Cost of power losses - £1.7m (power stations)
- Cost of energy losses - £2.9m (fuel)
- Operation & maintenance - £1.2m

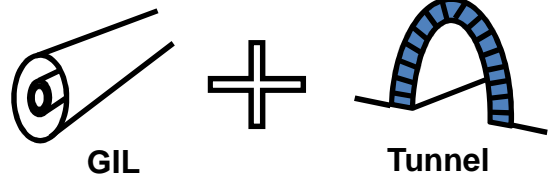

Cost Sensitivities

= lower
 Lifetime cost = 0%
 upper =

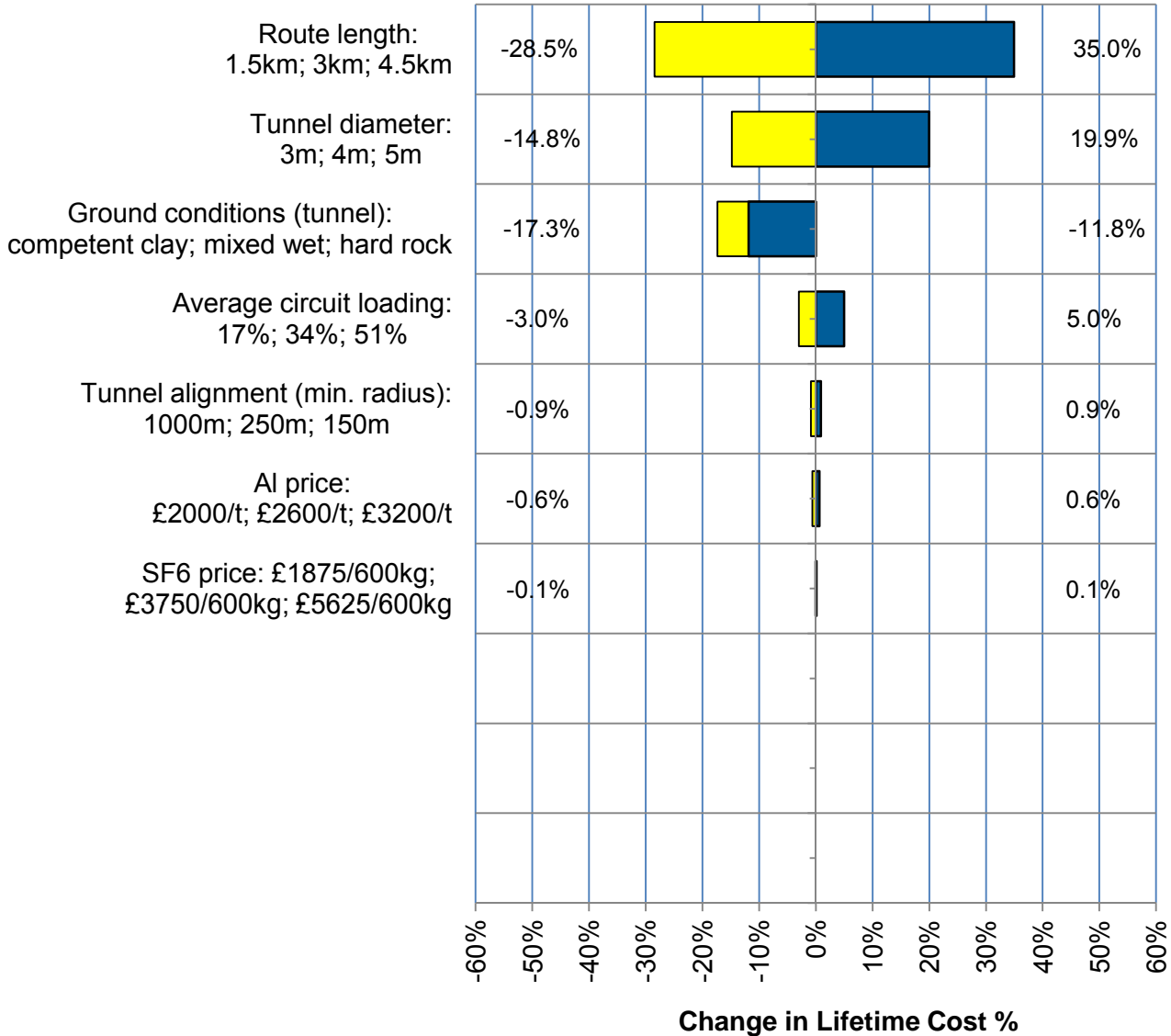

Lifetime Cost Results (£38.4m/km; £6020/MVA-km)

| | |
|---------------------------------|----------------|
| Fixed Build Cost | £51.8m |
| Variable Build Cost | £57.6m |
| Build Cost Total for 3km | £109.4m |
| plus Variable Operating Cost | £5.8m |
| Lifetime Cost for 3km | £115.3m |

| | |
|---|------------------|
| Lifetime Cost for 3km divided by route length | £115.3m ÷ 3km |
| Lifetime Cost per km | £38.4m/km |

| | |
|--|----------------------|
| Lifetime Cost per km divided by Power Transfer | £38.4m/km ÷ 6380 MVA |
| Lifetime PTC* per km | £6020/MVA-km |

Other Results

Losses = 4% of Lifetime Cost for 3km

Costs most sensitive to:

- Route length: -28.5% to 35%
- Tunnel diameter: -14.8% to 19.9%

Notes (Jan-12)

* PTC = Power Transfer Cost

Gas Insulated Line
Tunnel

AC Gas Insulated Line (tunnel)

3km Route Lifetime Cost: £116.1m

Hi capacity (6930 MVA); 400 kV AC

Fixed Build Costs (£51.8m)

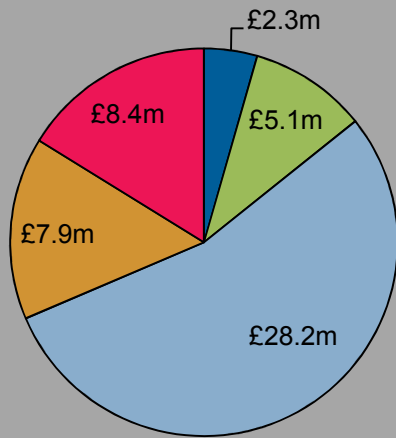

- GIL terminations (AIS) and testing - £2.3m
- GIL terminal compound - £5.1m
- Tunnel + shaft - £28.2m
- Tunnel boring machine costs - £7.9m
- Tunnel PM + overheads - £8.4m

Variable Build Costs (£57.6m)

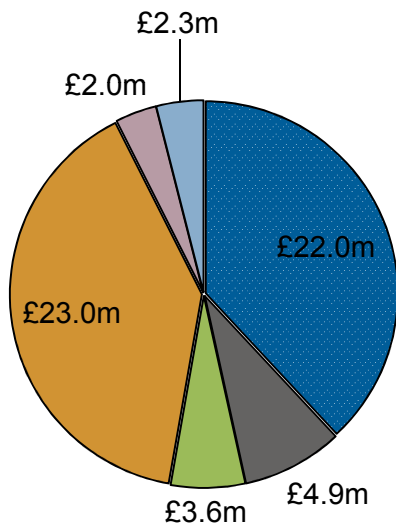

- Equipment costs - £22.0m
- Project launch + mgmt. (20%) - £4.9m
- Build contingency (GIL) (15%) - £3.6m
- Tunnel + shaft - £23.0m
- Tunnel boring machine costs - £2.0m
- Tunnel PM + overheads - £2.3m

Variable Operating Costs (£6.6m)

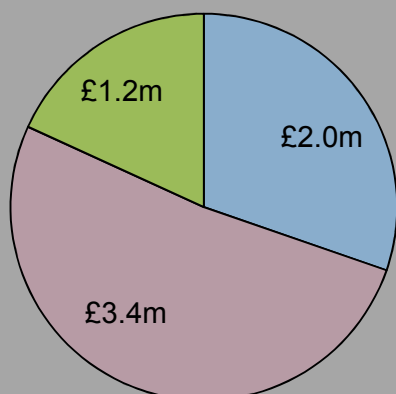

- Cost of power losses - £2.0m (power stations)
- Cost of energy losses - £3.4m (fuel)
- Operation & maintenance - £1.2m

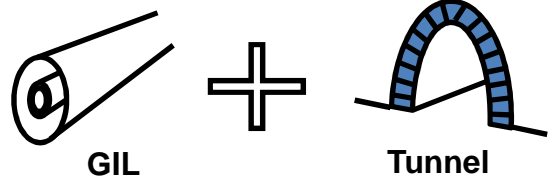

Cost Sensitivities

= lower
 Lifetime cost = 0%
 upper =

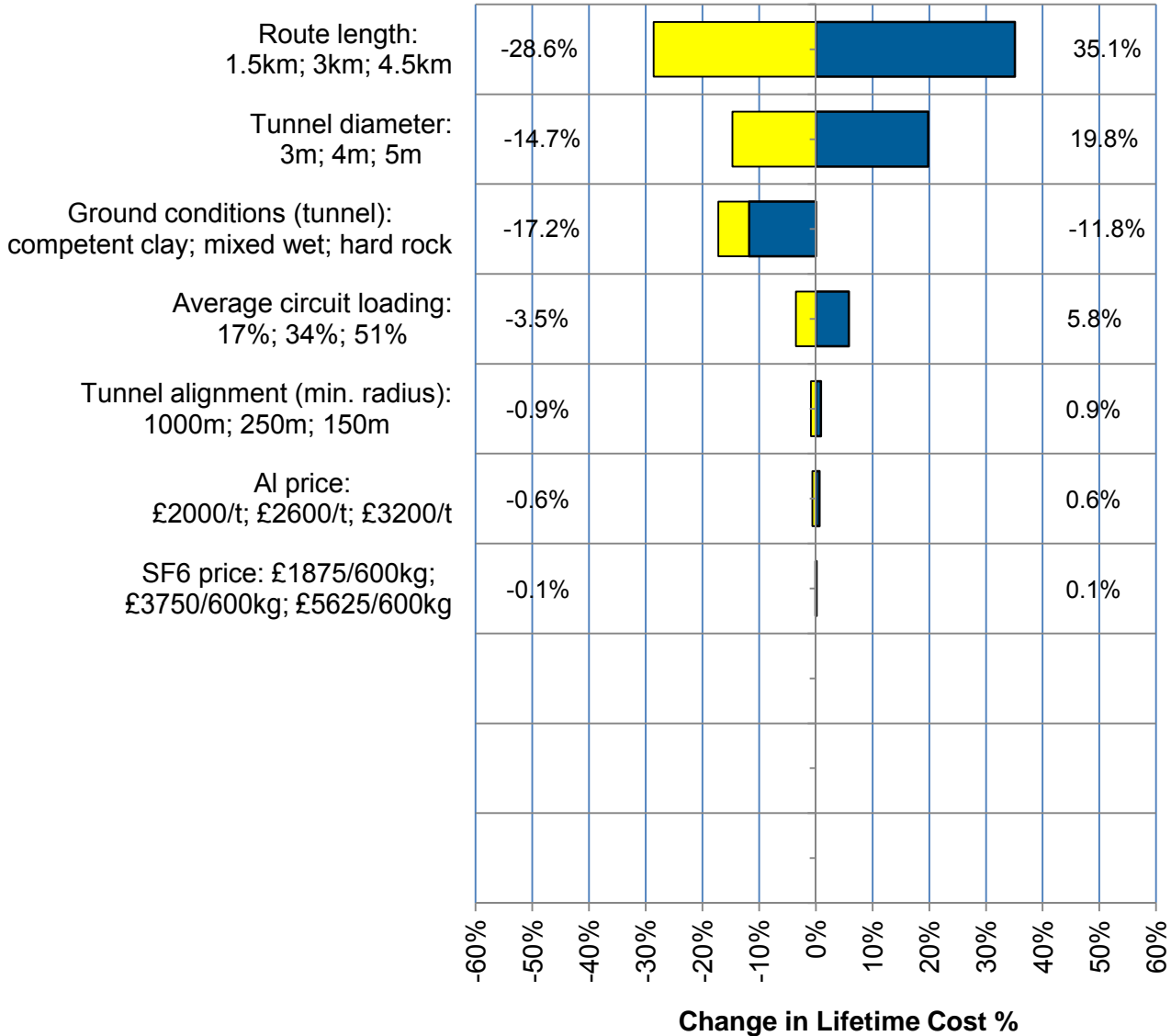

Lifetime Cost Results (£38.7m/km; £5590/MVA-km)

| | |
|---------------------------------|----------------|
| Fixed Build Cost | £51.8m |
| Variable Build Cost | £57.6m |
| Build Cost Total for 3km | £109.4m |
| plus Variable Operating Cost | £6.6m |
| Lifetime Cost for 3km | £116.1m |

| | |
|---|------------------|
| Lifetime Cost for 3km divided by route length ÷ 3km | £116.1m ÷ 3km |
| Lifetime Cost per km | £38.7m/km |

| | |
|---|----------------------|
| Lifetime Cost per km divided by Power Transfer ÷ 6930 MVA | £38.7m/km ÷ 6930 MVA |
| Lifetime PTC* per km | £5590/MVA-km |

Other Results

Losses = 5% of Lifetime Cost for 3km

Costs most sensitive to:

- Route length: -28.6% to 35.1%
- Tunnel diameter: -14.7% to 19.8%

Notes (Jan-12)

* PTC = Power Transfer Cost

Gas Insulated Line
Tunnel

AC Gas Insulated Line (tunnel)

15km Route Lifetime Cost: £384.8m

Lo capacity (3190 MVA); 400 kV AC

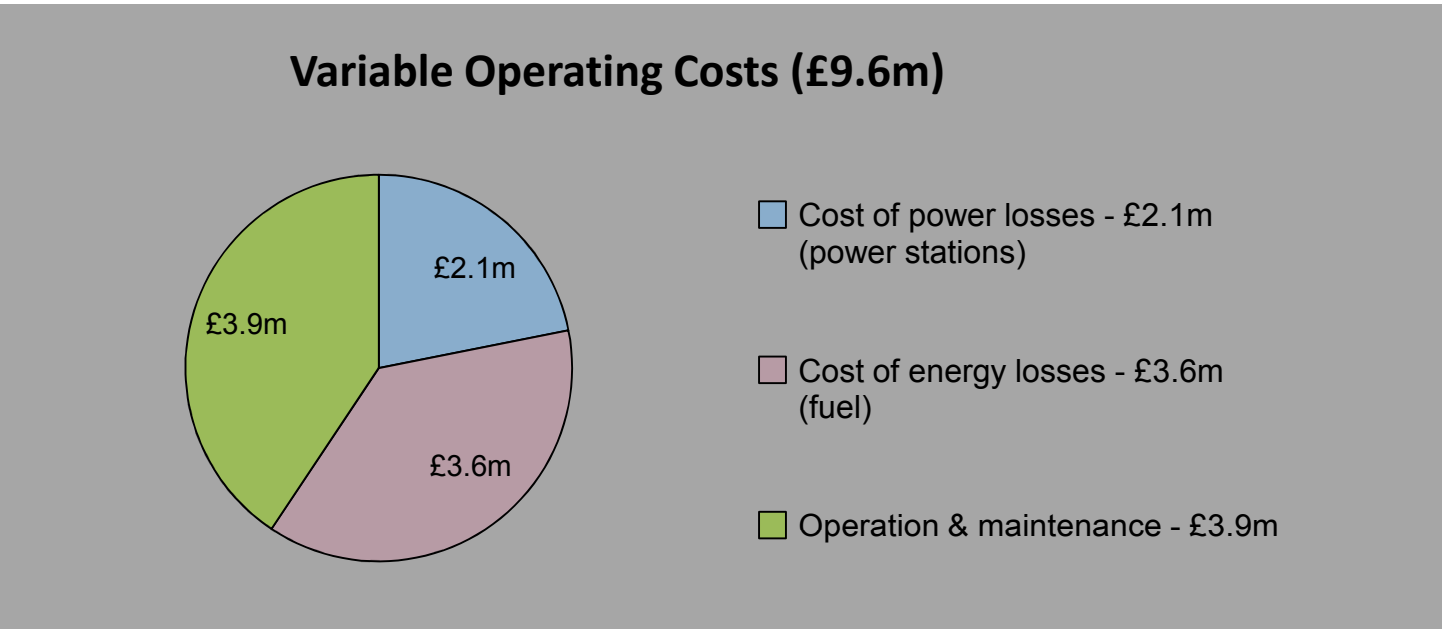
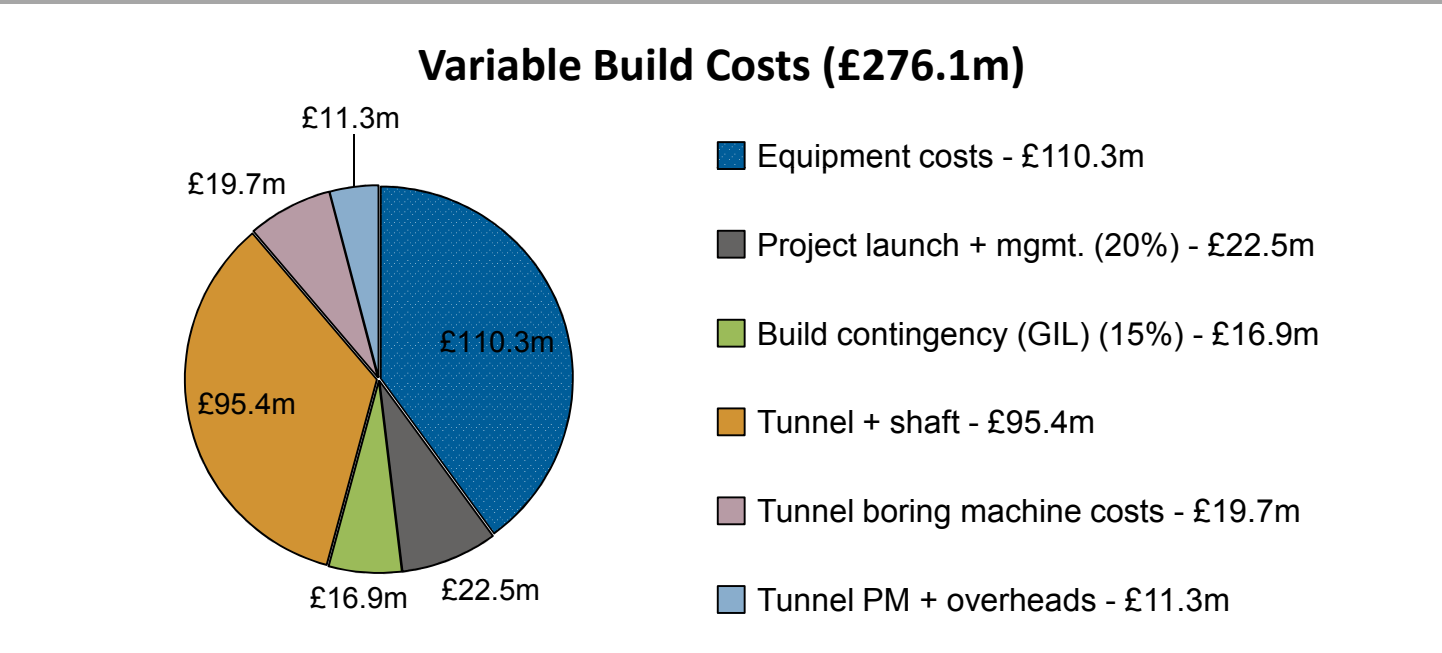
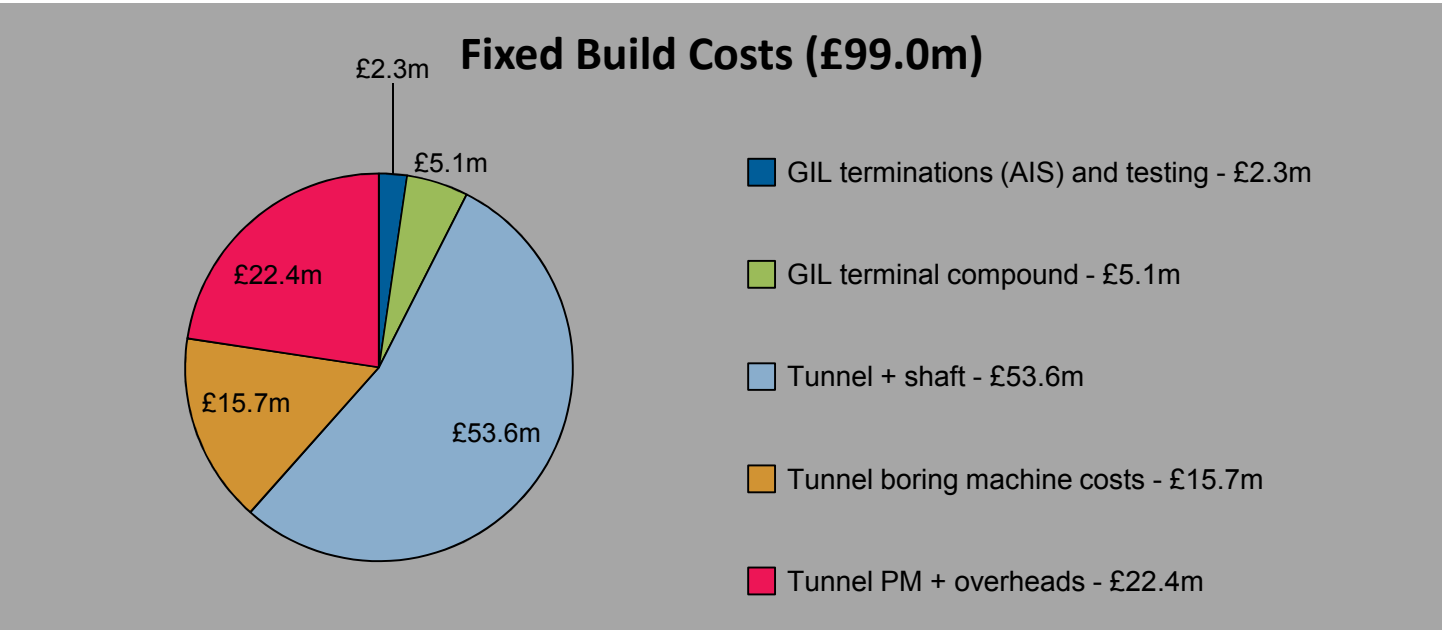

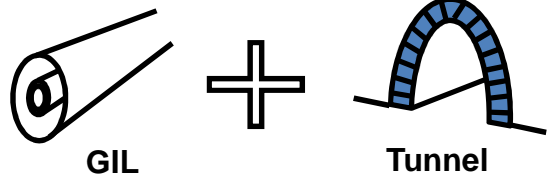

Cost Sensitivities

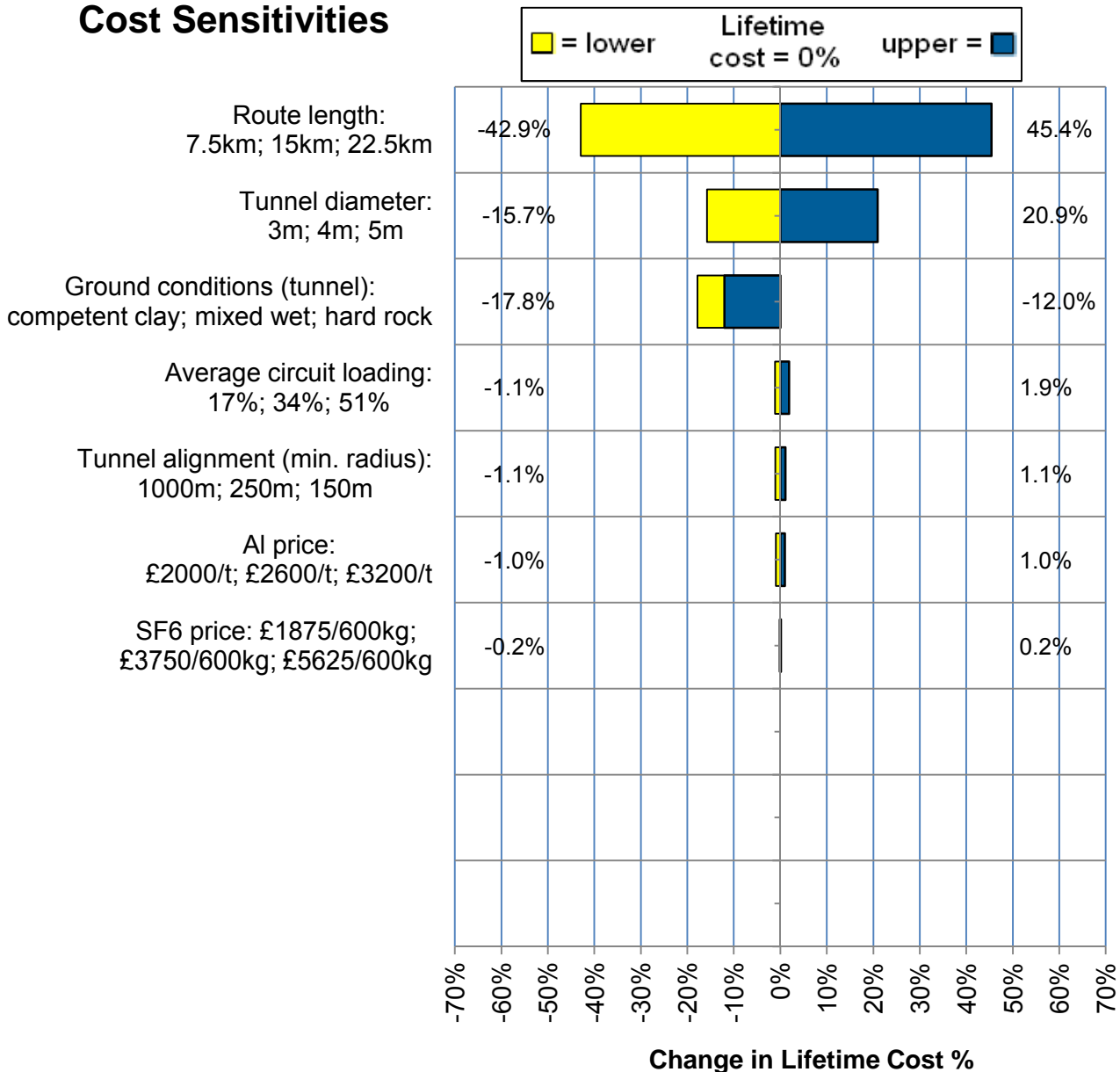

Lifetime Cost Results (£25.7m/km; £8040/MVA-km)

| | |
|----------------------------------|----------------|
| Fixed Build Cost | £99.0m |
| Variable Build Cost | £276.1m |
| Build Cost Total for 15km | £375.1m |
| plus Variable Operating Cost | £9.6m |
| Lifetime Cost for 15km | £384.8m |

| | |
|---|-------------------|
| Lifetime Cost for 15km divided by route length | £384.8m ÷ 15km |
| Lifetime Cost per km | £25.7m/km |

| | |
|---|-------------------------|
| Lifetime Cost per km divided by Power Transfer | £25.7m/km ÷ 3190 MVA |
| Lifetime PTC* per km | £8040/MVA-km |

Other Results

Losses = 1% of Lifetime Cost for 15km

Costs most sensitive to:

- Route length:
-42.9% to 45.4%
- Tunnel diameter:
-15.7% to 20.9%

Notes (Jan-12)

* PTC = Power Transfer Cost

Gas Insulated
Line

Tunnel

AC Gas Insulated Line (tunnel)

15km Route Lifetime Cost: £404m

Med capacity (6380 MVA); 400 kV AC

Fixed Build Costs (£99.0m)

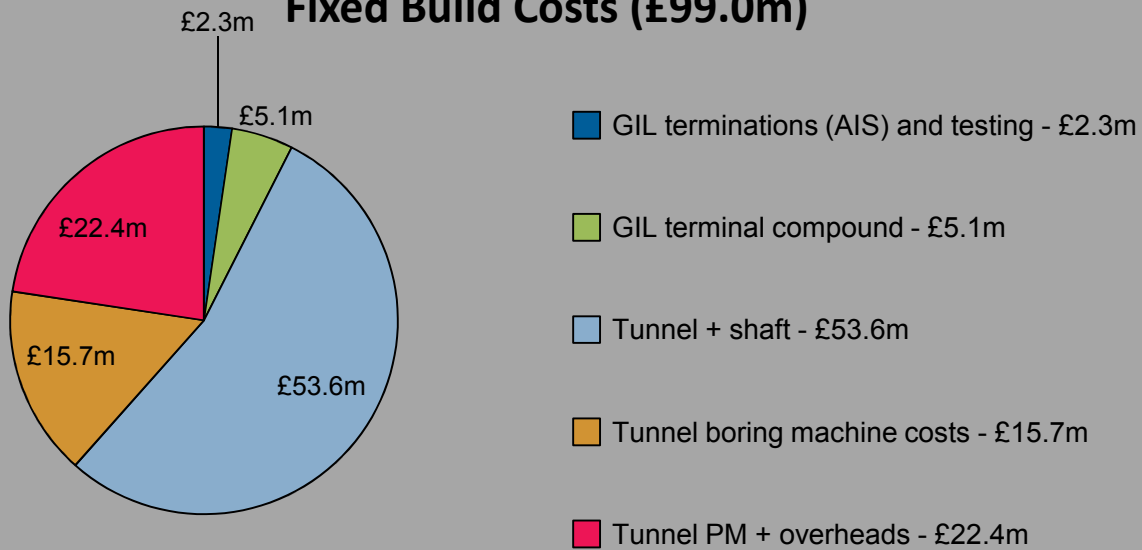

Variable Build Costs (£276.1m)

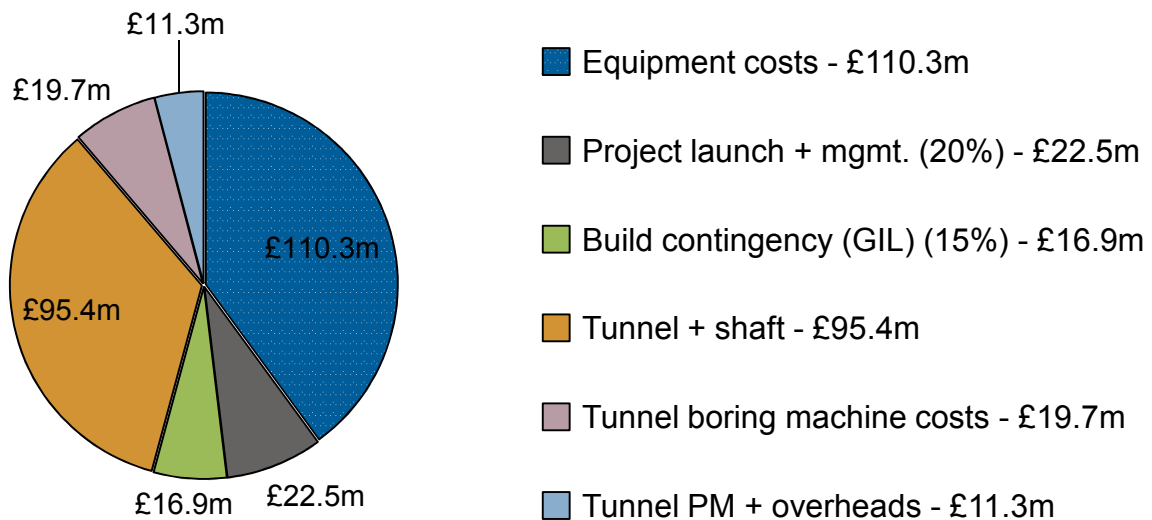

Variable Operating Costs (£28.9m)

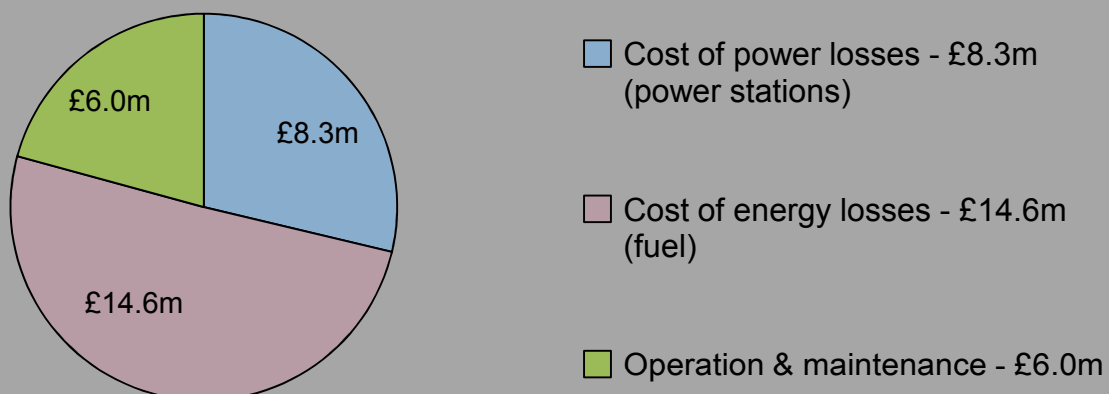

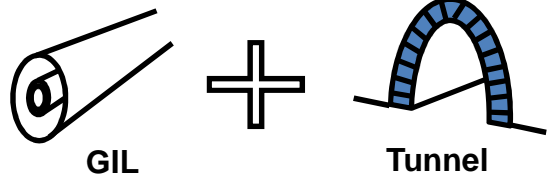

Cost Sensitivities

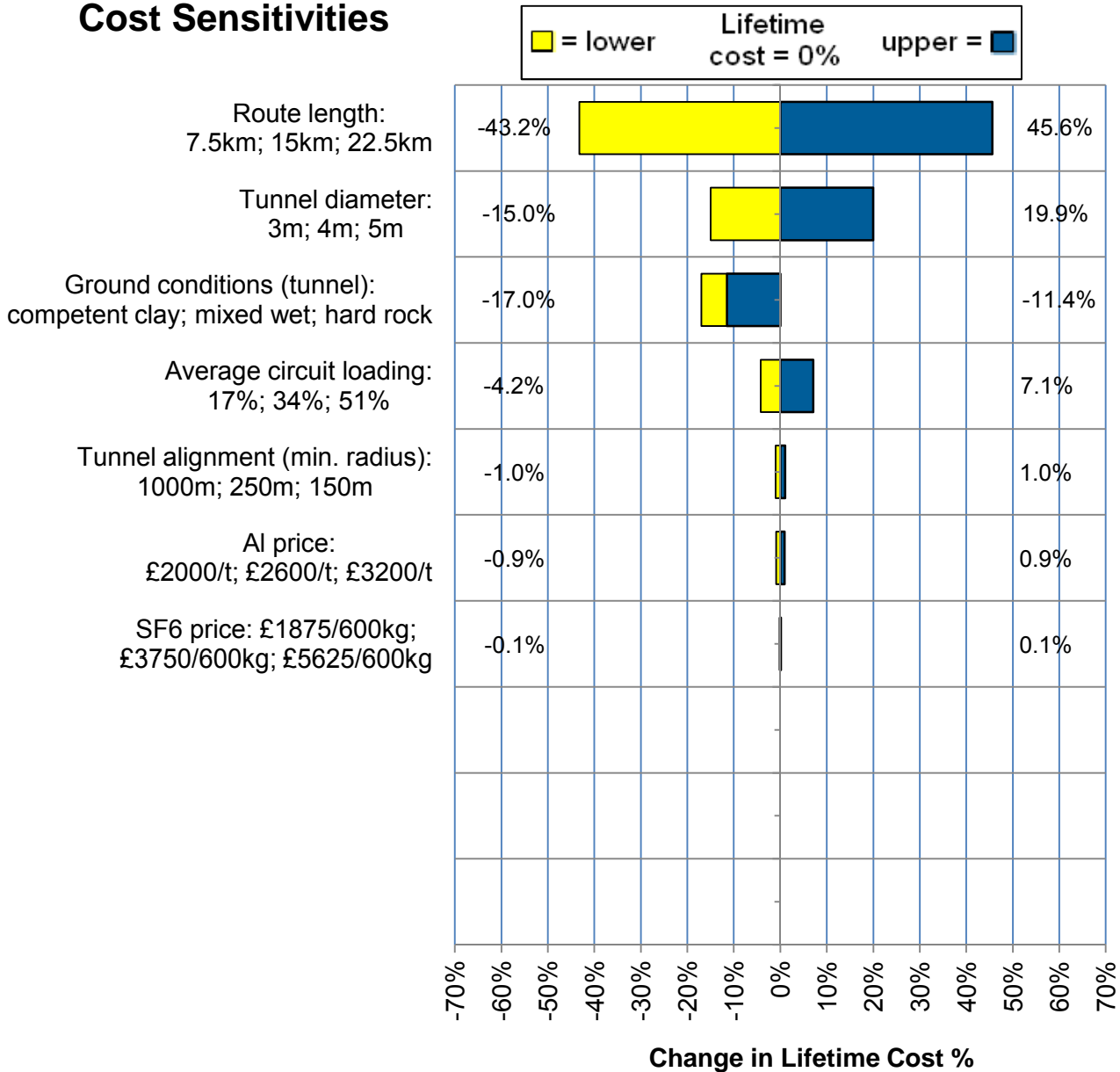

Lifetime Cost Results (£26.9m/km; £4220/MVA-km)

| | |
|----------------------------------|----------------|
| Fixed Build Cost | £99.0m |
| Variable Build Cost | £276.1m |
| Build Cost Total for 15km | £375.1m |
| plus Variable Operating Cost | £28.9m |
| Lifetime Cost for 15km | £404.0m |

| | |
|--|------------------|
| Lifetime Cost for 15km divided by route length | £404.0m ÷ 15km |
| Lifetime Cost per km | £26.9m/km |

| | |
|--|----------------------|
| Lifetime Cost per km divided by Power Transfer | £26.9m/km ÷ 6380 MVA |
| Lifetime PTC* per km | £4220/MVA-km |

Other Results

Losses = 6% of Lifetime Cost for 15km

Costs most sensitive to:

- Route length:
-43.2% to 45.6%
- Tunnel diameter:
-15% to 19.9%

Notes (Jan-12)

* PTC = Power Transfer Cost

Gas Insulated Line

Tunnel

AC Gas Insulated Line (tunnel)

15km Route Lifetime Cost: £408.2m

Hi capacity (6930 MVA); 400 kV AC

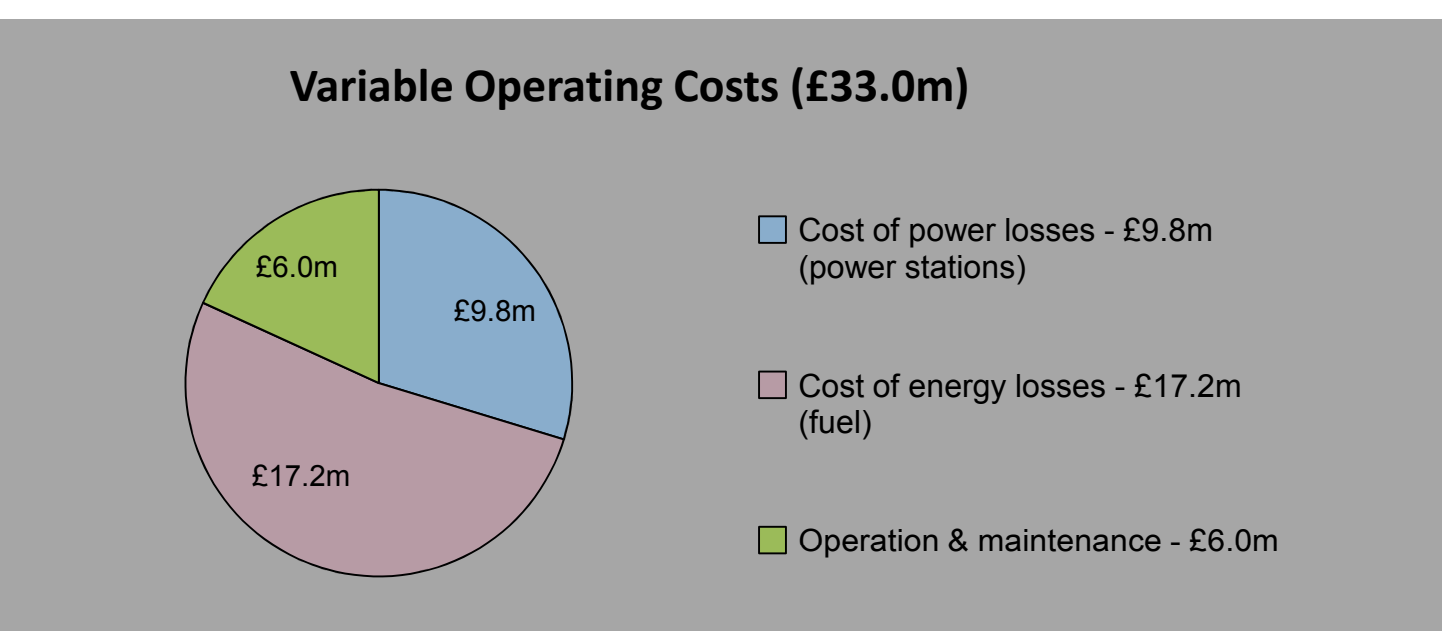
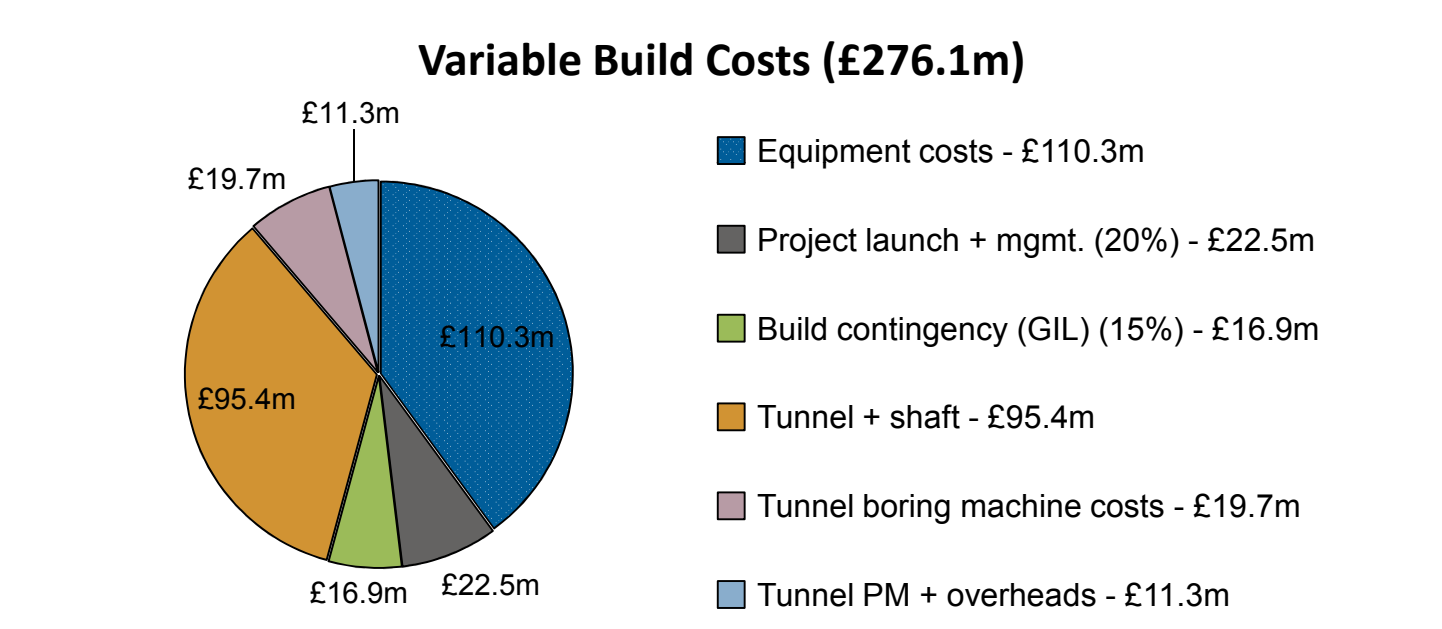
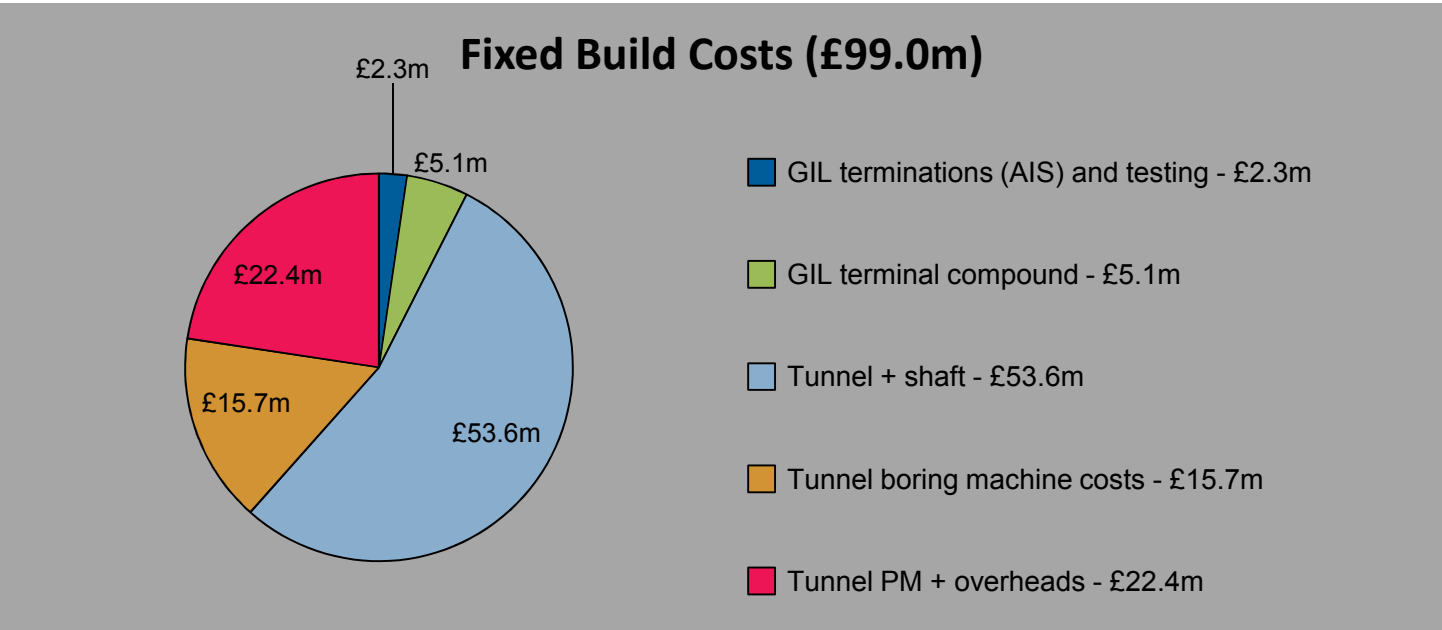

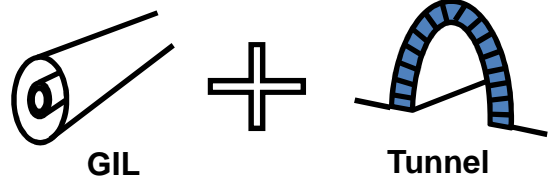

Cost Sensitivities

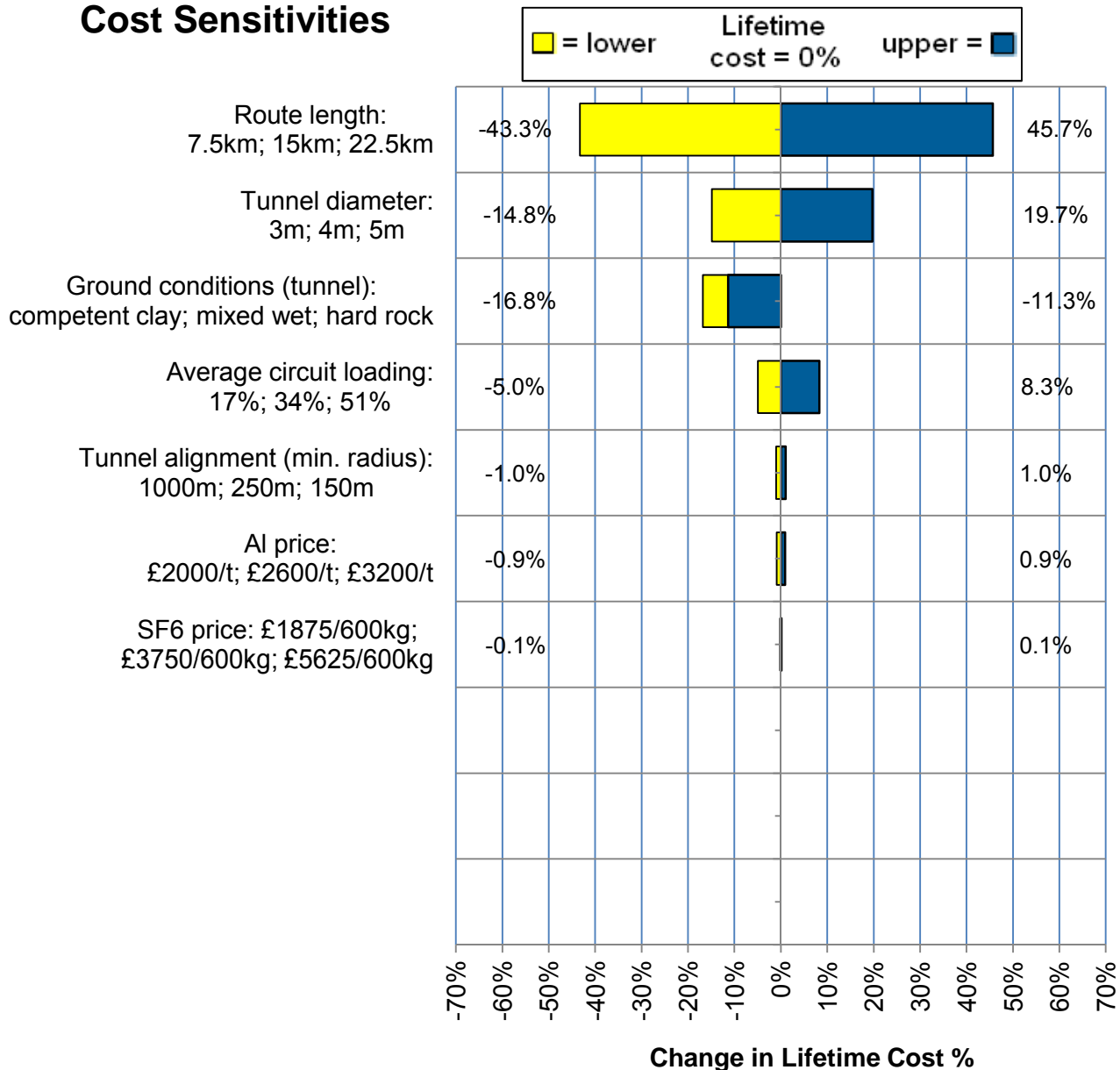

Lifetime Cost Results (£27.2m/km; £3930/MVA-km)

| | |
|----------------------------------|----------------|
| Fixed Build Cost | £99.0m |
| Variable Build Cost | £276.1m |
| Build Cost Total for 15km | £375.1m |
| plus Variable Operating Cost | £33.0m |
| Lifetime Cost for 15km | £408.2m |

| | |
|--|------------------|
| Lifetime Cost for 15km divided by route length | £408.2m ÷ 15km |
| Lifetime Cost per km | £27.2m/km |

| | |
|--|----------------------|
| Lifetime Cost per km divided by Power Transfer | £27.2m/km ÷ 6930 MVA |
| Lifetime PTC* per km | £3930/MVA-km |

Other Results

Losses = 7% of Lifetime Cost for 15km

Costs most sensitive to:

- Route length: -43.3% to 45.7%
- Tunnel diameter: -14.8% to 19.7%

Notes (Jan-12)

* PTC = Power Transfer Cost

Gas Insulated Line

Tunnel

AC Gas Insulated Line (tunnel)

75km Route Lifetime Cost: £1768.2m

Lo capacity (3190 MVA); 400 kV AC

Fixed Build Costs (£278.2m)

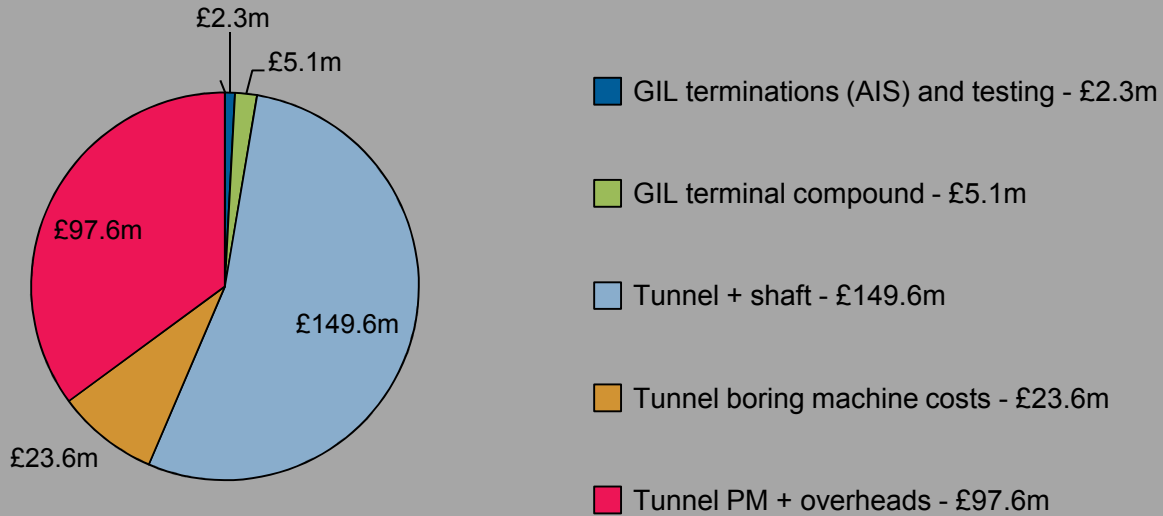

Variable Build Costs (£1441.8m)

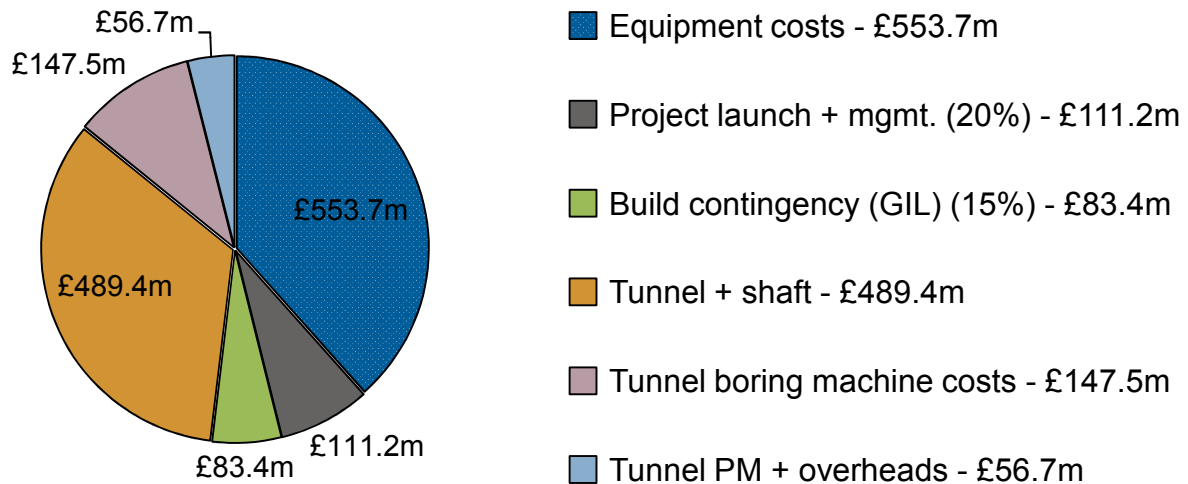

Variable Operating Costs (£48.2m)

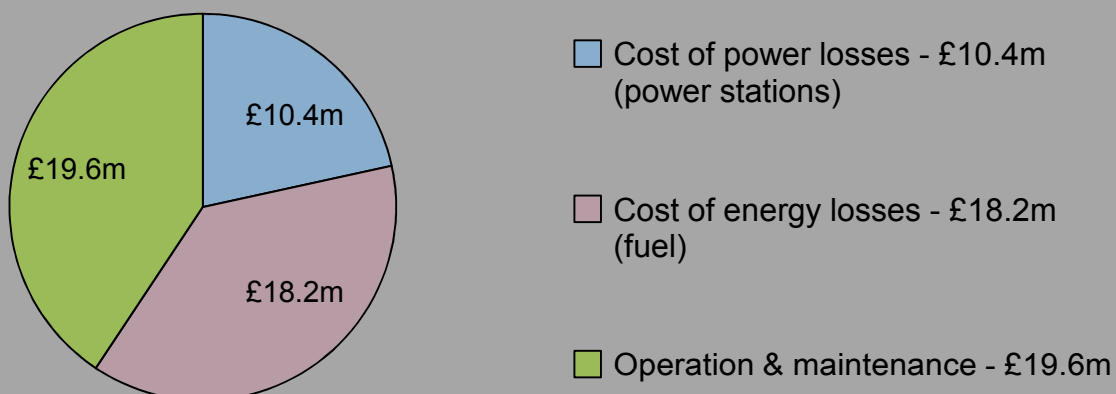

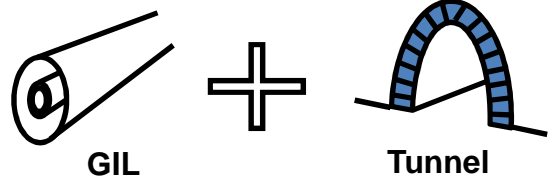

Cost Sensitivities

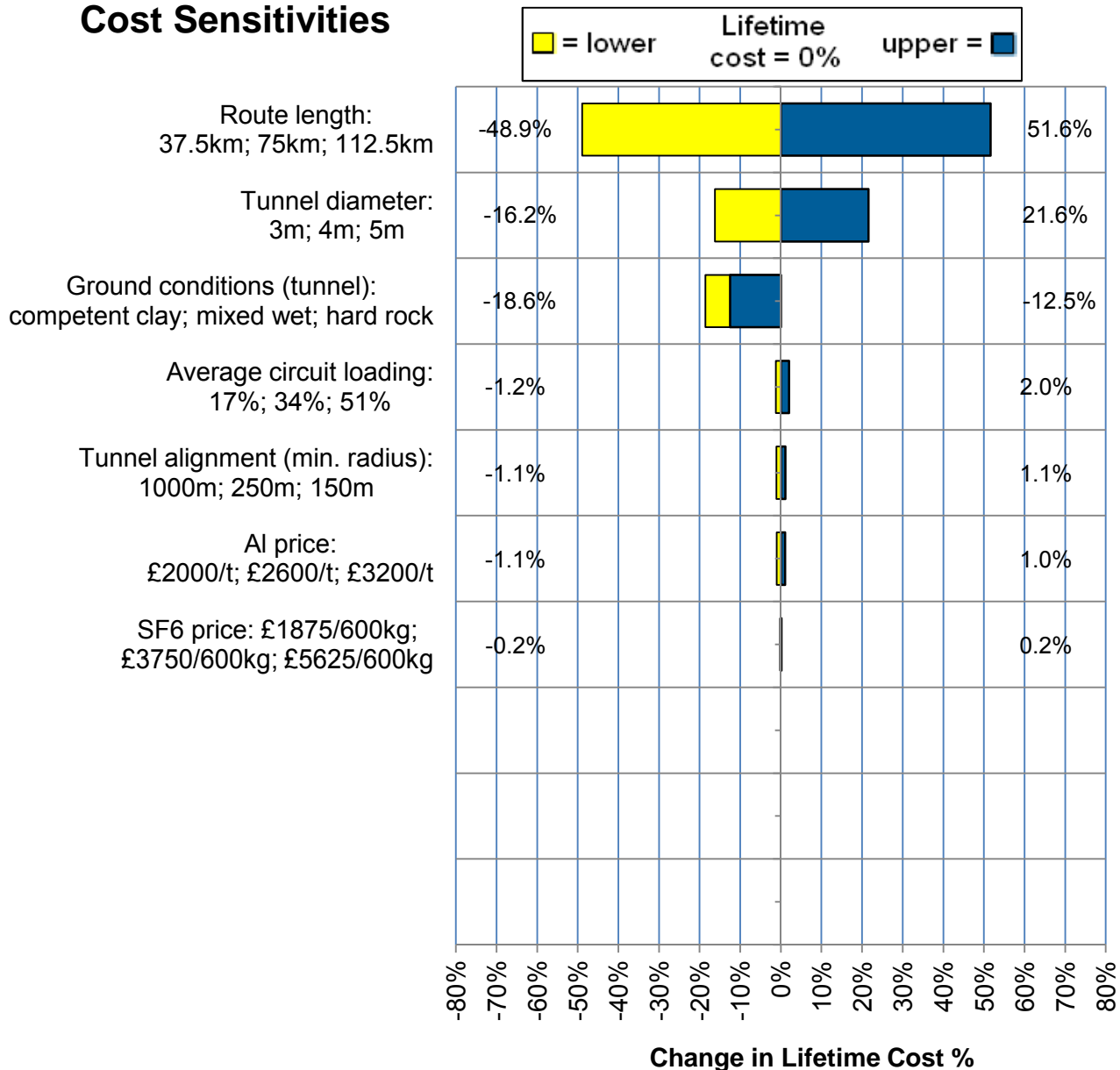

Lifetime Cost Results (£23.6m/km; £7390/MVA-km)

| | |
|----------------------------------|-----------------|
| Fixed Build Cost | £278.2m |
| Variable Build Cost | £1441.8m |
| Build Cost Total for 75km | £1720.0m |
| plus Variable Operating Cost | £48.2m |
| Lifetime Cost for 75km | £1768.2m |

| | |
|---|------------------|
| Lifetime Cost for 75km divided by route length ÷ 75km | £1768.2m |
| Lifetime Cost per km | £23.6m/km |

| | |
|---|---------------------|
| Lifetime Cost per km divided by Power Transfer ÷ 3190 MVA | £23.6m/km |
| Lifetime PTC* per km | £7390/MVA-km |

Other Results

Losses = 2% of Lifetime Cost for 75km

Costs most sensitive to:

- Route length:
-48.9% to 51.6%
- Tunnel diameter:
-16.2% to 21.6%

Notes (Jan-12)

* PTC = Power Transfer Cost

Gas Insulated
Line

Tunnel

AC Gas Insulated Line (tunnel)

75km Route Lifetime Cost: £1864.2m

Med capacity (6380 MVA); 400 kV AC

Fixed Build Costs (£278.2m)

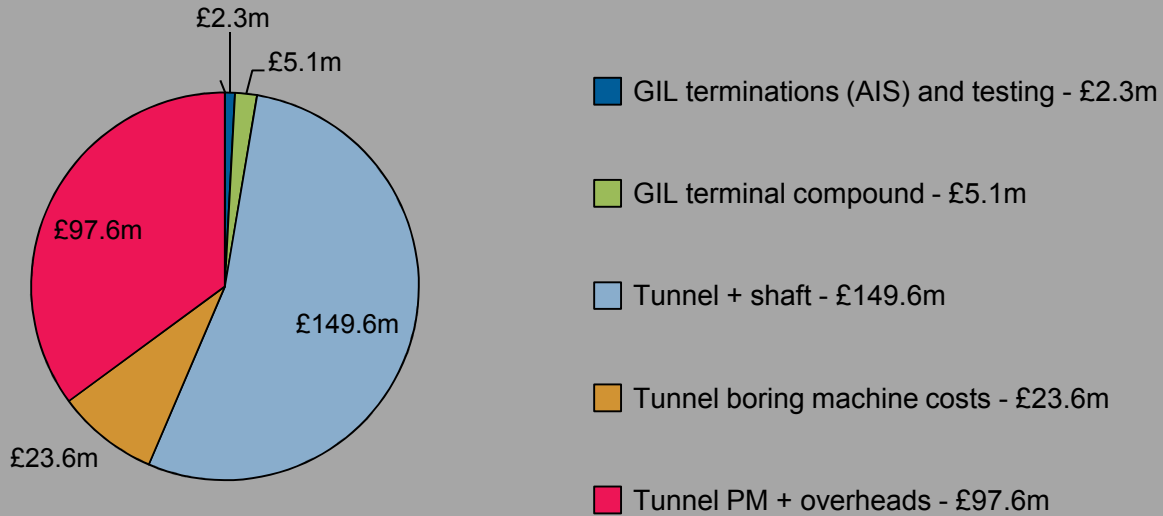

Variable Build Costs (£1441.8m)

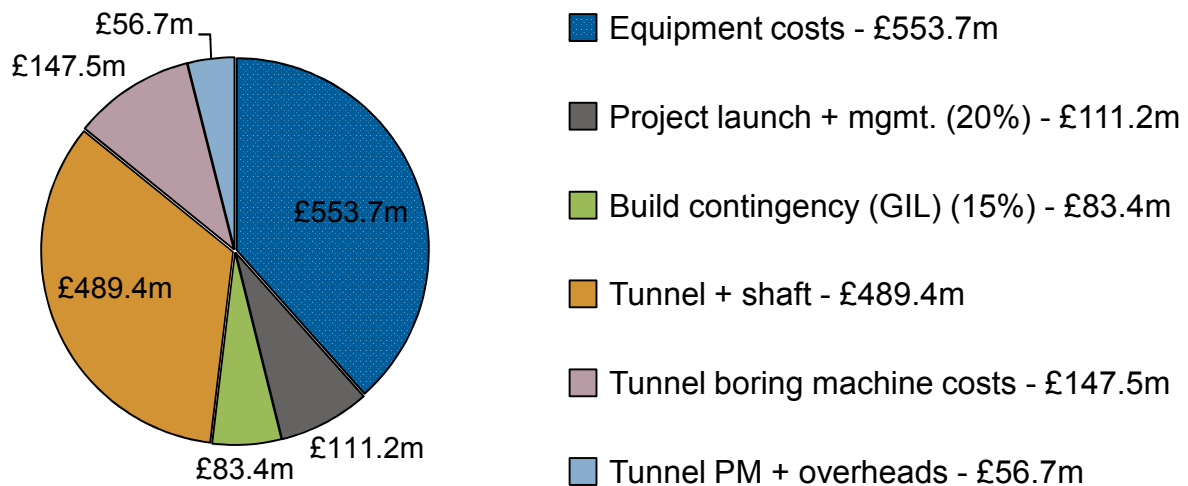

Variable Operating Costs (£144.3m)

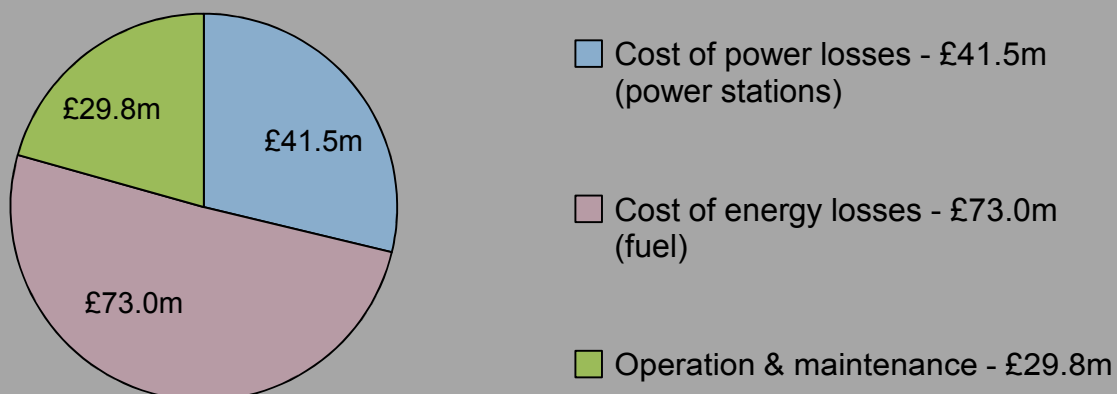

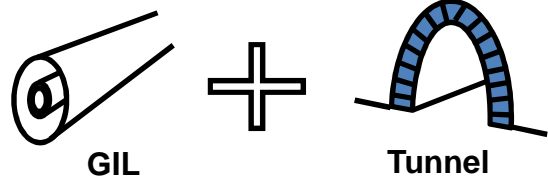

Cost Sensitivities

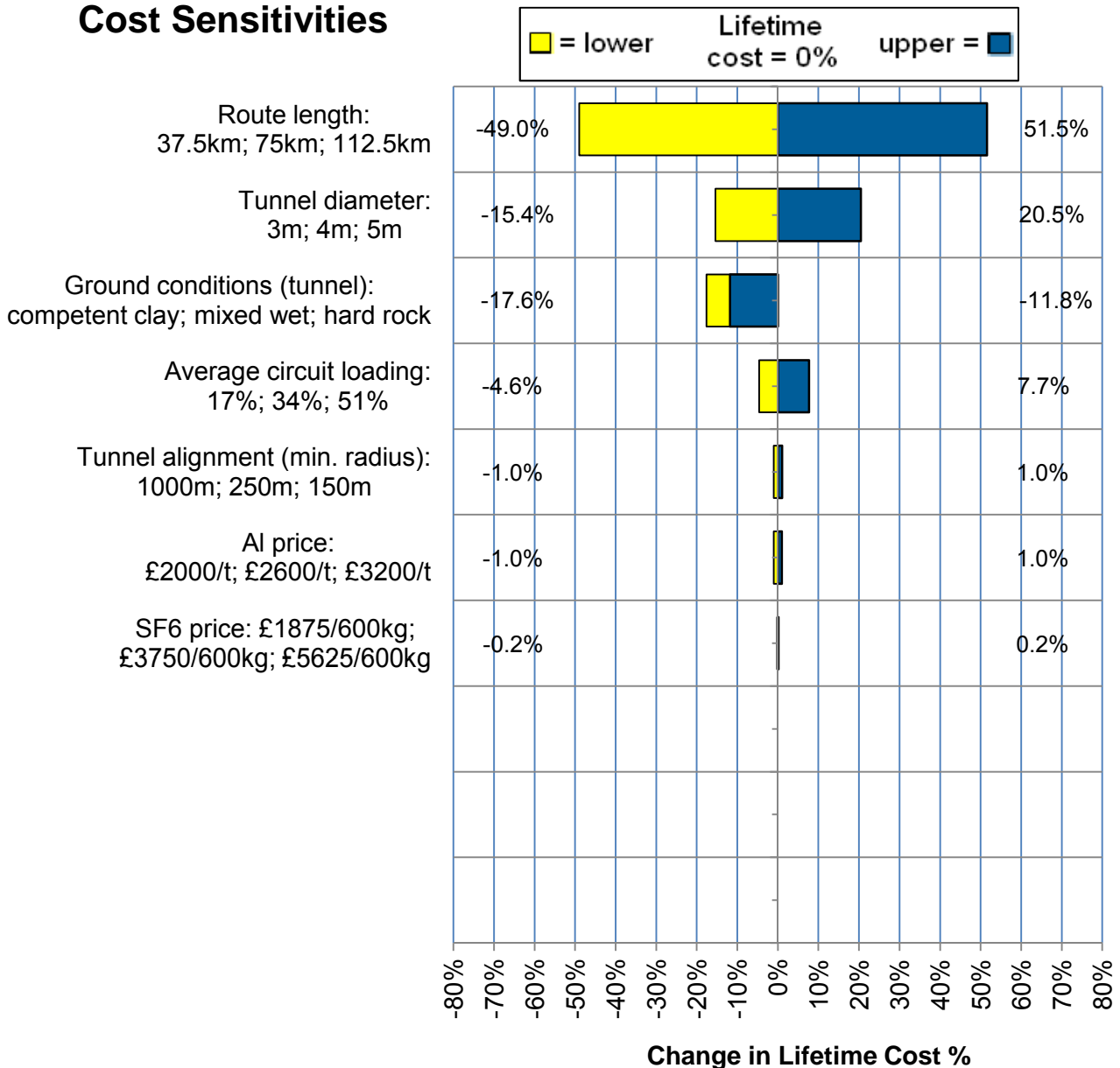

Lifetime Cost Results (£24.9m/km; £3900/MVA-km)

| | |
|----------------------------------|-----------------|
| Fixed Build Cost | £278.2m |
| Variable Build Cost | £1441.8m |
| Build Cost Total for 75km | £1720.0m |
| plus Variable Operating Cost | £144.3m |
| Lifetime Cost for 75km | £1864.2m |

| | |
|---|------------------|
| Lifetime Cost for 75km divided by route length ÷ 75km | £1864.2m |
| Lifetime Cost per km | £24.9m/km |

| | |
|---|---------------------|
| Lifetime Cost per km divided by Power Transfer ÷ 6380 MVA | £24.9m/km |
| Lifetime PTC* per km | £3900/MVA-km |

Other Results

Losses = 6% of Lifetime Cost for 75km

Costs most sensitive to:

- Route length:
-49% to 51.5%
- Tunnel diameter:
-15.4% to 20.5%

Notes (Jan-12)

* PTC = Power Transfer Cost

Gas Insulated
Line

Tunnel

AC Gas Insulated Line (tunnel)

75km Route Lifetime Cost: £1884.8m

Hi capacity (6930 MVA); 400 kV AC

Fixed Build Costs (£278.2m)

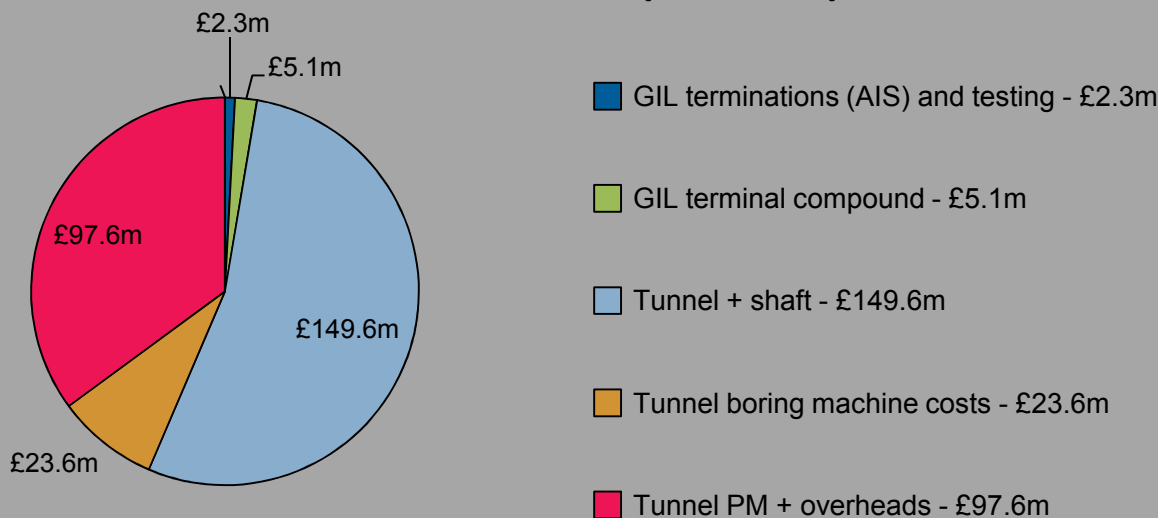

Variable Build Costs (£1441.8m)

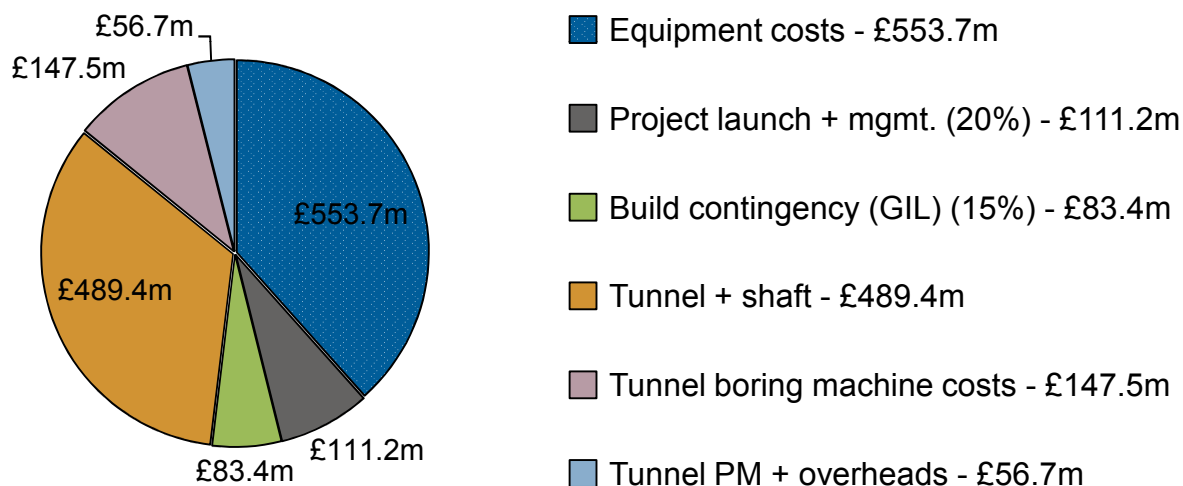

Variable Operating Costs (£164.9m)

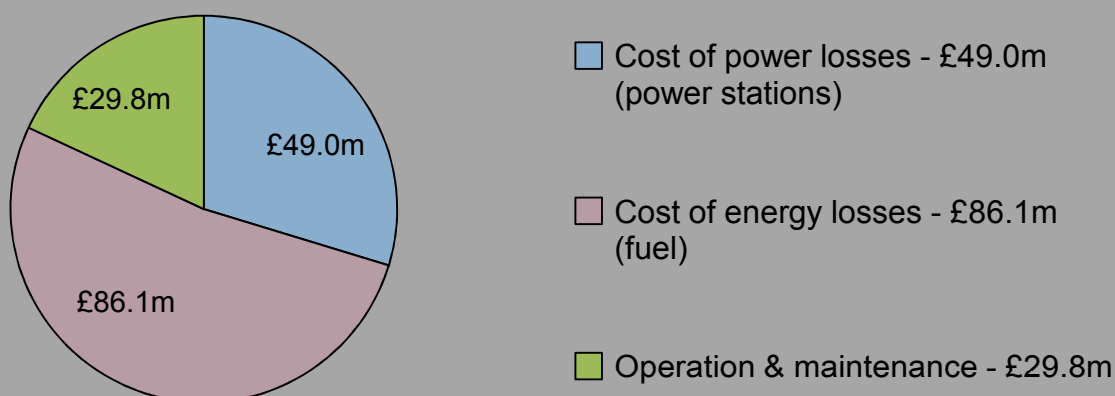

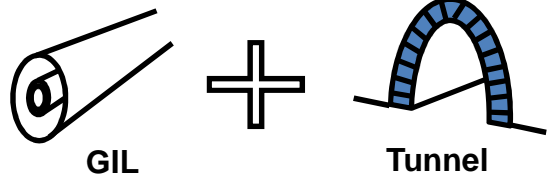

Cost Sensitivities

= lower
 Lifetime cost = 0%
 upper =

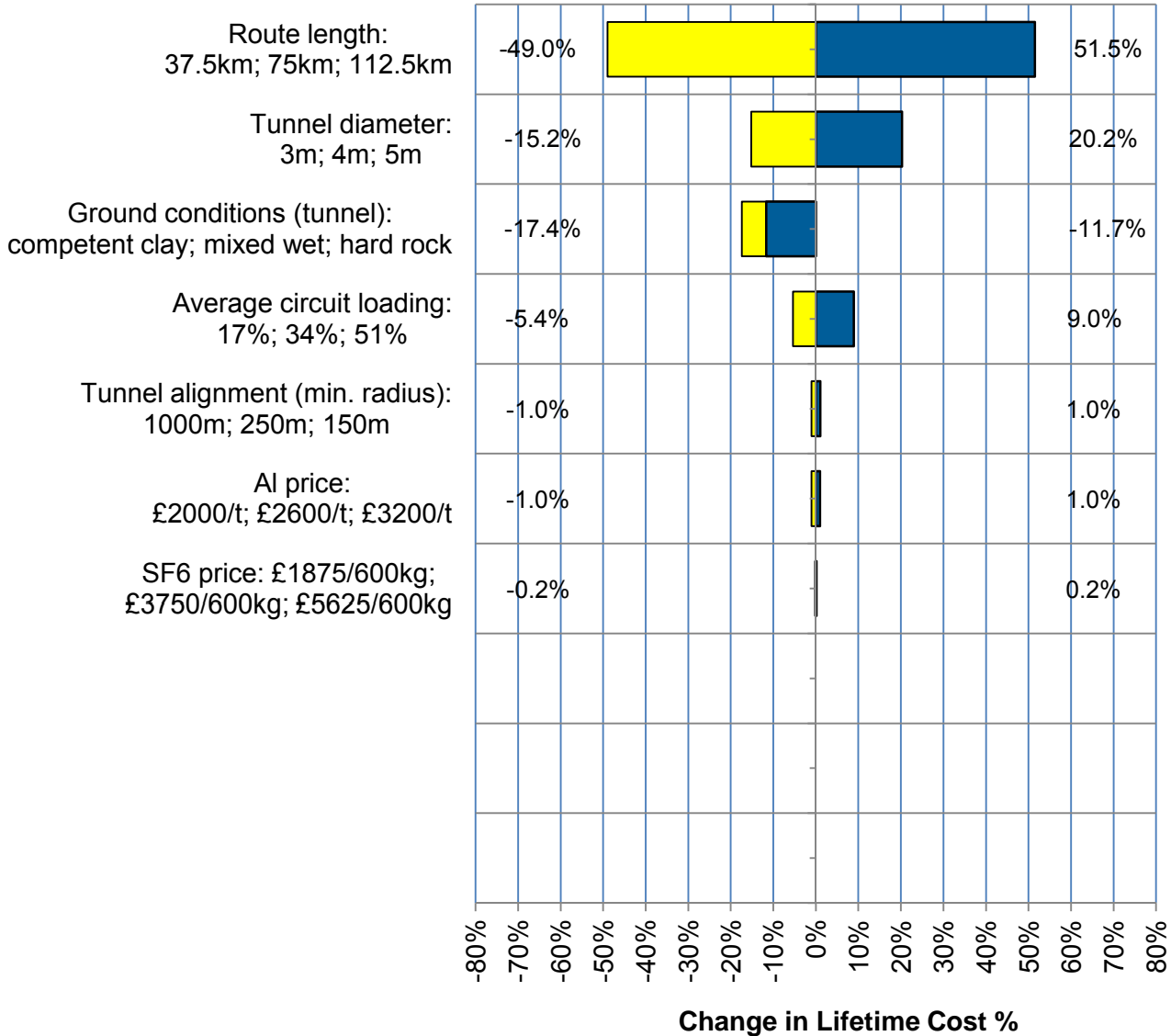

Lifetime Cost Results (£25.1m/km; £3630/MVA-km)

| | |
|----------------------------------|-----------------|
| Fixed Build Cost | £278.2m |
| Variable Build Cost | £1441.8m |
| Build Cost Total for 75km | £1720.0m |
| plus Variable Operating Cost | £164.9m |
| Lifetime Cost for 75km | £1884.8m |

| | |
|--|------------------|
| Lifetime Cost for 75km divided by route length | £1884.8m ÷ 75km |
| Lifetime Cost per km | £25.1m/km |

| | |
|--|----------------------|
| Lifetime Cost per km divided by Power Transfer | £25.1m/km ÷ 6930 MVA |
| Lifetime PTC* per km | £3630/MVA-km |

Other Results

Losses = 7% of Lifetime Cost for 75km

Costs most sensitive to:

- Route length: -49% to 51.5%
- Tunnel diameter: -15.2% to 20.2%

Notes (Jan-12)

* PTC = Power Transfer Cost

Gas Insulated Line

Tunnel

Cost charts for HVDC subsea cable

The following charts present the lifetime cost make-up and associated sensitivities on lifetime cost for the HVDC subsea cable electricity transmission options.

Figure 5 – Ballycronan More 500MW CSC converter station



(Photo courtesy of Siemens)

DC Subsea Cable (LCC)

75km Route Lifetime Cost: £1002m

Lo capacity (3000 MW); ±400kV DC (LCC)

Fixed Build Costs (£557.5m)

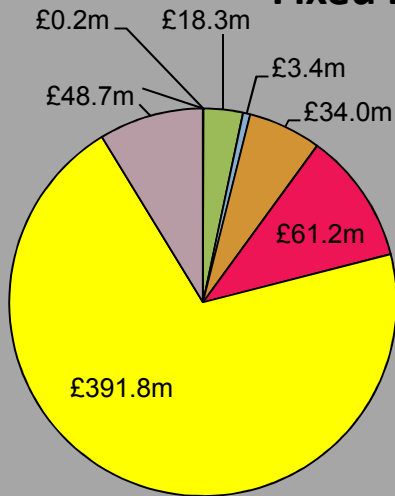

- Cable studies and assessments - £0.2m
- Cable landing costs and materials - £18.3m
- Cable mobilisation/demob. costs - £3.4m
- Converter project launch + mgmt. - £34.0m
- Converter EPC contract cost (GBP costs) - £61.2m
- Converter EPC contract cost (EUR costs) - £391.8m
- Converter build contingency (10%) - £48.7m

Variable Build Costs (£181.6m)

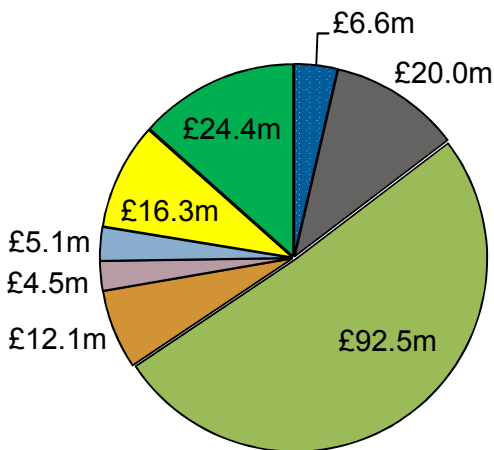

- Cable contractor PM - £6.6m
- Cable studies and assessments - £20.0m
- Cable materials & installation - £92.5m
- Bad weather allowance (cable) - £12.1m
- Marine insurance (cable) - £4.5m
- Cable subsea service crossings - £5.1m
- Cable project launch + mgmt. (10%) - £16.3m
- Cable system build contingency (15%) - £24.4m

Variable Operating Costs (£262.9m)

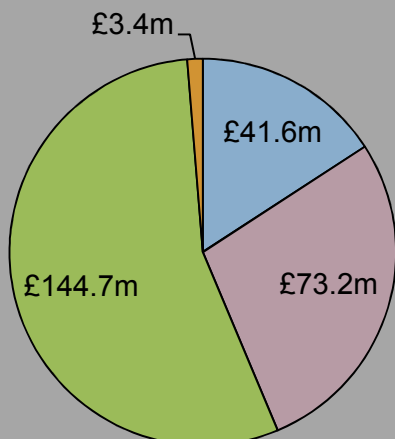

- Combined cost of power losses (power stations) - £41.6m
- Combined cost of energy losses (fuel) - £73.2m
- Combined operation & maintenance - £144.7m
- Converter refurbishment - £3.4m

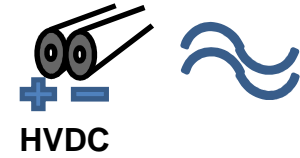

Cost Sensitivities

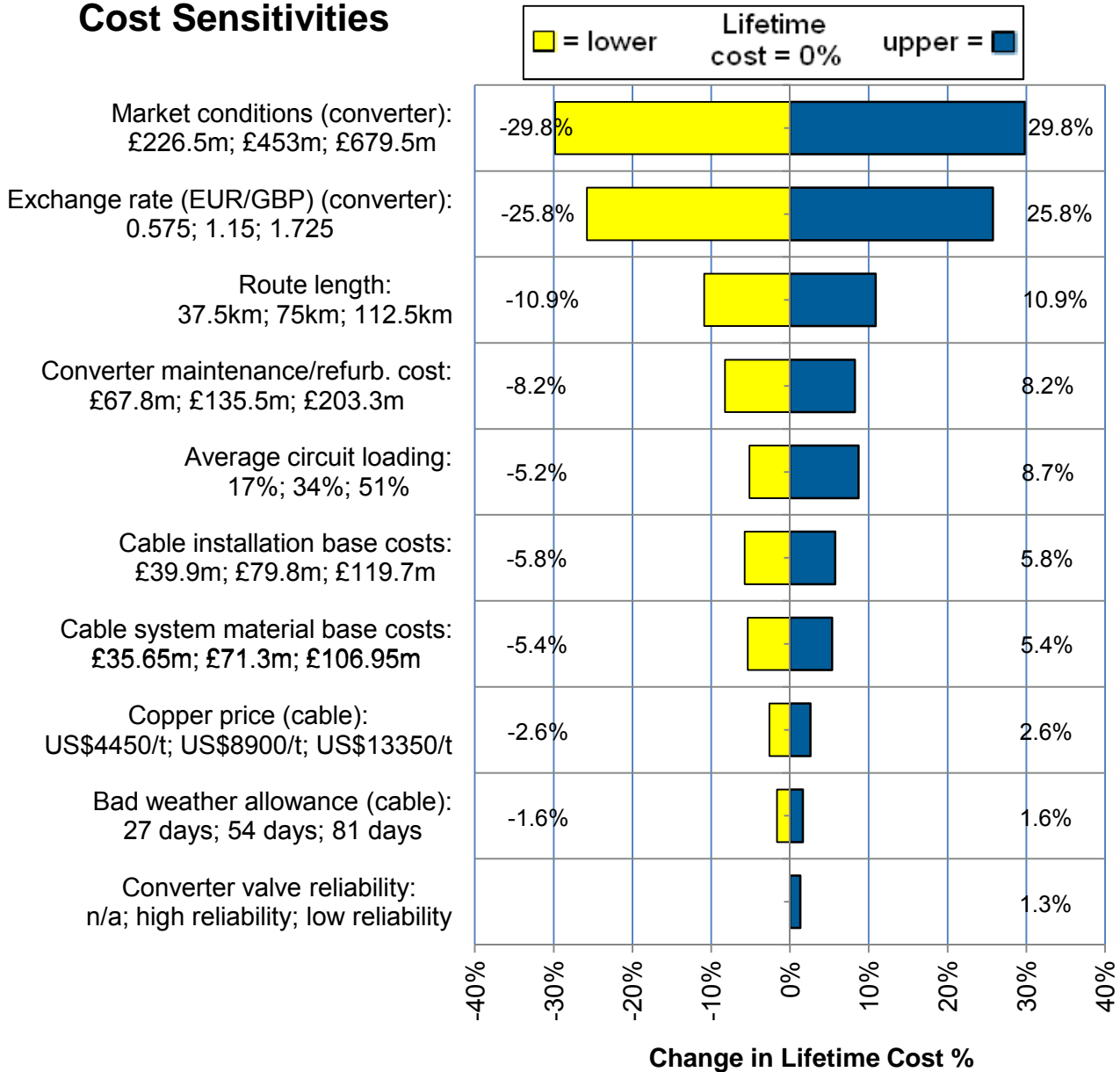

Subsea cable
HVDC converters

Lifetime Cost Results (£13.4m/km; £2230/MW-km)

| | |
|--|--------------------|
| Fixed Build Cost | £557.5m |
| Variable Build Cost | £181.6m |
| Build Cost Total for 75km | £739.1m |
| plus Variable Operating Cost | £262.9m |
| Lifetime Cost for 75km | £1002.0m |
| ↓ | |
| Lifetime Cost for 75km divided by route length ÷ 75km | £1002.0m |
| Lifetime Cost per km | £13.4m/km |
| ↓ | |
| Lifetime Cost per km divided by Power Transfer ÷ 3000 MW | £13.4m/km |
| Lifetime PTC* per km | £2230/MW-km |

Other Results
Losses = 11% of Lifetime Cost for 75km

Costs most sensitive to:

- Market conditions (converter):
-29.8% to 29.8%
- Exchange rate (EUR/GBP) (converter):
-25.8% to 25.8%

Notes (Jan-12)

* PTC = Power Transfer Cost

DC Subsea Cable (LCC)

75km Route Lifetime Cost: £1644.1m

Med capacity (6000 MW); ±400kV DC (LCC)

Fixed Build Costs (£837.1m)

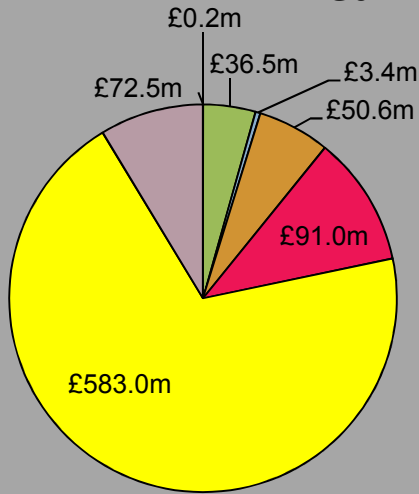

- Cable studies and assessments - £0.2m
- Cable landing costs and materials - £36.5m
- Cable mobilisation/demob. costs - £3.4m
- Converter project launch + mgmt. - £50.6m
- Converter EPC contract cost (GBP costs) - £91.0m
- Converter EPC contract cost (EUR costs) - £583.0m
- Converter build contingency (10%) - £72.5m

Variable Build Costs (£358.8m)

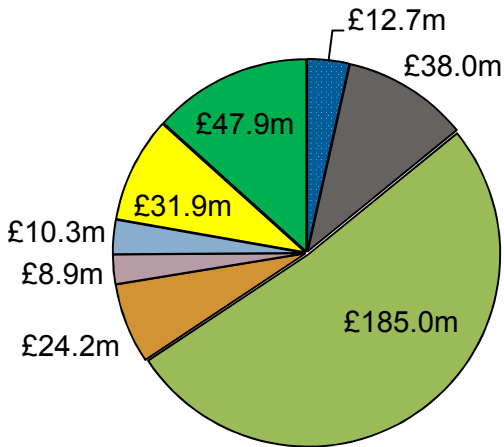

- Cable contractor PM - £12.7m
- Cable studies and assessments - £38.0m
- Cable materials & installation - £185.0m
- Bad weather allowance (cable) - £24.2m
- Marine insurance (cable) - £8.9m
- Cable subsea service crossings - £10.3m
- Cable project launch + mgmt. (10%) - £31.9m
- Cable system build contingency (15%) - £47.9m

Variable Operating Costs (£448.2m)

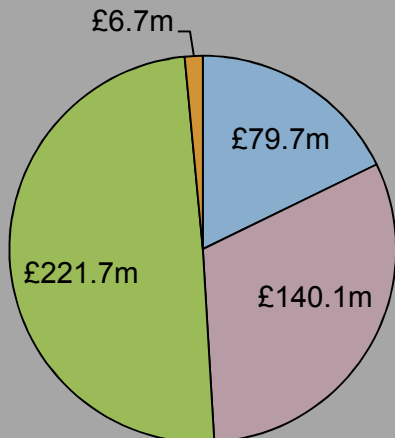

- Combined cost of power losses (power stations) - £79.7m
- Combined cost of energy losses (fuel) - £140.1m
- Combined operation & maintenance - £221.7m
- Converter refurbishment - £6.7m

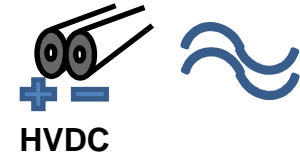

Cost Sensitivities

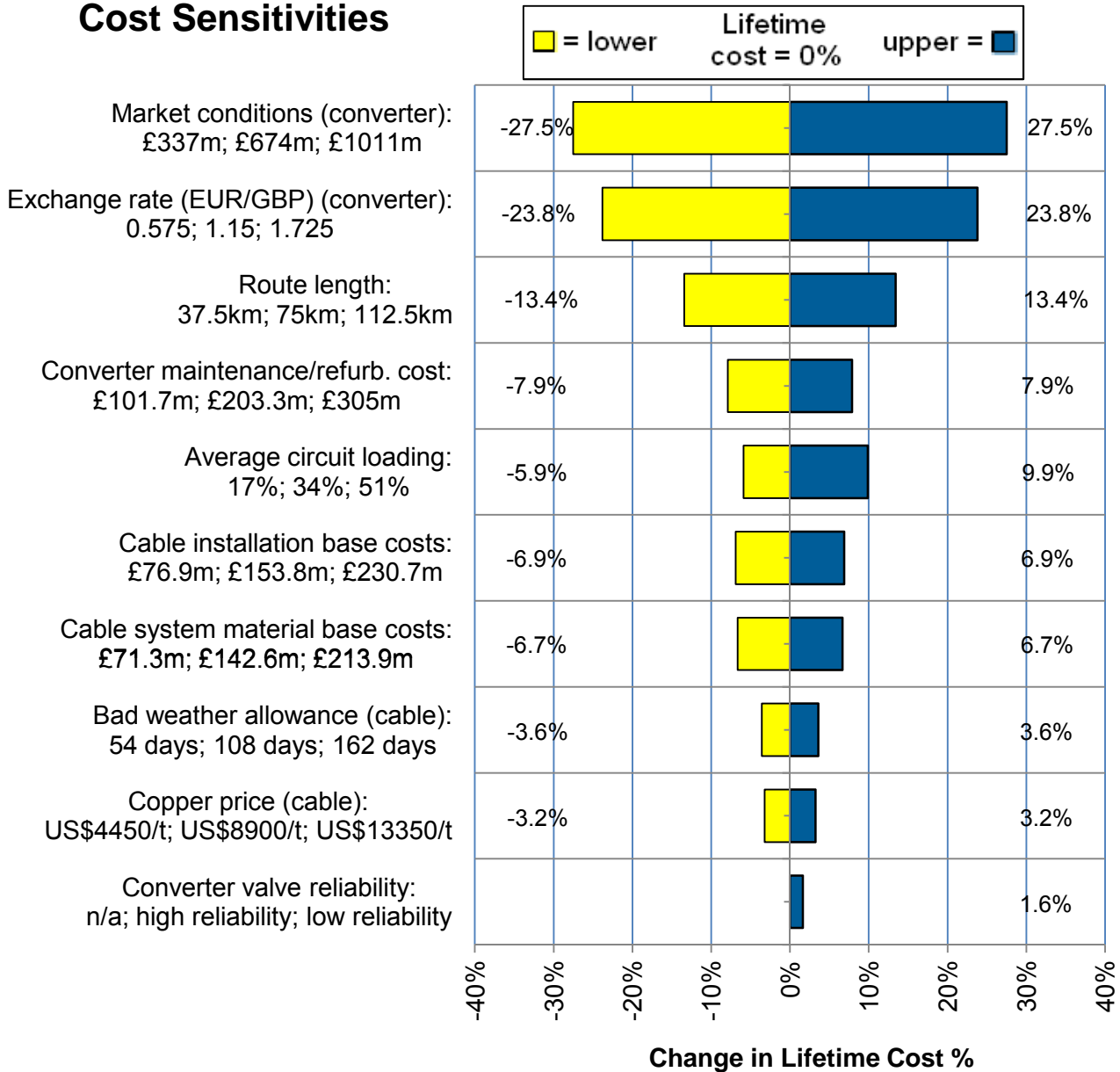

Subsea cable
HVDC converters

Lifetime Cost Results (£21.9m/km; £1830/MW-km)

| | |
|--|--------------------|
| Fixed Build Cost | £837.1m |
| Variable Build Cost | £358.8m |
| Build Cost Total for 75km | £1195.9m |
| plus Variable Operating Cost | £448.2m |
| Lifetime Cost for 75km | £1644.1m |
| ↓ | |
| Lifetime Cost for 75km divided by route length ÷ 75km | £1644.1m |
| Lifetime Cost per km | £21.9m/km |
| ↓ | |
| Lifetime Cost per km divided by Power Transfer ÷ 6000 MW | £21.9m/km |
| Lifetime PTC* per km | £1830/MW-km |

Other Results
Losses = 13% of Lifetime Cost for 75km

Costs most sensitive to:

- Market conditions (converter):
-27.5% to 27.5%
- Exchange rate (EUR/GBP) (converter):
-23.8% to 23.8%

Notes (Jan-12)

* PTC = Power Transfer Cost

DC Subsea Cable (VSC)

75km Route Lifetime Cost: £1229m

Lo capacity (3000 MW); ±320kV DC (VSC)

Fixed Build Costs (£717.9m)

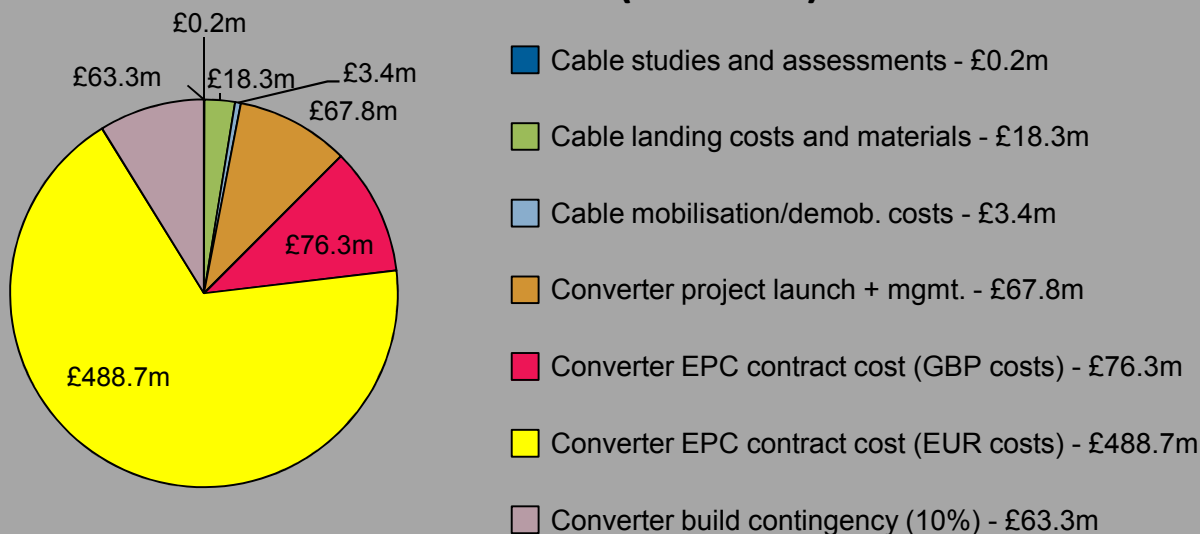

Variable Build Costs (£185.9m)

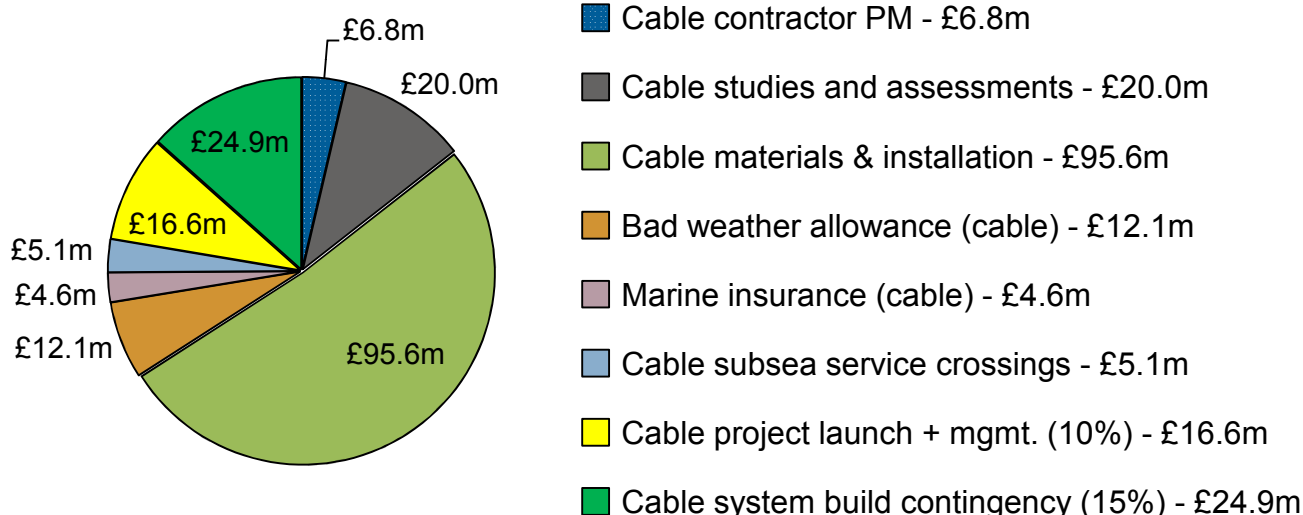

Variable Operating Costs (£325.1m)

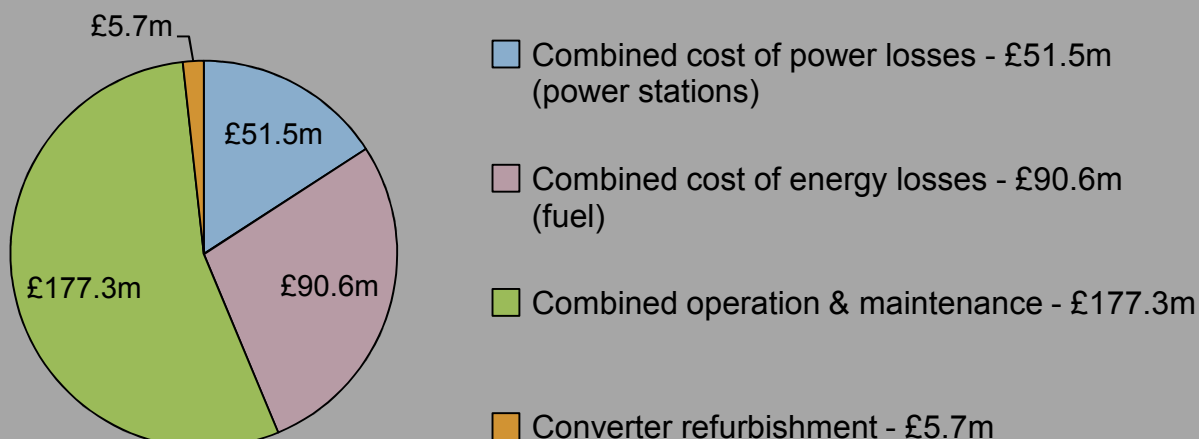

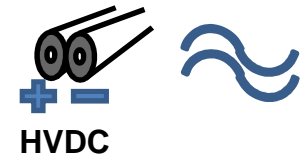

Cost Sensitivities

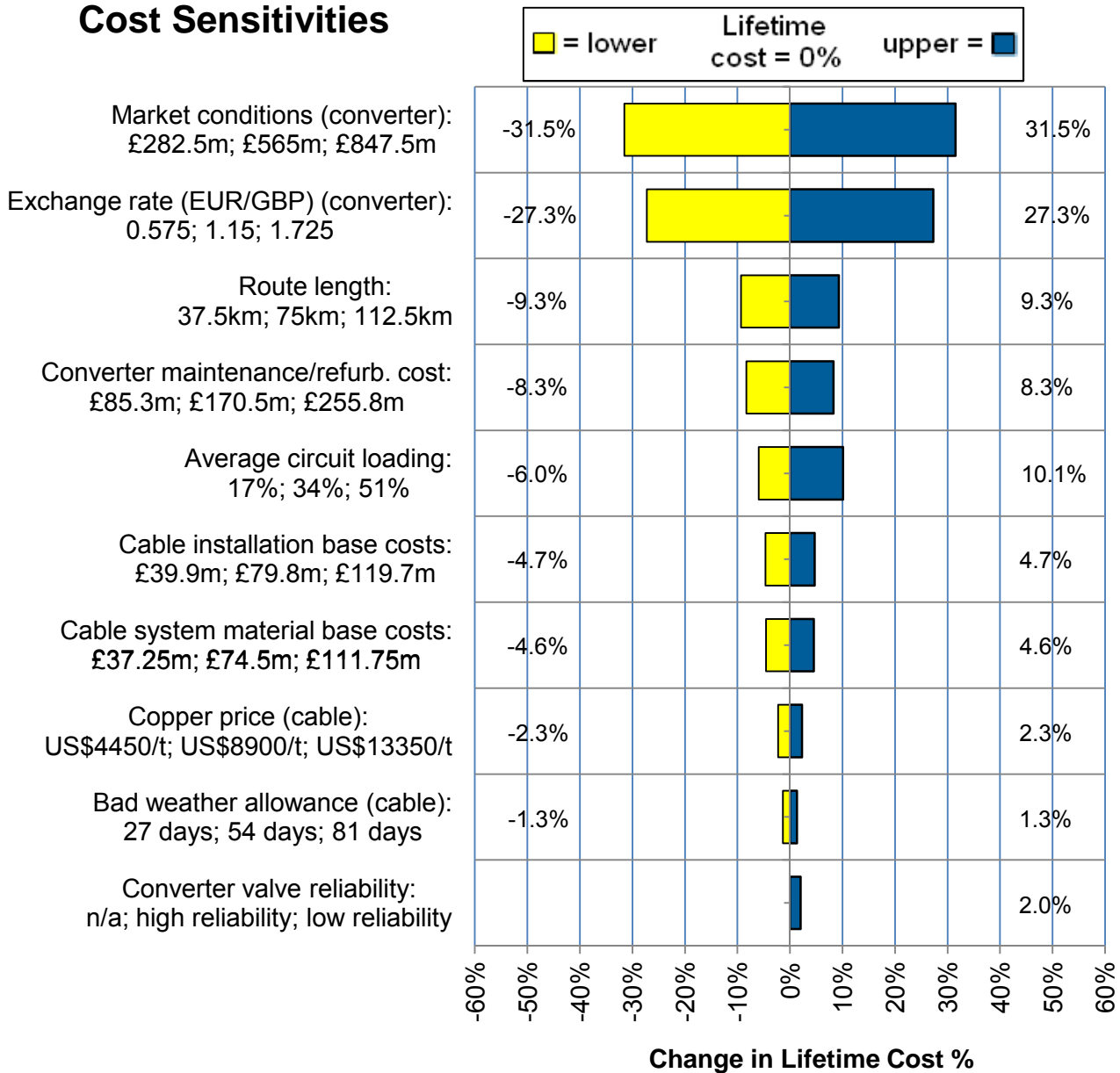

Subsea cable
HVDC converters

Lifetime Cost Results (£16.4m/km; £2730/MW-km)

| | |
|--|--------------------|
| Fixed Build Cost | £717.9m |
| Variable Build Cost | £185.9m |
| Build Cost Total for 75km | £903.8m |
| plus Variable Operating Cost | £325.1m |
| Lifetime Cost for 75km | £1229.0m |
| ↓ | |
| Lifetime Cost for 75km divided by route length ÷ 75km | £1229.0m |
| Lifetime Cost per km | £16.4m/km |
| ↓ | |
| Lifetime Cost per km divided by Power Transfer ÷ 3000 MW | £16.4m/km |
| Lifetime PTC* per km | £2730/MW-km |

| |
|---|
| Other Results |
| Losses = 12% of Lifetime Cost for 75km |
| Costs most sensitive to: |
| • Market conditions (converter): -31.5% to 31.5% |
| • Exchange rate (EUR/GBP) (converter): -27.3% to 27.3% |

| |
|-----------------------------|
| Notes (Jan-12) |
| * PTC = Power Transfer Cost |

DC Subsea Cable (VSC)

75km Route Lifetime Cost: £2386.6m

Med capacity (6000 MW); ±320kV DC (VSC)

Fixed Build Costs (£1376.3m)

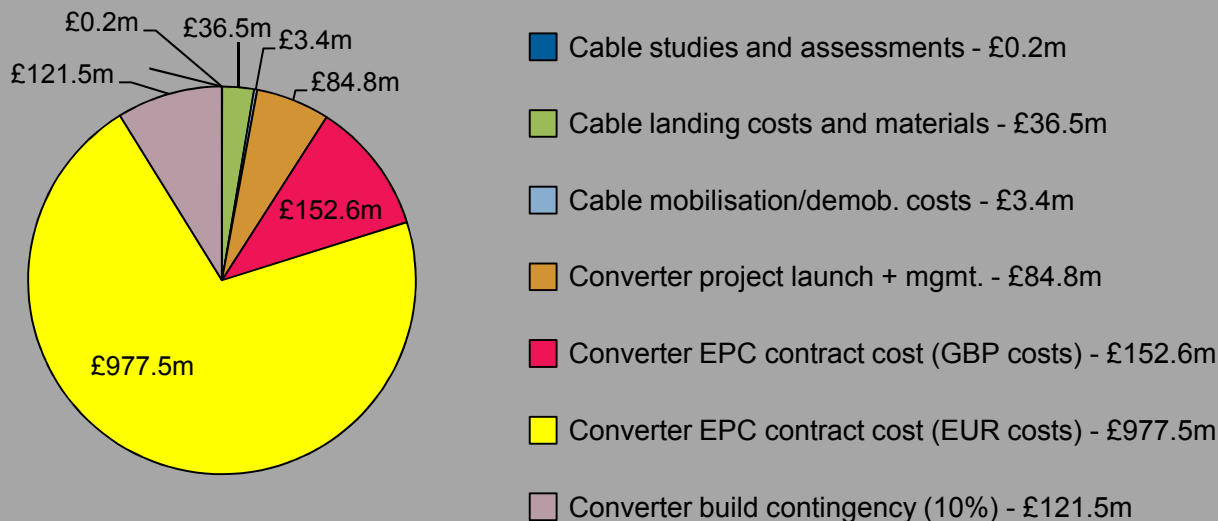

Variable Build Costs (£367.3m)

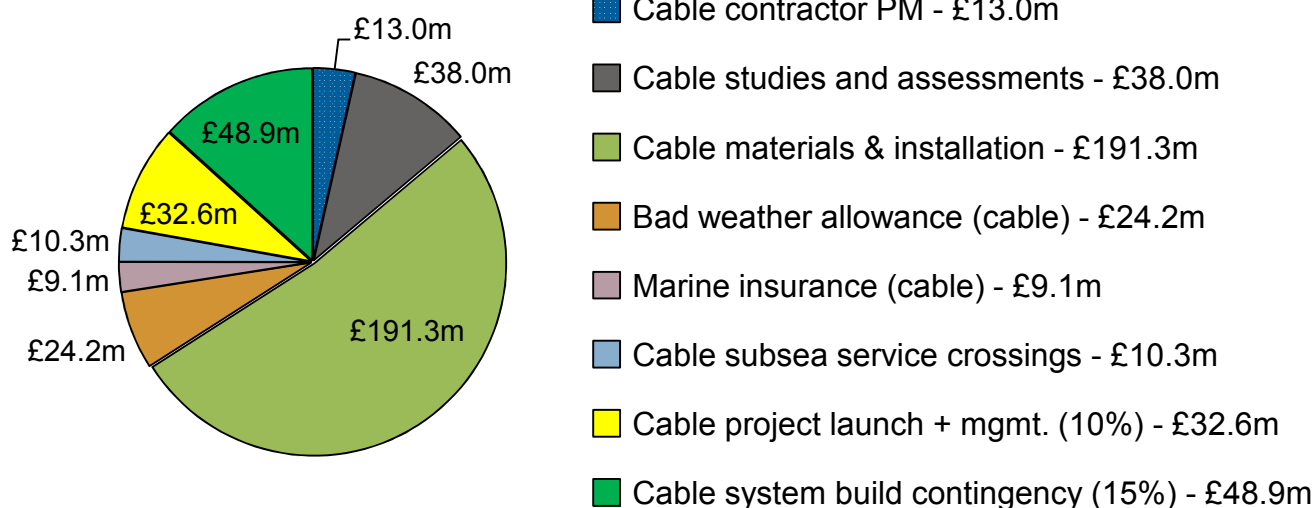

Variable Operating Costs (£643.0m)

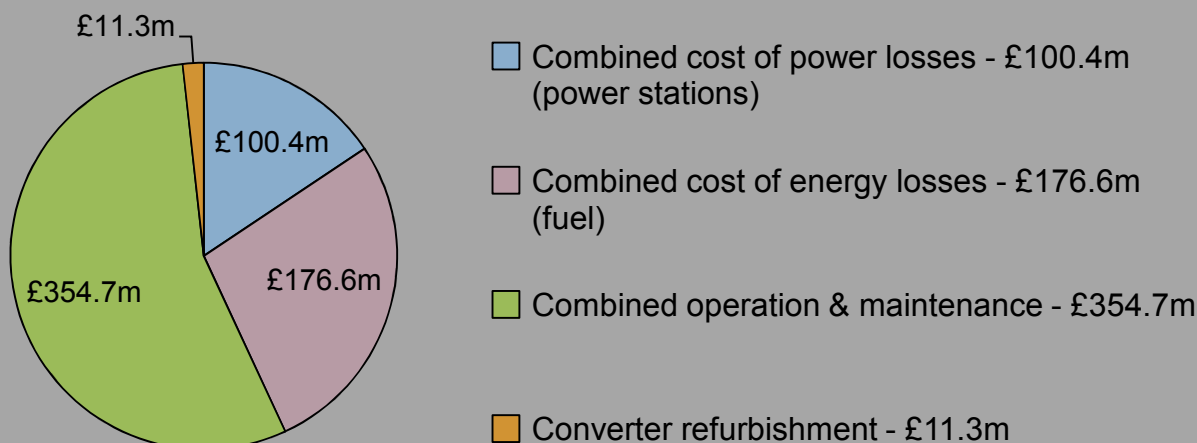

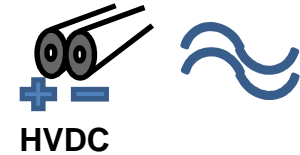

Cost Sensitivities

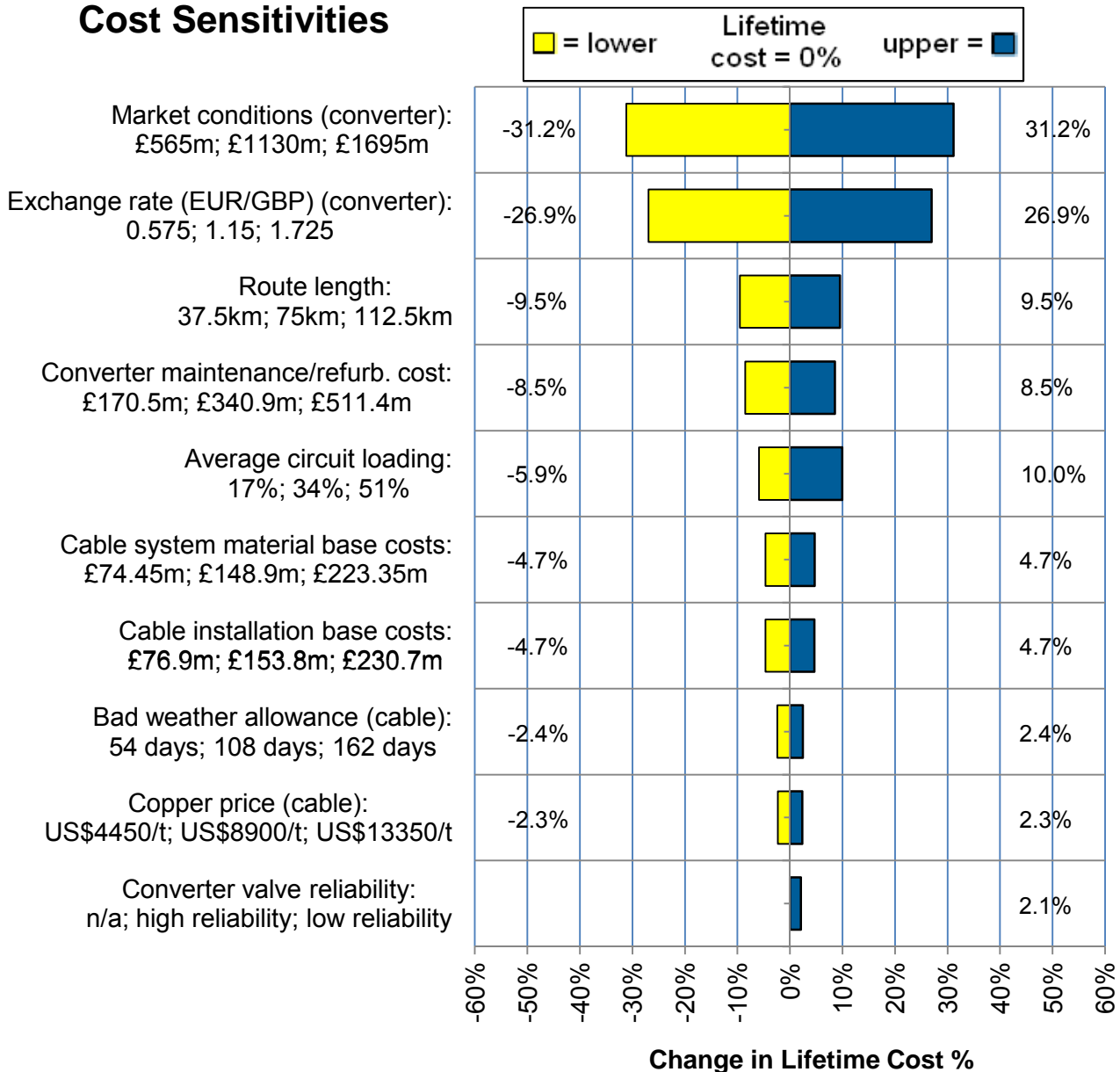

Subsea cable
HVDC converters

Lifetime Cost Results (£31.8m/km; £1330/MW-km)

| | |
|--|--------------------|
| Fixed Build Cost | £1376.3m |
| Variable Build Cost | £367.3m |
| Build Cost Total for 75km | £1743.6m |
| plus Variable Operating Cost | £643.0m |
| Lifetime Cost for 75km | £2386.6m |
| ↓ | |
| Lifetime Cost for 75km divided by route length ÷ 75km | £2386.6m |
| Lifetime Cost per km | £31.8m/km |
| ↓ | |
| Lifetime Cost per km divided by Power Transfer ÷ 6000 MW | £31.8m/km |
| Lifetime PTC* per km | £1330/MW-km |

| |
|---|
| Other Results |
| Losses = 12% of Lifetime Cost for 75km |
| Costs most sensitive to: |
| • Market conditions (converter): -31.2% to 31.2% |
| • Exchange rate (EUR/GBP) (converter): -26.9% to 26.9% |

| |
|-----------------------------|
| Notes (Jan-12) |
| * PTC = Power Transfer Cost |

8 Summary bar charts and tables

This section comprises firstly comparisons between the various technology lifetime costs, and secondly a set of tables setting out the cost ratios between overhead line and the other technologies.

Using the charts

The following charts bring together the lifetime costs per km for each of the technologies that have been detailed in the preceding pages. The charts show, for a given route length, the lifetime cost per km for each transmission technology option.

When using these charts note that:

- due to the high fixed cost of HVDC converter stations, HVDC subsea cables have only been considered over a distance of 75km,
- the typical capacity for direct-buried GIL is quoted at around 1800MVA, thus falling between the Lo and Med ratings of the other technologies; its capacity is closest to the Lo rating and, for this reason, has been displayed in this set,
- in a ventilated tunnel, the GIL power transfer capacity rises considerably, and we have thus presented GIL in tunnel costs for the Med and Hi rating levels,
- no point-to-point 400kV AC underground cable connection of 75km has been used in the world to date; the 75km UGC options have nevertheless been added here for a comparison, and
- in the following three charts the build costs associated with the linear transmission equipment (the overhead line, the underground or undersea cable, or the gas insulated line) are all shown in blue and are labelled “transmission connection”; only the end-costs associated with the HVDC options – the costs of the converters – are not shown under that label, but instead have their own label and colour in the 75km chart, Figure 8.

Figure 6 – 3km route length – lifetime costs per km

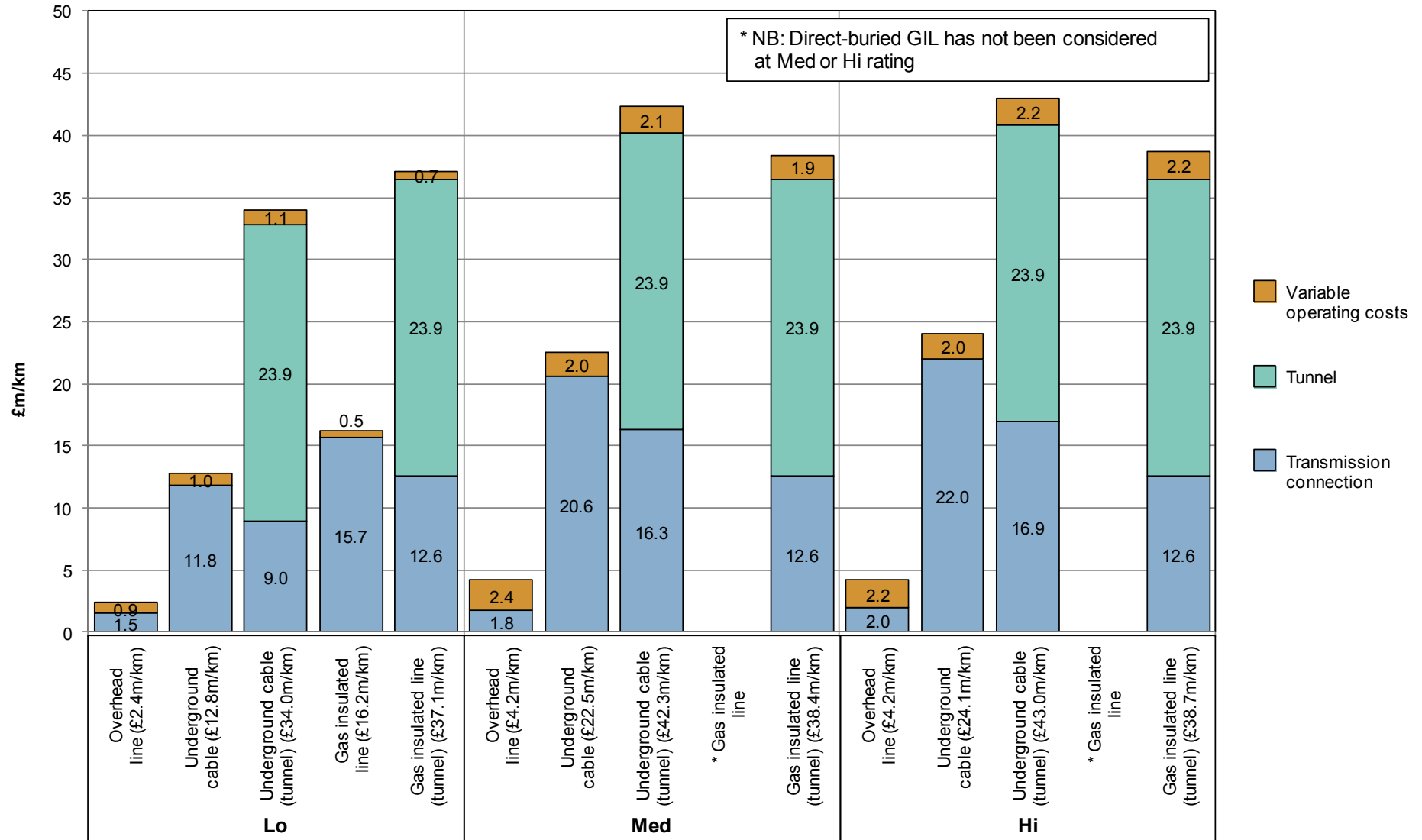

Figure 7 – 15km route length – lifetime costs per km

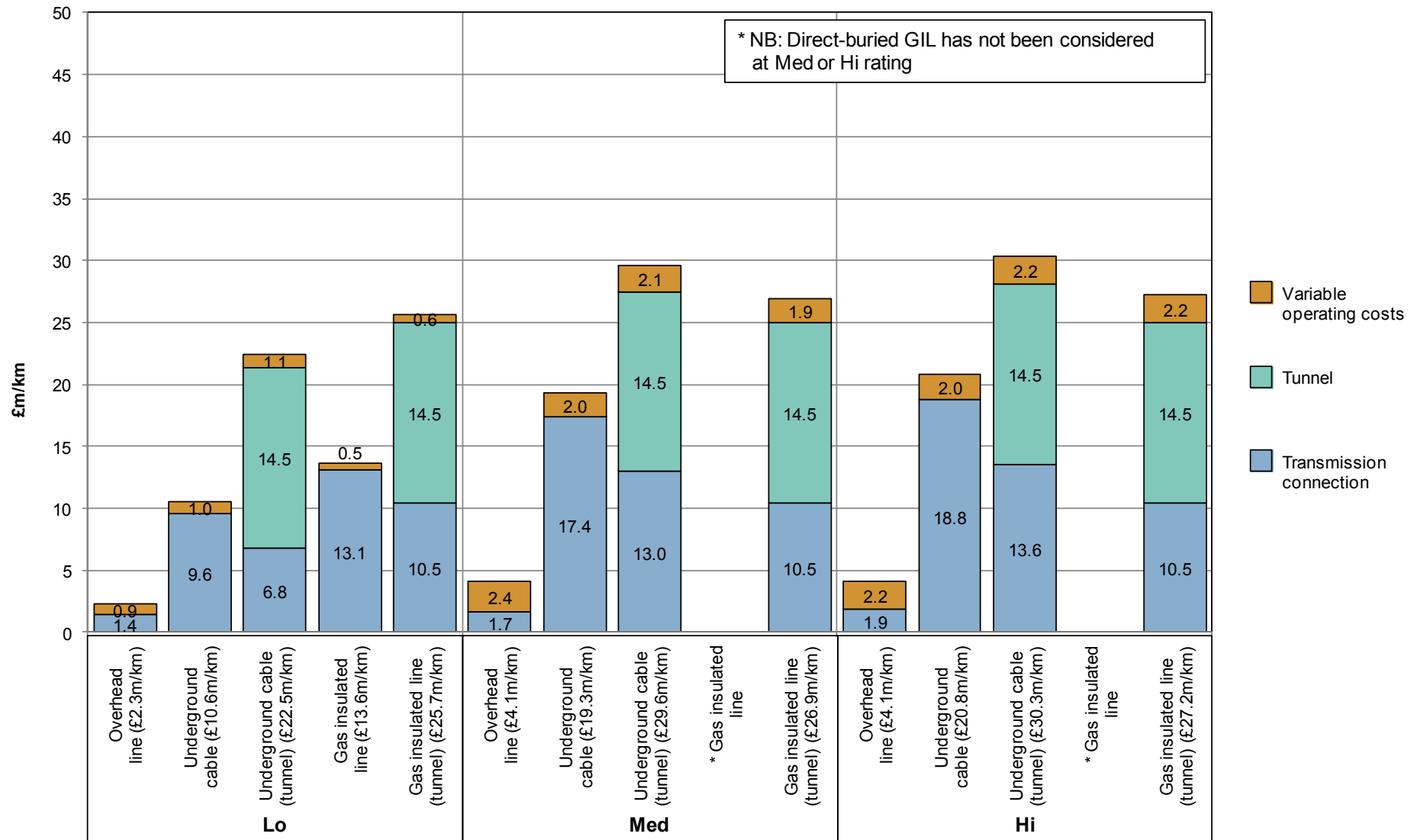
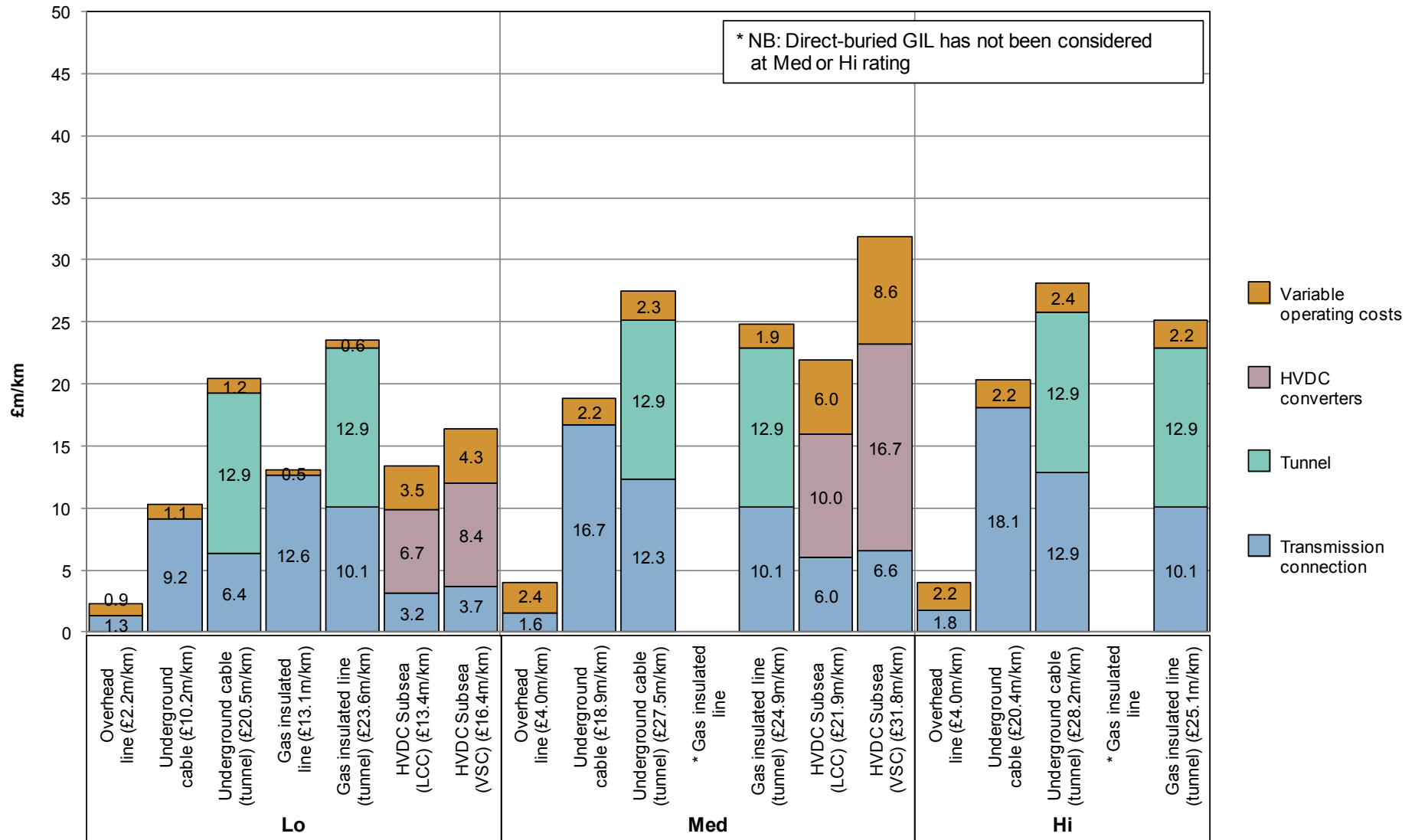

Figure 8 – 75km route length – lifetime costs per km



From these three summary bar charts we highlight the following:

- Costs per kilometre, for all technologies, tend to fall with increasing route length.
- Costs per kilometre, for all technologies, tend to rise with circuit capacity.
- All technologies emit losses, and these vary significantly with route length, with circuit capacity, with circuit loading and with transmission technology.
- For the options using a deep tunnel, the largest single cost element is invariably the tunnel itself, with costs ranging from £12.9m to £23.9m per kilometre, depending upon overall tunnel length.

We also note the following more specific points from the same charts:

- Overhead line (OHL) is the cheapest transmission technology for any given route length or circuit capacity, with the lifetime cost estimates varying between £2.2m and £4.2m per kilometre.
- Underground cable (UGC), direct buried, is the next cheapest technology after overhead line, for any given route length or circuit capacity. It thus also represents the least expensive underground technology, with the lifetime cost estimates varying between £10.2m and £24.1m per kilometre.
- High voltage direct current (HVDC) exhibits the highest proportion of losses of any of the technologies (see Figure 8). However, these losses principally occur at the converter stations at the ends of the connection, and much longer HVDC connections (not studied here) would have higher proportional efficiencies and thus lower costs per kilometre.
- HVDC – current source converter (CSC) technology currently shows itself to be the cheaper HVDC option per kilometre over 75 kilometres (ranging between £13.4m and £21.9m per kilometre), depending upon converter capacity), and these unit rates would drop as the length of the connection increased.
- HVDC – voltage source converter (VSC) technology is shown as the most expensive option over 75km, ranging between £16.4m and £31.8m per kilometre, and these unit rates would drop as the length of the connection increased. Additionally, since the VSC technology can offer distinct and unique advantages to the wider transmission system, in some circumstances this cost may be offset in other ways,
- HVDC converter technology is developing quickly and needs to be kept under review since costs could fall further as the newer and larger HVDC bipole designs are employed in the UK.
- Gas insulated line (GIL) technology is generally estimated to be higher in cost (ranging between £13.1m and £16.2m per kilometre) than the lowest rating (Lo) underground cable studied (£10.6m to £12.8m per kilometre), although the GIL equipment does have a somewhat higher rating than the compared UGC. This factor, along with any future experience of the technology in the UK, may change the effective costs per kilometre, and this situation should be kept under review.

From a comparison between sensitivity charts, we also note that circuit loading affects the level of losses on OHL more than on the other technologies.

Cost ratio tables

Under most circumstances, and for any serious application, it is more informative to refer to actual financial costs, and the cost differences, for each technology, than to quote cost ratios. Nevertheless, since overhead line to undergrounding cost ratios are frequently quoted, we calculate and present here ratios for all the technologies, for the reader's cautious use.

Table 1 – Technology cost differences and ratios: 3km route length

| Route length | Double circuit transfer capacity | Transmission technology | Lifetime Cost (£m) | Lifetime Cost difference from OHL (£m) | Lifetime Cost * Ratio (x:OHL) | Build Cost * Ratio (x:OHL) |
|--------------------------------|----------------------------------|---------------------------------------|--------------------|--|-------------------------------|----------------------------|
| 3km | Lo (3190MVA) | AC Overhead Line | 7.2 | 0.0 | 1: 1 | 1: 1 |
| | | AC Underground Cable (direct-buried) | 38.4 | 31.2 | 5.3: 1 | 7.9: 1 |
| | | AC Underground Cable (tunnel) | 101.9 | 94.7 | 14.1: 1 | 22: 1 |
| | | AC Gas Insulated Line (direct-buried) | 48.6 | 41.3 | 6.7: 1 | 10.5: 1 |
| | | AC Gas Insulated Line (tunnel) | 111.4 | 104.2 | 15.4: 1 | 24.4: 1 |
| | Med (6380MVA) | AC Overhead Line | 12.6 | 0.0 | 1: 1 | 1: 1 |
| | | AC Underground Cable (direct-buried) | 67.6 | 55.1 | 5.4: 1 | 11.7: 1 |
| | | AC Underground Cable (tunnel) | 126.9 | 114.3 | 10.1: 1 | 22.8: 1 |
| | | AC Gas Insulated Line (tunnel) | 115.3 | 102.7 | 9.2: 1 | 20.7: 1 |
| | Hi (6930MVA) | AC Overhead Line | 12.7 | 0.0 | 1: 1 | 1: 1 |
| | | AC Underground Cable (direct-buried) | 72.2 | 59.5 | 5.7: 1 | 11: 1 |
| | | AC Underground Cable (tunnel) | 129.1 | 116.4 | 10.2: 1 | 20.4: 1 |
| AC Gas Insulated Line (tunnel) | | 116.1 | 103.4 | 9.1: 1 | 18.2: 1 | |

* Note: The above lifetime cost ratios are calculated from the lifetime costs on this table. The build cost ratios, however, are calculated from the build costs presented in the charts earlier in this section. (Final printed values are subject to rounding.)

Table 2 – Technology cost differences and ratios: 15km route length

| Route length | Double circuit transfer capacity | Transmission technology | Lifetime Cost (£m) | Lifetime Cost difference from OHL (£m) | Lifetime Cost * Ratio (x:OHL) | Build Cost * Ratio (x:OHL) |
|--------------------------------|----------------------------------|---------------------------------------|--------------------|--|-------------------------------|----------------------------|
| 15km | Lo (3190MVA) | AC Overhead Line | 35.1 | 0.0 | 1: 1 | 1: 1 |
| | | AC Underground Cable (direct-buried) | 158.9 | 123.8 | 4.5: 1 | 6.7: 1 |
| | | AC Underground Cable (tunnel) | 336.9 | 301.9 | 9.6: 1 | 14.9: 1 |
| | | AC Gas Insulated Line (direct-buried) | 204.0 | 169.0 | 5.8: 1 | 9.2: 1 |
| | | AC Gas Insulated Line (tunnel) | 384.8 | 349.7 | 11: 1 | 17.5: 1 |
| | Med (6380MVA) | AC Overhead Line | 61.6 | 0.0 | 1: 1 | 1: 1 |
| | | AC Underground Cable (direct-buried) | 289.6 | 228.0 | 4.7: 1 | 10.3: 1 |
| | | AC Underground Cable (tunnel) | 444.2 | 382.6 | 7.2: 1 | 16.3: 1 |
| | | AC Gas Insulated Line (tunnel) | 404.0 | 342.4 | 6.6: 1 | 14.9: 1 |
| | Hi (6930MVA) | AC Overhead Line | 62.2 | 0.0 | 1: 1 | 1: 1 |
| | | AC Underground Cable (direct-buried) | 312.3 | 250.1 | 5: 1 | 9.8: 1 |
| | | AC Underground Cable (tunnel) | 454.7 | 392.5 | 7.3: 1 | 14.7: 1 |
| AC Gas Insulated Line (tunnel) | | 408.2 | 346.0 | 6.6: 1 | 13.1: 1 | |

* Note: The above lifetime cost ratios are calculated from the lifetime costs on this table. The build cost ratios, however, are calculated from the build costs presented in the charts earlier in this section. (Final printed values are subject to rounding.)

Table 3 – Technology cost differences and ratios: 75km route length

| Route length | Double circuit transfer capacity | Transmission technology | Lifetime Cost (£m) | Lifetime Cost difference from OHL (£m) | Lifetime Cost * Ratio (x:OHL) | Build Cost * Ratio (x:OHL) |
|--------------|----------------------------------|---------------------------------------|--------------------|--|-------------------------------|----------------------------|
| 75km | Lo (3190MVA / 3000MW) | AC Overhead Line | 168.2 | 0.0 | 1: 1 | 1: 1 |
| | | AC Underground Cable (direct-buried) | 768.6 | 600.4 | 4.6: 1 | 6.9: 1 |
| | | AC Underground Cable (tunnel) | 1533.9 | 1365.6 | 9.1: 1 | 14.4: 1 |
| | | AC Gas Insulated Line (direct-buried) | 982.1 | 813.9 | 5.8: 1 | 9.4: 1 |
| | | AC Gas Insulated Line (tunnel) | 1768.2 | 1600.0 | 10.5: 1 | 17.2: 1 |
| | | DC Subsea Cable (CSC) | 1002.0 | 833.8 | 6: 1 | 7.4: 1 |
| | | DC Subsea Cable (VSC) | 1229.0 | 1060.7 | 7.3: 1 | 9: 1 |
| | Med (6380MVA / 6000MW) | AC Overhead Line | 299.8 | 0.0 | 1: 1 | 1: 1 |
| | | AC Underground Cable (direct-buried) | 1414.3 | 1114.5 | 4.7: 1 | 10.6: 1 |
| | | AC Underground Cable (tunnel) | 2060.5 | 1760.6 | 6.9: 1 | 16: 1 |
| | | AC Gas Insulated Line (tunnel) | 1864.2 | 1564.4 | 6.2: 1 | 14.6: 1 |
| | | DC Subsea Cable (CSC) | 1644.1 | 1344.3 | 5.5: 1 | 10.1: 1 |
| | | DC Subsea Cable (VSC) | 2386.6 | 2086.8 | 8: 1 | 14.8: 1 |
| | Hi (6930MVA) | AC Overhead Line | 301.5 | 0.0 | 1: 1 | 1: 1 |
| | | AC Underground Cable (direct-buried) | 1527.8 | 1226.3 | 5.1: 1 | 10.1: 1 |
| | | AC Underground Cable (tunnel) | 2112.4 | 1810.8 | 7: 1 | 14.4: 1 |
| | | AC Gas Insulated Line (tunnel) | 1884.8 | 1583.3 | 6.3: 1 | 12.8: 1 |

* Note: The above lifetime cost ratios are calculated from the lifetime costs on this table. The build cost ratios, however, are calculated from the build costs presented in the charts earlier in this section. (Final printed values are subject to rounding.)

Cost ratios are commonly used for comparisons between underground cable and overhead line costs. However, it may be seen from the above cost comparison bar chart summaries (Figure 6–8) that the cost ratios, even between these two technologies, vary significantly with circuit length. Further, by referring to the cost ratio tables immediately above (Table 1–3), it becomes apparent that the cost ratios also vary with the circuit capacity, and that there is a disproportionate effect on the ratios from the inclusion or exclusion of the variable operating costs.

For example, to illustrate the effect of the inclusion of variable operating costs on cost ratios, in the preceding tables it may be seen that the 75km medium (Med) rating direct-buried underground cable has a build cost 10.6 times that of the equivalent 75km Med capacity OHL.⁶ In contrast, the lifetime cost⁷ of the 75km Med direct-buried UGC is only 4.7 times that of the equivalent OHL.⁸ In other words, this comparison factor, referred to as the cost ratio, more than halves when we consider the lifetime costs instead of the build costs. This change principally results from the inclusion of the variable operating costs of the OHL (in this case £2.4m/km)⁹ which are actually greater than, and dominate, the total build cost of the OHL (£1.6m/km). Whilst a similar value is also applied for the variable operating costs of the UGC (£2.2m/km in this case), this does not dominate the build cost of the UGC (£16.7m/km) which is large in comparison with its associated Variable operating costs.

However, using the same example, the difference in build costs between 75km Med capacity OHL and UGC is $16.7 - 1.6 = £15.1\text{m/km}$, whilst the difference between the lifetime costs is $18.9 - 4.0 = £14.9\text{m/km}$. These two calculations show that there is very little change to the difference in financial costs between OHL and UGC when variable operating costs are taken into account ($15.1 - 14.9 = £0.2\text{m/km}$, or just 5% of the OHL lifetime cost). Thus, despite the dramatic swing in the cost ratios, the cost differences are almost unchanged.

We conclude, therefore, that no single cost ratio adequately describes the entire relationship between the costs of the different technologies. For the circuit loadings stated by National Grid to be typical for their network (34% of rated capacity), the inclusion of operating costs in the technology comparisons does not significantly affect the overall differences in financial cost between the technologies. However, operating costs do affect the cost ratios considerably, rendering these ratios a misleading measure when making investment decisions. We thus recommend that financial costs, rather than ratios, should always be considered when making investment decisions.

⁶ The build cost ratio is 10.6:1.

⁷ Including variable operating costs, i.e. build cost plus variable operating costs.

⁸ Principally consisting of the cost of losses

⁹ The lifetime cost ratio is 4.7:1.

9 Main findings

This section draws together the following points from preceding sections of this document. First, some general conclusions about the application and present costs of power transmission technologies:

- No one technology can cover, or is appropriate in, every circumstance, and thus financial cost cannot be used as the only factor in the choice of one technology over another in a given application.
- Costs per kilometre, for all technologies, tend to fall with increasing route length.
- Costs per kilometre, for all technologies, tends to rise with circuit capacity.
- All technologies emit losses, and these vary significantly with route length, with circuit capacity, with circuit loading and with transmission technology.
- The inclusion of operating costs in the technology comparisons does not significantly affect the overall differences in cost between the technologies. However, these operating costs do affect the cost ratios considerably, rendering these ratios a misleading measure when making investment decisions. Thus financial costs, rather than ratios, should always be considered when making investment decisions.
- For the options using a deep tunnel, the largest single cost element is invariably the tunnel itself, with costs ranging from £12.9m to £23.9m per kilometre, depending upon overall tunnel length.

We also note the following more specific conclusions:

- Overhead line (OHL) is the cheapest transmission technology for any given route length or circuit capacity, with the lifetime cost estimates varying between £2.2m and £4.2m per kilometre.
- Underground cable (UGC), direct buried, is the next cheapest technology after overhead line, for any given route length or circuit capacity. It thus also represents the least expensive underground technology, with the Lifetime Cost estimates varying between £10.2m and £24.1m per kilometre.
- High voltage direct current (HVDC) exhibits the highest proportion of losses of any of the technologies (see Figure 8). However, these losses principally occur at the converter stations at the ends of the connection, and much longer HVDC connections (not studied here) would have higher proportional efficiencies and thus lower costs per kilometre.
- HVDC – current source converter (CSC) technology currently shows itself to be cheapest HVDC option per kilometre over 75 kilometres (ranging between £13.4m and £21.9m per kilometre), depending upon converter type and capacity), and costs could fall further as the newer and larger HVDC bipole designs are employed in the UK.
- HVDC – voltage source converter (VSC) technology over 75 kilometres is shown as the most expensive option over this route length, ranging between £16.4m and £31.8m per kilometre. However, technology is developing quickly in this area, and this conclusion needs to be kept under review. Additionally, since the VSC technology can offer distinct,

and unique advantages to the wider transmission system, this cost may be offset, in particular circumstances, in other ways (not estimated in this study).

- Gas insulated line (GIL) technology is generally estimated to be higher in cost (ranging between £13.1m and £16.2m per kilometre) than the lowest rating (Lo) underground cable studied (£10.6m to £12.8m per kilometre), although the GIL equipment does have a somewhat higher rating than the compared UGC. This factor, along with any future experience of the technology in the UK, may change the effective costs per kilometre, and this situation should be kept under review.
- From a comparison between sensitivity charts, we also note that circuit loading affects the level of losses on OHL more than on the other technologies.

Finally, we offer two notes of caution:

- Since no single cost ratio comparing a technology with overhead line adequately describes the entire relationship between the costs of the different technologies, financial costs, rather than cost ratios, should be used when making investment decisions.
- For comparative purposes we have used the lifetime cost per kilometre over identical distances in the report and summary bar charts. However, not all technologies connecting two locations would use the same route or be of the same length. We therefore believe that actual practicable routes need to be considered when comparing total lifetime costs of each technology for investment decisions.

Electricity Transmission Costing Study

An Independent Report
Endorsed by the Institution of
Engineering & Technology

Appendices

Issue 1.1
30 April 2012

**PARSONS
BRINCKERHOFF**

In association with:

CCI *Cable Consulting International Ltd*

The appendices which follow are designed to provide additional background information on specific aspects of the information contained in the main body of the report. Over the page we provide a contents list for all the appendices; however, to make it easy to quickly flip to the pages which relate particularly to one transmission technology or another, we have also provided “margin page tabs” for the five main technologies.

Contents

| | | |
|-------------------|--|----|
| Appendix A | Final terms of reference..... | 1 |
| A-1 | Background..... | 1 |
| A-2 | Introduction..... | 1 |
| A-3 | Output..... | 1 |
| A-4 | Procedure and scope..... | 2 |
| Appendix B | Consultant team members..... | 5 |
| Appendix C | Costing methodology and compilation..... | 7 |
| C-1 | Methodology..... | 7 |
| C-2 | Summary of the main points of the ToR affecting costs..... | 8 |
| C-3 | The use of case studies..... | 10 |
| C-4 | Technology cost data gathering and compilation..... | 20 |
| C-5 | Basis of cost comparisons..... | 21 |
| Appendix D | Losses..... | 25 |
| D-1 | Introduction..... | 25 |
| D-2 | Power and energy costs..... | 25 |
| D-3 | Carbon dioxide costs..... | 26 |
| D-4 | Assumptions..... | 26 |
| D-5 | Method – general..... | 27 |
| D-6 | Cost of energy losses..... | 27 |
| D-7 | Cost of power losses..... | 28 |
| D-8 | Note on discount rate..... | 29 |
| D-9 | Load growth..... | 30 |
| Appendix E | Technology – overhead lines..... | 31 |
| E-1 | Technology description..... | 31 |
| E-2 | Civil Works and components..... | 31 |
| E-3 | Application of the technology..... | 39 |
| E-4 | Environment and safety..... | 39 |
| E-5 | Cost make-up..... | 40 |
| E-6 | Cost sensitivities..... | 42 |
| E-7 | List of costing sources..... | 45 |
| E-8 | Anticipated future developments..... | 45 |
| Appendix F | Technology – underground cables..... | 47 |
| F-1 | Technology description..... | 47 |
| F-2 | Power cable components (XLPE)..... | 48 |
| F-3 | Application of the technology..... | 82 |
| F-4 | UGC cost make-up..... | 89 |
| F-5 | List of costing sources..... | 94 |
| F-6 | Anticipated future developments..... | 95 |

| | | |
|-------------------|---|-----|
| Appendix G | Technology – subsea cables..... | 101 |
| G-1 | Technology description | 101 |
| G-2 | Civil works and project feasibility | 106 |
| G-3 | Application of the technology | 109 |
| G-4 | List of costing sources..... | 113 |
| G-5 | Cost make-up | 113 |
| G-6 | Cost sensitivities..... | 114 |
| G-7 | Anticipated future developments..... | 117 |
| Appendix H | Technology – HVDC Converter Stations | 119 |
| H-1 | An introductory note on HVDC converters and subsea cable..... | 119 |
| H-2 | Technology description – HVDC..... | 119 |
| H-3 | Civil works | 123 |
| H-4 | Application of the technology | 124 |
| H-5 | Cost make-up | 124 |
| H-6 | Cost sensitivities..... | 127 |
| H-7 | Cost comparison – reliance on cable type..... | 127 |
| H-8 | Costing sources and confidence levels | 128 |
| H-9 | Anticipated future developments..... | 128 |
| Appendix I | Technology – gas insulated lines..... | 131 |
| I-1 | Technology description | 131 |
| I-2 | Installation options..... | 131 |
| I-3 | Civil works | 135 |
| I-4 | Application of the technology | 137 |
| I-5 | GIL cost make-up | 137 |
| I-6 | Cost sensitivities..... | 138 |
| I-7 | Anticipated future developments..... | 139 |
| Appendix J | Technology – tunnels for UGC and GIL..... | 141 |
| J-1 | An introductory note on tunnels, cables and gas-insulated lines | 141 |
| J-2 | Technology description | 141 |
| J-3 | Civil works | 142 |
| J-4 | Application of the technology | 149 |
| J-5 | Cost make-up | 150 |
| J-6 | Cost sensitivities..... | 152 |
| J-7 | List of costing sources..... | 153 |
| J-8 | Anticipated future developments..... | 153 |
| Appendix K | ENTSO-E – Europacable joint paper..... | 155 |
| K-1 | ENTSOe – Europacable joint paper..... | 155 |
| Appendix L | Planning and environment | 159 |
| L-1 | Introduction..... | 159 |

| | | |
|-------------------|---|-----|
| L-2 | The planning framework | 159 |
| L-3 | Key environmental Issues..... | 161 |
| Appendix M | Bibliography | 165 |
| M-1 | Generic references | 165 |
| M-2 | References relating to costs of losses..... | 165 |
| M-3 | References relating to costs of overhead lines | 165 |
| M-4 | References relating to costs of underground cables..... | 165 |
| M-5 | References relating to costs of subsea cables..... | 167 |
| M-6 | References relating to costs of HVDC converters | 168 |
| M-7 | References relating to costs of GIL | 168 |
| M-8 | References relating to costs of tunnels | 168 |
| M-9 | References relating to environment and planning | 168 |
| Appendix N | Letters sent by DECC | 169 |
| Appendix O | List of organisations approached..... | 177 |
| O-1 | Information requests for this study | 177 |
| O-2 | Requests for updates to previous submissions..... | 179 |
| Appendix P | December 2010 stakeholder workshop contributions received | 181 |
| Appendix Q | Abbreviations and acronyms | 183 |

Figures

| | |
|--|----|
| Figure 1 – Case Study 1 – UGC route Avonmouth | 12 |
| Figure 2 – Case Study 1 – Avonmouth route profiles | 13 |
| Figure 3 – M5 motorway looking north towards Portbury | 14 |
| Figure 4 – Case Study 2 – UGC Tickenham route..... | 15 |
| Figure 5 – Case Study 2 – ground profile..... | 16 |
| Figure 6 – Case Study 3 – UGC Mendip route..... | 17 |
| Figure 7 – Case Study 3 – route ground profile | 17 |
| Figure 8 – Case Study 4 – UGC from Pawlett to Stockland | 18 |
| Figure 9 – Combwich Reach river crossing..... | 19 |
| Figure 10 – Two common tower foundation designs | 32 |
| Figure 11 – Two rock foundation designs | 32 |
| Figure 12 – Driven and augered pile foundations | 33 |
| Figure 13 – Raft-type tower foundation | 34 |
| Figure 14 – Pile or caisson foundation in unstable ground..... | 34 |
| Figure 15 – Pile and beam foundation for flood-plane use | 35 |
| Figure 16 – The vertical configuration (left) and Danube towers..... | 37 |
| Figure 17 – Aluminium price per tonne..... | 43 |
| Figure 18 – Diagram of a 400kV Transmission Power Cable | 49 |
| Figure 19 – EHV Joint bay Containing three Joints | 53 |
| Figure 20 – 400kV cable joints near completion of the jointing process..... | 54 |
| Figure 21 – 400kV cable outdoor sealing end (ODSE) termination..... | 57 |
| Figure 22 – 400kV terminations installed near Goring..... | 58 |
| Figure 23 – Weatherproof enclosure for cable termination assembly | 59 |
| Figure 24 – Moulsoford Down 400kV SEC near Goring | 60 |
| Figure 25 – Link pillar in arable field..... | 61 |
| Figure 26 – Cable AC test voltage equipment..... | 62 |
| Figure 27 – Cable sealing end compound layout – without shunt reactors..... | 64 |
| Figure 28 – Site storage / laydown area and site administration | 67 |
| Figure 29 – Steel cable bridge over a Birmingham canal (special construction)..... | 68 |
| Figure 30 – Retaining walls and earthworks (enabling works) | 69 |
| Figure 31 – Double circuit one cable per phase – swathe cross-section | 71 |
| Figure 32 – Double circuit two cables per phase – swathe cross-section..... | 71 |
| Figure 33 – One circuit, two cable per phase – road cross-section..... | 72 |
| Figure 34 – Clearing woodland from the Swathe (Ross-on-Wye 400kV)..... | 73 |
| Figure 35 – 400kV cable swathe at the Goring Gap | 73 |
| Figure 36 – A section of trench box shoring (out of the trench)..... | 74 |

| | |
|---|-----|
| Figure 37 – A close timbered cable trench | 75 |
| Figure 38 – Cable drum carrying trailer | 77 |
| Figure 39 – Cable drum load transversely onto a trailer..... | 78 |
| Figure 40 – Offloading cable drums | 78 |
| Figure 41 – Cable installation in an open cut trench | 79 |
| Figure 42 – EHV cable trench in a public road (north-west England) | 79 |
| Figure 43 – Delivery of cement bound sand to the cable trench..... | 80 |
| Figure 44 – Top soil replacement..... | 81 |
| Figure 45 – Wimbledon – New Cross cable tunnel | 84 |
| Figure 46 – Air cooling fans during installation | 85 |
| Figure 47 – Schematic Y-branch joint..... | 97 |
| Figure 48 – Example use of Y-branch joints to maintain cable ratings | 97 |
| Figure 49 – Cable paper lapping machine applying paper tapes..... | 101 |
| Figure 50 – Subsea cable armouring process | 102 |
| Figure 51 – Subsea cable on factory turntable..... | 103 |
| Figure 52 – Single bipole arrangement..... | 105 |
| Figure 53 – Triple bipole arrangement..... | 105 |
| Figure 54 – Seabed burial arrangement of a bipole | 106 |
| Figure 55 – Cable laying vessel shore landing installation..... | 111 |
| Figure 56 – Concrete mattress (on board ship, prior to deployment)..... | 112 |
| Figure 57 – Subsea cable repair vessel (DP reel)..... | 116 |
| Figure 58 – Ballycronan More 500MW CSC converter station..... | 121 |
| Figure 59 – Typical converter station layout and size | 123 |
| Figure 60 – Short section of gas insulated line, by Siemens..... | 131 |
| Figure 61 – GIL weld edge preparation prior to connection | 132 |
| Figure 62 – GIL segment being lifted into position | 133 |
| Figure 63 – Example of direct-buried GIL double circuit | 135 |
| Figure 64 – Example of GIL double circuit in vertical-sided (surface) tunnel..... | 136 |
| Figure 65 – Example of GIL double circuit in typical bored tunnel | 136 |
| Figure 66 – Cable tunnel outline schematic..... | 143 |
| Figure 67 – Hydraulic jacks on caisson technique shaft construction..... | 144 |
| Figure 68 – Head-section of TBM being lowered into working shaft..... | 145 |
| Figure 69 – Central shaft with tunnel constructed in both directions..... | 146 |
| Figure 70 – Tunnel vehicle suspended from monorail..... | 147 |
| Figure 71 – Completed tunnel: vehicle monorail and power cables installed | 148 |
| Figure 72 – Completed shaft head-house, within a secure compound | 149 |

Tables

| | |
|--|-----|
| Table 1 – Benchmark ratings..... | 3 |
| Table 2 – Members of the consultant team | 5 |
| Table 3 – Avonmouth route length change from straight line | 13 |
| Table 4 – Overhead line energy and peak power losses..... | 28 |
| Table 5 – Effect of different discount rates on operating costs..... | 29 |
| Table 6 – Vertical vs. Danube tower comparison..... | 36 |
| Table 7 – Typical 400kV XLPE AC cable capacitance & charging current | 63 |
| Table 8 – AC UGC power transfer requirements | 70 |
| Table 9 – Failure rates of cables and accessories..... | 88 |
| Table 10 – Details of some HTSC cables and applications | 98 |
| Table 11 – Siemens GIL installations at 400kV | 134 |
| Table 12 – Potential environmental impacts from HV transmission | 162 |

Appendix A Final Terms of Reference

A-1 Background

National Grid must invest heavily over the coming years to maintain and extend the electricity transmission network in England & Wales to accommodate a number of new connections required to facilitate new low carbon sources of electricity. The majority of new connections will be subject to approval under the provisions of the Planning Act 2008 from the Infrastructure Planning Commission (IPC) (or, if certain reforms proposed to the Act in the Localism Bill become law, from the Secretary of State following examination by the Major Infrastructure Planning Unit of the Planning Inspectorate).

Major National Grid projects that are currently at the pre-application stage of the Planning Act process (Hinkley and Bramford-Twinstead) have been challenged by Members of Parliament, local residents and campaign groups on a number of issues, including the costs that the project team have put forward for underground and subsea cabling as potential alternatives to overhead line proposals. To that end, Sir Michael Pitt, chair of the IPC has asked for a study to be carried out to establish an authoritative view on the comparative costs of undergrounding and subsea cabling versus overhead power lines. This objective is supported also by the Department of Energy and Climate Change (DECC). It is recognised by both National Grid and DECC that the extent by which the costs of one transmission technology are greater or less than those of another can vary considerably according to the circumstances of any particular case. Nevertheless, an independent and authoritative report should provide a useful point of reference against which to consider estimates for particular schemes and help inform public debate and decision-making on proposals for these and other electricity network projects that are subject to the Planning Act.

A-2 Introduction

During late 2010 and early 2011 initial work was undertaken by a firm of consultants to collate relevant information and statistics to produce an authoritative report on comparative costs of different transmission technologies and factors that influence those costs. This work is currently incomplete and, as a consequence, the terms of reference (ToR) for the study have been amended and simplified. The new consultant is required to undertake the necessary work to complete the finalised study and produce a report.

The Institution of Engineering and Technology (IET) and DECC have established a Project Board. The IET will provide quality assurance of the report, and will ultimately judge whether it fulfils its intended function and is fit to be published. The objective of this arrangement is to demonstrate that the conclusions of the study are objectively based.

A-3 Output

An independent and authoritative report is sought, which will provide comparative whole-life costs for 400 kilovolt (kV) overhead line (OHL) and underground cable (UGC) transmission (including cross-linked polyethylene (XLPE) cable and gas insulated line (GIL), alternating current (AC) and high voltage direct current (HVDC) options. The options will be comparable in terms of length, rating, specification and “geometry” or scope of the project, such that the different technologies can be compared on equal terms.

The study will focus on costs and provide evidence-based cost comparators, preferably in the form of cost per km for the different technologies at different circuit ratings (or a similar metric such as £/MW/km). The base requirement is for comparison of AC 400kV double circuit single, twin and triple 700mm² overhead line conductor systems with alternative underground or subsea options. In addition, costs will be provided for alternative current source converter (CSC) and voltage source converter (VSC) 1 and 2 gigawatt (GW) HVDC systems, along with a commentary on the cost comparability of these systems with AC systems.

The objective is to provide a clear and simple analysis. The consultant will also undertake an analysis of European examples to investigate the correlation with UK data and the extent to which variations between these and UK examples can be understood.

Additional comparisons would also be useful if time permits and data is available; these include:

- different construction techniques (direct bury, tunnel, subsea)
- ratings that are lower than standard overhead line ratings, e.g. to cover circumstances where an underground section may not be required to meet the full overhead line rating.

The consultant shall present a list of additional comparisons that could be provided within the required programme based on the initial data acquired. This additional scope will be presented to the Project Board for consideration and agreement.

Once data has been collected (see next section for details of data collection), the consultant will compile a list of theoretically comparable 400kV overhead, underground and subsea system designs for agreement with the Project Board.

The study will identify any limitations in the accuracy of the comparative analysis or any external factors (including economic, physical and regulatory considerations) that can influence the relative magnitude of the costs of different technologies or their comparability. Where such factors are identified, the study should indicate to what extent their impact on costs or comparability is predictable.

The report should also summarise the practical considerations and typical environmental impacts associated with each technology. It is not the purpose of the study to examine or evaluate environmental impacts, but it should acknowledge the potential generic impacts and those that may be related to the varying characteristics of different locations.

The final report will be written in plain English in a manner that is clearly understandable to the general public and the Major Infrastructure Planning Unit (IPC/MIPU).

A-4 Procedure and scope

Data will be collected from the previous consultant, Transmission Operators, suppliers, contractors and stakeholders. International data will be an important element.

An example of a pair of theoretically similar projects could be an overhead line constructed between two locations using L12 towers with twin 850mm² conductors and underground cable with two circuits of two cores per phase of 2500mm² cables and including sealing end compounds at either end of the route. For longer cable routes, an indication will be given of the additional costs to be factored in for the reactive compensation, which would be required

for longer cable lengths. Practical benchmark ratings for various transmission technologies (which were developed during the early stages of the study) are given below:

Table 1 – Benchmark Ratings

| Capacity | Technology – 2 circuits | Per circuit / bipole configuration | Winter post-fault continuous (Cable 6 hour emergency) |
|------------|-------------------------------|--|---|
| Lo | OHL on L8 towers | 2 × 570mm ² aluminium alloy conductors per phase | 2 × 1595MVA = 3190MVA |
| | UGC in 2 trenches | 1 × 2500mm ² copper conductor per phase | |
| | GIL in 1 trench | 1 × 5300mm ² aluminium alloy conductor per phase | |
| | 2 HVDC bipoles + subsea cable | 1 copper conductor cable pair per bipole | Total 3000MW |
| Med | OHL on L12 towers | 2 × 850mm ² aluminium alloy conductors per phase @ 90°C | 2 × 3190MVA = 6380MVA |
| | UGC in 4 trenches | 2 × 2500mm ² copper conductors per phase | |
| | GIL in 1 tunnel | 1 × 5300mm ² aluminium alloy conductor per phase | |
| | 4 HVDC bipoles + subsea cable | 1 copper conductor cable pair per bipole | Total 6000MW |
| Hi | OHL on L6 towers | 3 × 700mm ² aluminium alloy conductors per phase @ 75°C | 2 × 3465MVA = 6930MVA |
| | UGC in 4 trenches | 2 × 3000mm ² copper conductors per phase | |
| | GIL in 1 tunnel | 1 × 5300mm ² aluminium alloy conductor per phase | |

The whole-life costs shall include all capital costs that would ultimately be transferred on to the asset register under Ofgem rules and OPEX costs such as operation and maintenance and transmission losses. The capital costs will include all normal consents costs, mitigation, design and engineering, transmission owner (TO) costs, mobilisation, temporary and permanent facilitation works (e.g. access roads and utility diversions), supply of materials, construction and commissioning. In addition, consideration shall be given to including mid-life refurbishment requirements and the impact that asset life has on the whole-life costs. The methodology for incorporation of these aspects shall be agreed with the Project Board.

Extraneous costs that are not necessarily incurred by the choice of a particular technology, such as substation costs and one-off unusual costs peculiar to particular projects rather than inherent in the choice of a given technology will be removed/excluded/not used.

Where the data collected is for two or more projects which are not exactly comparable as they stand, the consultant will use other benchmarks and/or experience to make adjustments to the data to allow comparable costs to be computed. An example would be where single circuit cable data is available, but the comparable project is two circuits; in this case the consultant would find a means of adjusting the single circuit figures to arrive at an appropriate estimate of what the two circuit figures for the project would have been.

Where possible the data will be collected in sufficient detail to enable costs to be produced on a “bottom up” basis, such that the content (or scope) of the prices is fully established. This would help to minimise the use of lump sums and the danger of being unclear exactly what scope the lump sum refers to.

This methodology provides a means of achieving the aims of this work and should be used as a guide, but should be kept under review and adjusted in liaison with the LPM/Project Board to ensure that the programme is met.

Appendix B Consultant Team Members

Table 2 – Members of the consultant team

Parsons Brinkerhoff

| | | |
|-----------------------------|----|--|
| Mark Winfield | PB | Project Manager, joint author and editor |
| David Thorn | PB | Project support |
| Martin Safranek | PB | Contributor – overhead lines |
| Allan Burns | PB | Contributor – HVDC |
| Ian Robson | PB | Contributor – GIL |
| Rory McKimm, Terry Howes | PB | Contributors – tunnels |

Cable Consulting International

| | | |
|-------------|-----|--|
| Simon Lloyd | CCI | Joint author and contributor – underground and subsea cables |
|-------------|-----|--|

Appendix C Costing Methodology and Compilation

C-1 Methodology

The only way to be (more-or-less) certain of the cost of a particular electricity transmission project at a given time is to widely consult with stakeholders and to agree a contract for its construction.

Nevertheless, cost estimates may be made – indeed must be made – before a project proceeds, and these estimates must thus be developed without the luxury of such contractual certainty. This document offers a straightforward approach to pre-contract transmission project cost estimating for comparison of one technology against another, based upon UK case studies. Cost sensitivities are given and, by the correct application of these sensitivities to the lifetime costs, we anticipate that most actual contract costs would lie within $\pm 20\%$ of those indicated here. Please note, however, that in respect of contracts, this report does not make any recommendation for the use of a particular technology in any given application.

Our methodology, which was discussed and agreed with the Project Board to ascertain costs, is outlined in the following list. Though written here as a sequence, often several of these tasks were addressed simultaneously:

- Establish the scope of the study, based upon the terms of reference.
- Establish practical circuit capacities against which to compare the various technologies being studied.
- Establish a list of organisations to be contacted by DECC to request support for the study and for the data requests to follow. Also, draft letters appropriate to each type of organisation (four in total).
- Establish a further list of potential data sources where we already have contacts.
- Prepare a number of case studies for reference by data sources to fix, where necessary, a wide range of assumptions regarding location dependent costs.
- Develop a detailed list of data, relevant to each technology, which would feed into the study. Write to all potential data sources with requests for data, attaching case study data where necessary.
- Obtain the list of correspondents of the IET's 9 December 2010 transmission costing seminar, and write to each, informing them of the further work, and inviting updates to their inputs on transmission costing.
- Design a report structure that would communicate the results of the study in as straightforward and easily accessible a manner as possible.
- Outline the content of the report, and obtain agreement of its structure from the Project Board.
- Fill out the descriptive text of the report, for comment by the independent members of the Project Board.
- Analyse and process contributions from data sources. Include, where relevant, material from learned publications by CIGRÉ, ENTSOe. Present

the draft results in a combined graphical and text format, for comment by the independent members of the Project Board.

- Continue to seek further data input until the cut-off point in early December 2011.
- Establish a final draft for proofreading, checks for factual accuracy and other QA functions, and produce a final report in electronic format.

C-2 Summary of the main points of the ToR affecting costs

The following is a condensed summary of the main requirements of the terms of reference (ToR) for obtaining and presenting the costs of each technology.

- Costings of 400kV OHL, UGC, GIL, transmission systems for land and subsea application, as applicable
- AC land and DC subsea systems to benchmark ratings (see Table 1 in Appendix A)
- Technologies to be comparable on equal terms
- Different construction techniques (direct bury, tunnel and subsea)
- Data collection from the consultant, transmission operators (TO), suppliers, contractors and stakeholders
- Where possible the data will be collected in sufficient detail to enable costs to be produced on a “bottom up” basis, such that the content (or scope) of the prices is fully established.
- The capital costs will include all normal consents costs, mitigation, design and engineering, transmission operator costs, mobilisation, temporary and permanent facilitation works (e.g. access roads and utility diversions), supply of materials, construction and commissioning. In addition, consideration shall be given to including mid-life refurbishment requirements and the impact that asset life has on the whole-life costs.
- Whole-life cost to be valued including losses
- Extraneous costs (those not directly associated with the installation of new transmission circuits themselves) to be excluded
- Cost information presented as cost comparators
- Declare limitations on accuracy

The requirements of the ToR were quite prescriptive. Several challenges had to be faced in order to place each of the technologies on a comparable bottom-up¹ cost-estimating basis. One particular issue was how best to convey the various “fixed” costs associated with circuit terminations, tunnelling and subsea installations.

This document concentrates on 400kV transmission technologies for the UK, and considers the following set of double circuit arrangements:

¹ Bottom-up cost: A cost calculated by obtaining quantities and prices at the lowest reasonable level of detail and summing these to arrive at a total.

- 400kV overhead line
 - three different lengths, each for
 - three different ratings
- 400kV underground cable
 - direct buried, and in a tunnel, each for
 - three different lengths, each for
 - three different ratings
- 400kV gas-insulated line design
 - direct buried, and in a tunnel, each for
 - three different lengths, each for
 - three different ratings
- HVDC subsea cable and converters
 - two different converter technologies – CSC & VSC – each for
 - two different ratings

The technology alternatives listed above are not an exhaustive set, but they are envisaged to cover the majority of UK transmission requirements in the near-term.

Overhead line at 400kV has been installed for over 50 years in the UK and provides the backbone of the UK electricity transmission network. Single circuit OHL has not been considered as it represents an inefficient use of the transmission corridor, and is non-standard in the UK.

Underground cable at 400kV has also been available for over forty years, with the first oil-filled 400kV circuits installed in the UK in 1969.² The modern 400kV XLPE cable was first installed in the UK (as three short connections without joints) at the Rocksavage power plant in 1998 and the first long length 400kV transmission cable installed between Elstree and St John's Wood substations in 2005.³ This study considers only XLPE insulated cable systems as these employ modern materials which are capable, for all practical purposes, of matching the performance of oil-filled cables.

The possibility of installing a “spare phase” in place of a second underground cable circuit has not been pursued, as this arrangement has no net benefit in a meshed network. In the case of a hybrid circuit containing both UGC and OHL, neither the current rating requirements nor the regulatory requirements would be met by the use of a “spare phase” in place of a second circuit.

The combination of HVDC converters using CSC technology and mass impregnated subsea cables (MI) is also a mature technology at 400kV. The study also includes VSC converter technology at 320kV and solid dielectric cables suitable for use with this technology. Although VSC technology has not yet reached the 400kV DC level, it was decided to include this technology in the study as the capabilities of the technology are being developed very quickly.

² “Electric Cables Handbook”, Bungay, E. et al., BSP professional Books, 2nd Edition, London, 1990, ISBN 0-632-02299-X, Table 1.1

³ “Case Study 1 – new cable tunnel”, National Grid Publication, <http://tinyurl.com/85haoaa>

Gas insulated line is a relatively recent technology and not as mature as overhead line. Most of the 400kV gas insulated line in the world has been installed either in a tunnel, or above ground in air. There has only been one installation of a direct buried gas insulated line, which was completed recently, and thus its track record and the knowledge base on the cost of installing it, directly buried in the ground, at 400kV is very limited. The option of a “spare phase” installation has not been pursued for the same reasons as those given for UGC above.

C-3 The use of case studies

A significant difficulty in producing lifetime costs for each technology is that of the “typical cost”. When asking a supplier or installer for the “typical cost” of anything, other than the most basic of commodities, it is seldom that the supplier will respond without requiring a clarification of what the questioner considers to be “typical”. By way of example, a request for a “typical cost” of a dwelling in the UK will likely require the questioner to answer some basic clarifications such as, where in the UK the dwelling is to be situated and how many bedrooms it has. These are sensible requests as a pertinent response will improve the accuracy of the result.

When asking a supplier and installer for a transmission technology cost, particularly a buried technology, they, too, will be better able to provide a more useful cost estimate if the costing requirements can be clearly specified. It was therefore decided that, for the buried and subsea installations in particular, a number of case studies be provided such that the cost estimators of each technology were able to base their costs on the same physical location.

We sought to satisfy a number of criteria in the selection of case studies. These were as follows:

- For the UGC/GIL/OHL, the case studies should travel across various rural terrain types and for the UGC and GIL at least one case study should include an urban/peri-urban installation.
- The terrain selected should not be so extreme that it rendered one technology particularly at an advantage over another. We were looking for cost comparisons not comparing the suitability of each technology to a particular terrain.
- At least one case study should consider a subsea connection.
- For practical and time limitation purposes, the case studies would all be located in the same region of the country, and all be shorter rather than longer to ease assessment.
- The case studies, if possible, should be in a location where one or more 400kV transmission connections were being considered.

After some consideration five case studies were chosen across various terrains and obstacles in the Somerset area. Four locations were on land and the fifth a connection laid along the Bristol Channel

It should be noted that, whilst the locations considered are currently topical (National Grid wishes to install a 400kV transmission connection in or around these areas), these routes have not been selected on any basis other than for the nature of their terrain and to determine a cost per km for transmission installation. It is not the intention of this report to recommend, or indicate in any other way, the need for a particular transmission connection,

the selection of a particular transmission route or the adoption of any given transmission technology.

Case studies 1 to 4 are overland and case study 5 is subsea:

- case study 1: Avonmouth – urban and industrial areas
- case study 2: Tickenham – rural hillside
- case study 3: Mendips – rural valley
- case study 4: Pawlett – rural salt flats and large river crossing
- case study 5: Hinkley to Seabank – subsea connection

The alignment of the case study cable routes has been made following a brief site visit and desktop study. The route alignments do not include any consideration of a detailed environmental impact assessment.

It will be seen from the case studies that the route lengths of the studies do not align with the 3km, 15km and 75km costing given in the lifetime cost charts section of the main report (Section 7). It was considered that it would be unduly onerous and a less fruitful use of time allocated to our study for estimators of companies to interrupt their commercial workload with long 15km and 75km case studies. The object of the case studies is to establish fixed costs and costs per kilometre across terrain types and then to use these costs to estimate the installation costs over different lengths.

In order to avoid unnecessary complication, we have not included the estimates from each of the case studies in this report. The information from the case study results was, however, used to provide data for the lifetime costs and the sensitivity analyses given for each technology in Section 7 the main report.

C-3.1 Case study 1 – Avonmouth

This is a case study from a terminal compound positioned on the banks of the River Avon to Seabank substation.

The underground routes shown in Figure 1 were selected by the authors in conjunction with an estimating engineer from a cable supplier and installer. It was considered, from an above-ground inspection, that it should be possible to route a connection between a cable sealing end compound at the edge of the River Avon and Seabank substation.

However, the majority of roads along the route could only be expected to accommodate two cable trenches, each containing three power cables. Very few of the roads, however, would accept a GIL trench without significant road closures due to the trench width. Even this statement is made on the assumption that GIL could withstand the surface load of the traffic (no installations of directly buried GIL have been performed in a city environment).

It was therefore necessary to find two alternative routes from the sealing end compound (SEC) on the banks of the Avon to Seabank power station.

The straight line distance between the SEC and a designated point in the power station is measured to be 5.21km. The two routes found were the eastern route of 7.81km marked in blue and the western route 7.89km marked in red in Figure 1.

Figure 1 – Case study 1, UGC route Avonmouth



Figure 2 is a profile of the eastern and western routes. It can be seen that in this particular case study the route profile is reasonably flat with only a 5m difference in height between the highest and lowest points.

Figure 2 – Case study 1, Avonmouth route profiles

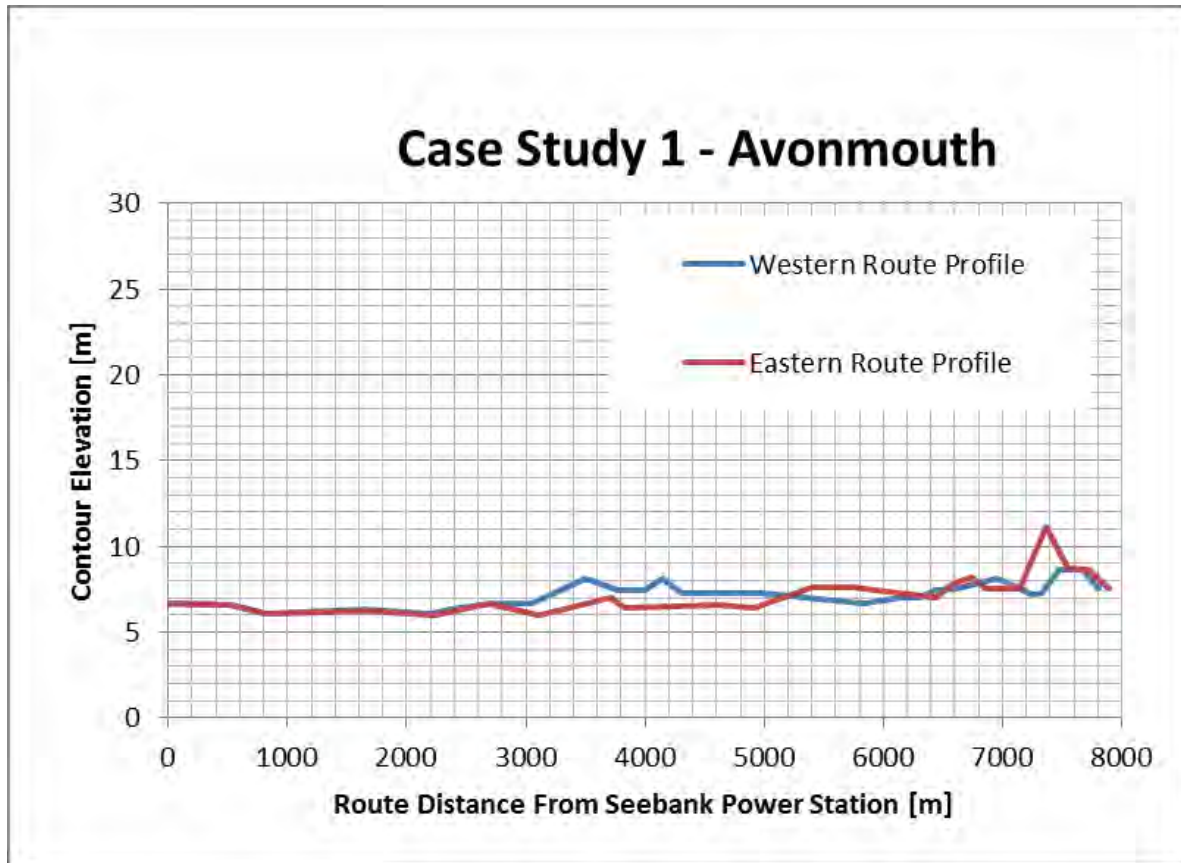

The route deviation from the straight line for each of the Avonmouth routes is given in Table 3.

Table 3 – Avonmouth route length change from straight line

| Route | Route Length [m] | Straight Line Length [m] | Increase in length [m] | Percentage increase from straight line |
|---------|---------------------|-----------------------------|---------------------------|--|
| Eastern | 7810 | 5210 | 2600 | 49.9% |
| Western | 7890 | 5210 | 2680 | 51.4% |

The deviation from a straight line increase in route length is due to:

- the need to avoid private property, particularly buildings, and to keep the cable trenches beneath the roads,
- the lack of road width to allow all the cables to pass along the shorter eastern route, and
- avoidance of an unsuitable road bridge which would not accommodate the cables.

C-3.2 Case study 2 – Tickenham

In order to obtain a cost for installation over hilly farmland a route was selected between Portbury and Tickenham as shown in Figure 4.

A ground elevation profile (Figure 5) of the case study route between a sealing end compound in Portbury and another in Tickenham was drawn using data from the Ordnance Survey. The data indicates that the lowest elevation exists at the Portbury SEC of 7.5m and the highest at 135m elevation at a position 2560m further along the route. The steepest local incline over a distance greater than 100m has been calculated to be 1 in 4.8 and over 500m of 1 in 8. These are manageable inclines using existing installation trenching without the need for specialised installation equipment.

The route additionally includes a crossing of the M5 motorway (Figure 3) which would need to be crossed using a directional drilling technique. If soil conditions would not allow such a drilling, boring or tunnelling method to be used then the options are either to open cut the road and place ducts just under the surface of the road or to install an overhead gantry. Each of these methods incurs additional cost to an open cut methodology and would be classed as a “special construction”.

Figure 3 – M5 Motorway looking north towards Portbury



(Courtesy of Cable Consulting International)

Figure 4 – Case study 2, UGC Tickenham route

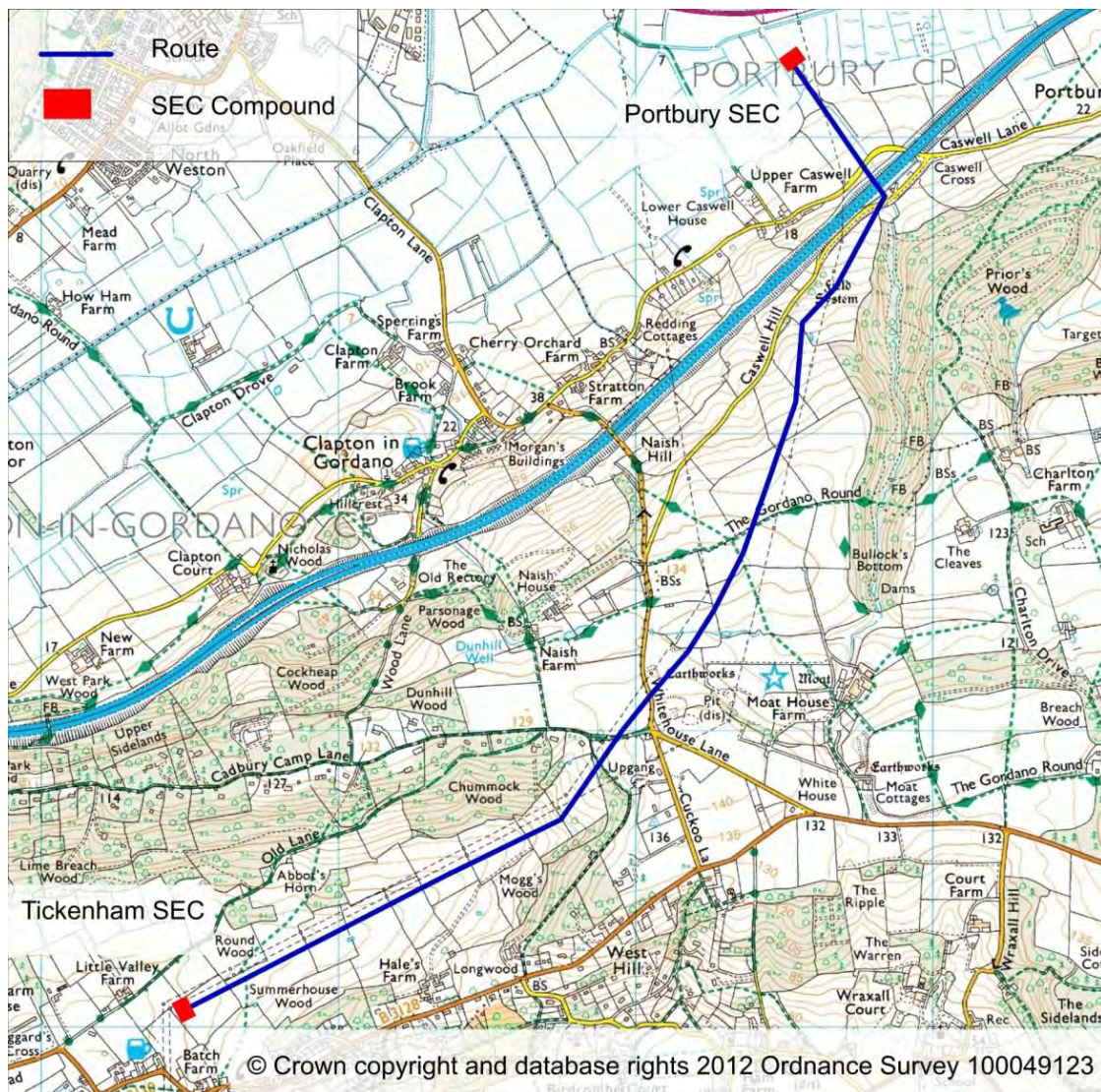

The coordinates of the cable sealing end compounds considered are:

Portbury SEC: N 51° 28' 25", W 2° 44' 33"
 Tickenham SEC: N 51° 26' 41", W 2° 46' 17".

The total route length between the SECs has been scaled to be 4340m. The straight line distance between the two compounds has been measured to be 3770m. Thus the route deviation from the shortest distance is 15.1%.

This additional length was required to:

- find a suitable position for the drilling under the M5
- avoid existing buildings and structures
- avoid steep transverse inclines
- avoid passing through significant areas of woodland.

Figure 5 – Case study 2, ground profile

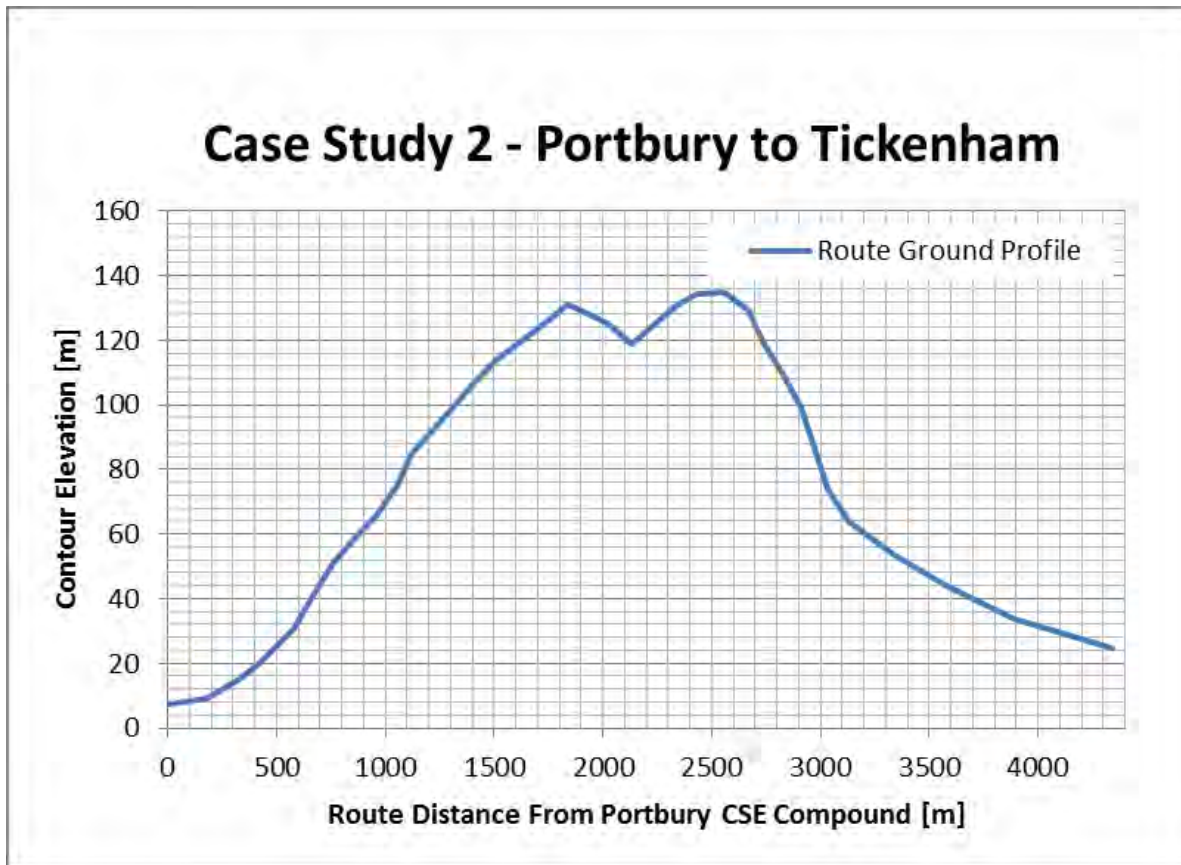

C-3.3 Case study 3 – Mendip Hills

A route was considered that passes through the Mendip Hills. In conjunction with a cable cost estimator, a route was selected through the hills and shown in Figure 6. This route has been drawn from Lox Yeo CSE in the south to Towerhead SEC in the north. The route passes through the valley of the Lox Yeo river, largely following the route of the existing 132kV OHL.

The position of the two end points of case study 3 route are:

Lox Yeo SEC: N 51° 17' 40", W 2° 53' 36"
 Towerhead SEC: N 51° 19' 59", W 2° 50' 36"

The area through which the case study route passes is largely farmland. The valley floor is sparsely populated with roads and thus access to the land for heavy vehicles and plant would require the construction of a haul road to support the weight of traffic entering the valley. The main access to the site works would need to be via the A371.

The difficulty of excavating the ground on this case study was considered to be for practical purposes the same as case study 2. However, as the profile (Figure 7) is essentially flat, although there is a short section near Lox Yeo CSE with a profile of 1 in 15, the haul road would not need to be as highly specified.

Figure 6 – Case study 3, UGC Mendip route

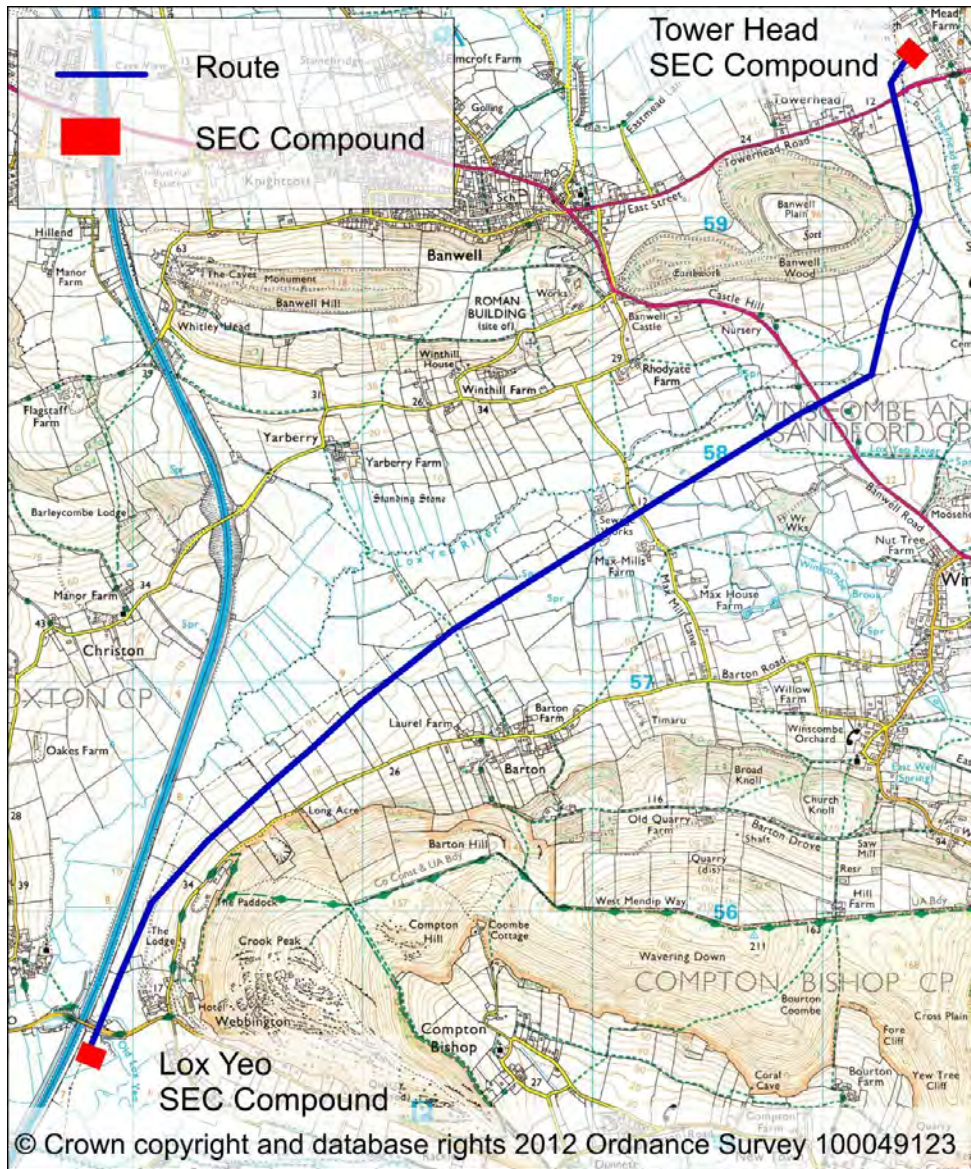

The route length as scaled from survey drawings is 5970m whereas the straight line distance between the two SECs has been scaled to be 5520m. Thus the increase in route length due to deviation is 450m (8.1%).

The deviation from the straight line has been created by the need to:

- avoid existing buildings and structures
- avoid historic monuments
- ease construction cost, time and effort by avoiding steep transverse slopes
- ease construction cost, time and effort by avoiding steep inclines or descents
- avoid cutting a visible and permanent path through ancient woodland

Figure 7 – Case study 3, route ground profile

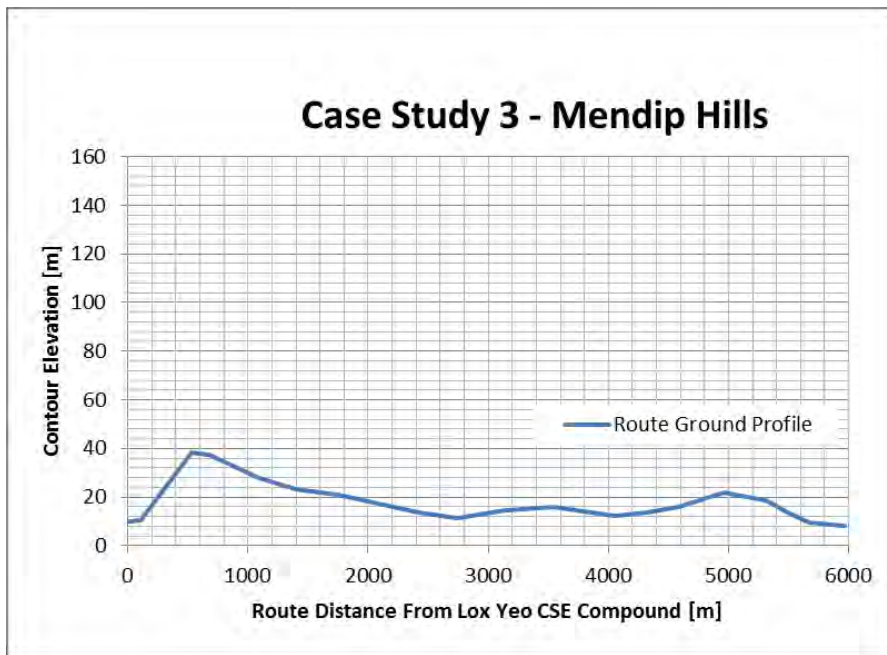

The position of the Towerhead SEC could also be subject to revision due to the proximity of Towerhead Brook, as there may be a risk of contamination of the brook if the CSE is built too close to it, particularly if the compound is built to contain a compensation reactor (as these are filled with hydrocarbon oils).

C-3.4 Case study 4 – Pawlett

This case study includes a large salt water river crossing, and the crossing of a number of field drains.

Figure 8 – Case study 4, UGC from Pawlett to Stockland

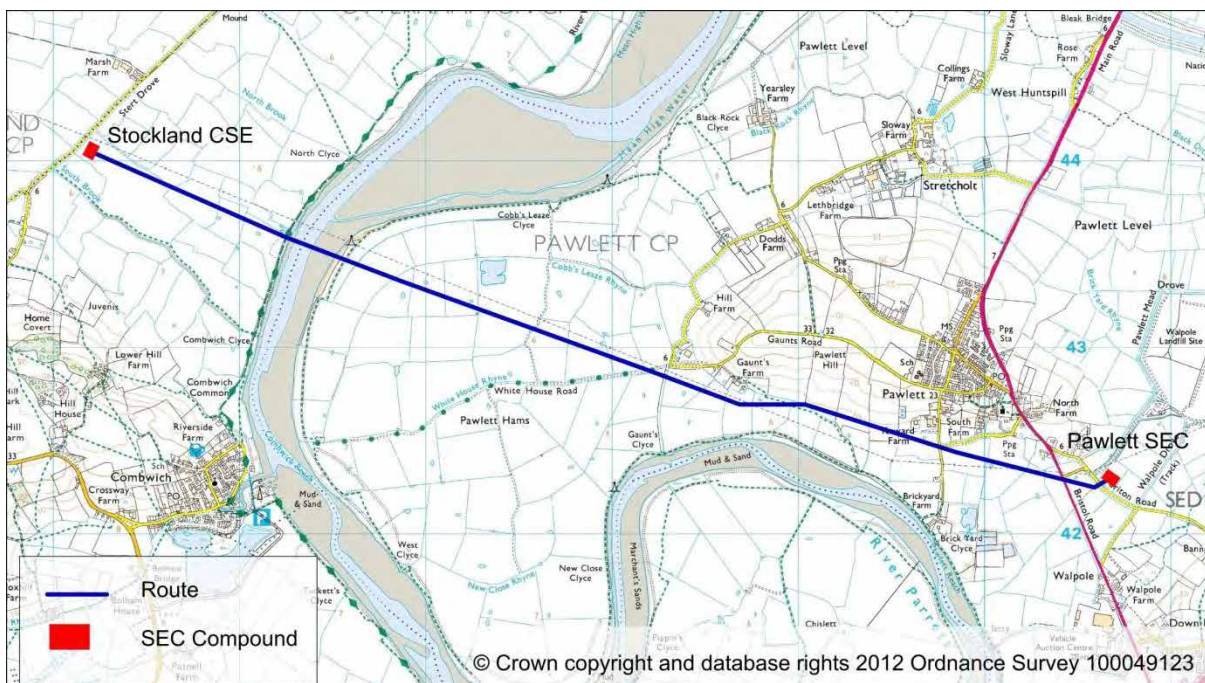

The location of the start and end points for the cable route selected by the author with the assistance of a cost estimator were:

Pawlett SEC: 51° 10' 31", W 2° 59' 35"

Stockland SEC: N 51° 11' 26", W 3° 4' 17"

Figure 9 – Combwich Reach river crossing



These locations were chosen to include the tidal river crossing at more or less the same position as the existing overhead line and to underground the line across the open land in the view of the villages of Pawlett and Combwich.

The straight line distance between the two SECs is 5730m. The length of the cable route as aligned is 5760m, a route deviation away from the straight line distance of only 30m, or 0.5%.

This minor route realignment additional length is required to avoid existing buildings and structures.

The route also includes a crossing under Combwich Reach. There is an existing overhead line crossing of this reach, shown in Figure 9.

C-3.5 Case study 5 – Hinkley – Seabank subsea connection

This case study considers a DC cable link between the coast near Seabank power station (51° 32' 19" N, 2° 40' 28" W) to the coast near Hinkley Point power station (51° 12' 29" N, 3° 7' 21" W).

The straight line distance between the two SECs is 48.24km. The length of the cable route as aligned is 50.94km, a route deviation away from the straight line distance of 2.7km. This route realignment additional length is required to maintain the route at sea.

Most manufacturers and installers of subsea cables are very active at present with offshore business opportunities. However, despite the demands of commercial opportunities, subsea cable system responses were received from:

- Nexans
- JPower Systems Corporation
- Viscas Corporation

- Visser Smit Marine Contracting
- Global Marine Systems Limited
- National Grid (top-down⁴ costs)

A number of those who responded required price confidentiality and thus confidential costs have combined with other costs.

The fixed and variable prices from this case study have been used to compile the 75km costings for the various power transfer requirements. Details of the costs obtained were directly used to provide the 75km cost of installation of cable from a northern European supplier. Prices of cable from other ports in the Mediterranean and the Far East will increase the costs.

C-4 Technology cost data gathering and compilation

The authors were also aware that such a study does not come without one or other organisation or person seeking to persuade the authors on the cost or nature of a particular product, which might be exaggerated or understated. It was essential therefore that all of the information gathered was analysed by the consultant team in order that only credible data be included in the study. Thus the content of this report not only relies on the information supplied to the consultant team as raw data but also on their experience and professional judgement.

The main purpose of the report is to inform the reader as to the cost of one technology compared to the next, and that it should provide a cost of installation in England and Wales. There is only one owner and operator of the transmission network in England and Wales, and thus the owner costs in England and Wales can only be provided by National Grid. In discussion with National Grid engineers, the internal costs of National Grid in launching and managing projects was discussed in order that costs could be included in accordance with the terms of reference. These costs are separately identified in the reports tables and lifetime cost analyses as “project launch and management” costs. It has not been possible for the authors of the report to dissect these costs as they are a top-down cost taken by National Grid engineers from recent projects. It is not the position of this report to comment upon whether these costs are too high or too low. However, we have included in the lifetime costs, as a percentage of the build cost (before contingency), a cost for this activity.

No substantial information was provided to assist in establishing how, if at all, the project launch and management costs vary across Europe. One reason for this is likely to be the duration between the study launch and data collection; large organisations tend to move slowly and cautiously, particularly where there is public scrutiny of this topic in a number of EU countries. It is possible that the publication of this report will not only be of assistance to those in the UK but will also be of interest in other European countries, the transmission operators of which might feel able to contribute, should the study be periodically reviewed.

It should be noted that the overhead line costings illustrated in Section 4 of the main report were derived largely without the need for referral to the case studies as the effect of terrain is small and urban OHL developments have not been considered.

⁴ Top-down costs: these are costs where the final project delivery price is known (the project is complete) and costs are broken down into identifiable sums; normally these sums are contractor payments and internal costs.

Installation of UGC or GIL in tunnel has also not referred to the case studies since tunnel installation (especially deep tunnel installation) is largely subject to costs associated with the underlying geology. The tunnel costs have been applied to both GIL and UGC.

Where our sources have requested anonymity or have asked for data to be included but not disclosed in detail for commercial or other reasons, these wishes have been respected in every case. Regarding anonymity, the list of organisations contacted, Appendix O, is just that. No inference of data having been provided may be drawn from this list.

Using the case studies, it was possible to compare the costs of one technology against another on similar activities. The authors were also aware that in asking for cost estimates, that some estimators would supply all details that were asked, others would supply cursory information and yet others no information in some areas.

The data sets received from estimators and other data sources therefore varied in density, with plenty of data in some areas, e.g. cable materials costs, and less in others, e.g. GIL costs. The consultant team therefore needed to employ their own professional judgement in some areas to ensure that, as far as possible, the cost data given was comparable between technologies and presented without bias.

C-5 Basis of cost comparisons

Estimates now: The equipment costs presented in this document are **estimates**. They are estimates of the costs that we might expect to pertain were contracts for new transmission circuits to be let at the time this report was written so, whilst some references have been made to future technology, this report does not contain detailed cost estimates for those solutions.

Life costs: Our cost estimates identify both the equipment procurement costs and those other costs for which a transmission operator incurs beforehand and over the life of the equipment. These include the stakeholder consultation process,⁵ outline and detailed design, pre-construction investigations, supplier and installation contracts, project management and engineering, legal and administrative costs prior and during construction, and the maintenance and losses costs associated with running the equipment over its lifetime.

Most transmission equipment is deemed to have a technical life in excess of 40 years although, in practice, some technologies require a major refurbishment at mid life, whilst others do not require replacement even after 50 or 60 years or more.

Costing factors: The cost of new transmission equipment installations is sensitive to many factors, including the transmission capacity required, the terrain through which the connection runs, world metal prices, the cost of labour and the currently prevailing transmission equipment market itself. The length of the connection is also an important factor when calculating unit costs (the cost per kilometre, or the cost per megavolt-amp per km), since project “setup costs”⁶ and connection “end costs”⁷ are significant in their own right,

⁵ Stakeholder consultation: National Grid has recently developed, through consultation with statutory consultees and other stakeholders, a new approach to transmission routing process entitled “Our approach to the design and routing of new electricity transmission lines”.

⁶ Set-up costs are those one-off costs associated with design, planning and administration, and project site set-up before construction of the transmission connection itself can begin, along with those costs

even before the variable costs per km are taken into account. For long connections, the setup and end costs may represent only a small proportion of the overall contract cost, but for short connections, these costs can dominate the variable costs, raising the unit cost significantly.

Future-proofing: Information about the extent to which equipment costs are based upon commodity prices, particularly metal prices, provides a measure of future-proofing, but we have been unable to apply this approach comprehensively.

Other factors will also tend to modify transmission costs in the future. Some possible examples include the following:

- New materials will tend to bring down the overall lifetime cost of the existing technologies – for example, low thermal resistivity trench backfill could reduce the swathe width for underground cables, or lower the amount of copper required in them.
- New designs could provide cost or other benefits – for example, the recently announced T-Pylon overhead line (OHL) design could offer reduced visual impact – though the effect on OHL cost is uncertain at present.
- Emerging technologies: Our estimates on emerging technologies such as buried GIL are less reliable due to the limited number of existing UK installations.
- Developing technologies: Technologies such as HVDC converters are installed on the UK network relatively infrequently. This, combined with their present high rate of technical development, means that two identical converters are hardly ever ordered, which results in bespoke designs for every installation. We cannot forecast in this document whether, for any future project, its bespoke design, which would tend to push up the cost, would be more, or less, influential than the new technical developments which may tend to lower the cost.
- Future technologies: It is difficult to predict how technologies yet to arrive on the UK transmission market will affect transmission lifetime costs, because they rarely arrive “on their own”. For example, superconducting cable technology is in its infancy for power transmission, and no long-distance installations have been installed in the UK. However, we are unable to predict where other world factors, such as the “cornering” of the materials necessary for bulk manufacture, will be freely available at the time it reaches market-readiness. We comment further on some of these future factors in the technology-specific appendices; however, the reader will need to keep in mind that the cost estimates presented by this document relate to currently available technology.
- Materials prices: Changes in materials prices must be passed on to the customer in the long term, but strategic purchasing of commodities or futures by the suppliers could delay price changes.

associated with returning the storage and marshalling sites to their original state on completion of the construction work.

⁷ End costs: Some transmission technologies have high construction costs associated with the ends of the circuit. This is particularly significant for HVDC, where a converter station is required at each end of the HVDC circuit. It can also be important for underground cable, where the equipment required for the above/below ground transition can cost in the same order as 1km of the underground cable itself.

- Market forces: This is a big uncertainty factor. If the market is bullish, supplier pricing may well rise, though in the longer term the price may stabilise as more suppliers enter the market. However, if the market is stagnant, suppliers could “buy” work by offering low prices, but then again, the market could also contract as they shut manufacturing lines, thus causing prices to rise.

Given all these pricing uncertainties, it is recommended that the transmission technologies, their costs, and our assumptions, are all reviewed regularly, and updated when it is considered that our sensitivity factors no longer offer the required estimating clarity.

Appendix D Losses

D-1 Introduction

The terms of reference (ToR) required that lifetime costs, including losses, be considered by this study. This appendix lists the losses that have been included by the study, and provides additional information about them.

First of all, what are losses? Let's take the example of the principal source of losses: the resistance of the electricity conductors. No transmission circuit is 100% efficient in operation.⁸ Both overhead aluminium wires and underground aluminium or copper cables, exhibit electrical resistance (measured in ohms), and when electrical current flows through these conductors they generate heat. This heating effect occurs – and has to be paid for – whether it is required (for example, in the element of a kettle) or not (such as in transmission and distribution circuits). Since it is impracticable to use the heat energy generated in these latter examples, it escapes to the atmosphere and is thus termed a “loss”.

The various transmission technologies each have their own characteristic losses. Some of these losses vary with the voltage of the transmission conductor (for example, cable dielectric losses), whilst others vary with the current being carried at any instant, such as conductor resistive losses. However, whilst dielectric losses are proportional to voltage, resistive losses are proportional to the square of the current flowing. So, for example, the rate of resistive energy loss during a period of half load, would be just one quarter of the loss rate at full load.

Corona losses are sometimes mentioned with respect to overhead lines. Except in foul weather corona losses are of a lower order than resistive losses and thus are not considered further here.

D-2 Power and energy costs

There are costs associated with all these losses, and two of the cost components are:

1. the cost of the fuel burned and of the associated operating and maintenance costs to generate the electrical energy which is lost through the transmission network (the energy loss) – this is also described as the short run marginal cost (SRMC), and
2. the capital cost of installing the extra power generation equipment to provide the above lost energy at the time of maximum power demand (the peak power loss) – this is also described as the long run marginal cost (LRMC).

These loss costs are straightforward to define and reasonably straightforward to calculate. They relate to the physical parameters of the transmission network and to the costs of the mix of generator types available in the UK. We include estimates for both of these cost

⁸ Conventional transmission circuits are subject to resistive losses, as discussed further in the text. Superconducting circuits (a technology which has not been employed on the UK transmission network to date) have been shown in development projects to avoid these losses though, unlike conventional technologies, they do exhibit cryogenic cooling losses.

components in our transmission equipment unit costs, and we discuss them in further detail in the sections below.

Before doing this, however, we mention here another type of loss cost which is gaining increasing significance – that of carbon – and this is briefly discussed next.

D-3 Carbon dioxide costs

The social cost of dealing with the carbon dioxide emissions due to our energy consumption continues to be the subject of much discussion and research, based as it is upon a variety of scientific, economic and policy uncertainties and upon ethical value judgements relating to present and future generations. It is not the remit of this study to further that discussion and research, but the latest revision of the EU Emissions Trading System (ETS) – of which the UK is a part – requires that, by 1 January 2013, the whole of the electricity generating sector be subject to the auctioning of emissions permits. This will have the effect of requiring carbon dioxide emissions to be paid for, by fossil-fuel generators, on an auction market basis.

At this stage, however, we understand that the carbon emission permits are largely allocated freely, and that carbon emissions have little cost effect upon the generators' businesses or upon electricity consumers' bills. For this reason, we consider it inappropriate to include carbon costs relating to transmission losses in this transmission costs study, and so have limited our cost estimates to power and energy losses.

D-4 Assumptions

In our losses calculations we have assumed:

- that a good estimate for the short run marginal cost of generation (SRMC) may be derived from the levelised cost of high efficiency firm capacity generation plant – we have chosen combined cycle gas turbine (CCGT) levelised costs,
- that a good estimate for the long run marginal cost of generation (LRMC) may be derived from the levelised cost of peaking generation plant – we have chosen open cycle gas turbine (OCGT) levelised costs,
- that the capacity and lengths of the transmission circuit losses studied here will be those detailed in Table 1, Page 3,
- that the system voltage is 400kV,
- that, for the purposes of calculating losses, the average circuit load on National Grid's main interconnected transmission network is 34%⁹ of the winter post-fault continuous capacity of the circuit; in the text below, this value is referred to as the circuit loading factor (CLF),
- that, for the purposes of calculating the peak power loss, the peak loading of the transmission circuit will occur at system peak, and
- that the transmission system load factor (LF) is 61%, and loss load factor (LLF) is 39%, values which have been calculated from National Grid's

⁹ The 34% CLF value is quoted by National Grid in their 2011 Strategic Optioneering Report for the proposed new Hinkley Point C connection, but it must be stressed that this value is not characteristic of all circuits, and for this reason we also test the cost of losses assuming higher and lower CLF values.

metered half-hourly electricity demands for the period 1 July 2010 to 30 June 2011 (further details of these parameters may be found below).

D-5 Method – general

Our approach to estimating the costs of losses has been to take the following steps:

- Take the assumptions, listed above, about the maximum transmission capacity required and the average loadings that will occur.
- Obtain details on loss sources presented by each transmission technology, either from suppliers' data or from first principles.
- Derive estimates for the LRMC and SRMC.
- Calculate, for each technology, capacity and route length (two circuits), the energy loss and its annual cost, and the maximum power loss and its annual cost.
- Add the annual operations and maintenance costs to the costs of losses.
- Use the discounted cash flow technique to estimate the present value (PV) of the losses and maintenance over the expected lifetime of the transmission equipment.

This procedure puts the costs of losses and maintenance on the same financial basis as the estimated capital costs for each transmission technology, so we then present the costs of losses alongside the primary capital costs to derive an overall lifetime cost for each technology/capacity option studied.

Further detail on the calculations of the power and energy losses elements discussed above is presented next.

D-6 Cost of energy losses

Energy loss refers to the heat which wires and cables of a transmission network emit during operation – the energy is just lost to the atmosphere. This heat is caused mainly by the resistance of the transmission conductors to the flow of electric current, and it varies instantaneously during the day according to the square of the electric current flow.

We have calculated the overall energy losses by summing, as appropriate for each technology, one or more of the following energy quantities (MWh) at the average load of the transmission connection:

- resistive losses (all technologies)
- dielectric losses (AC underground cable)
- sheath losses (AC underground cable and AC GIL)
- reactive compensation losses (AC underground cable)
- converter station losses (HVDC)

These are somewhat lengthy calculations, taking into account many factors including ambient and conductor temperatures, conductor resistances, capacitances, lengths and voltages, the number of conductors in parallel, and whether the conductors are suspended in air, buried or positioned under the sea. It is not proposed to detail these calculations here;

however, as an example of the results, the energy losses and peak power losses (described next) for the nine overhead line options are presented in Table 4 below.

The cost of the summed energy losses is calculated from the following formula:

$$\begin{aligned} \text{Annual cost of energy losses (£ per MWh pa)} \\ = \text{Energy lost pa @ 34\% rated load (MWh)} \times \text{SRMC} \end{aligned}$$

where:

$$\text{SRMC} = \text{short run marginal cost (estimated to be £46.60 / MWh in this case).}$$

A good estimate of the short run marginal cost may be derived from the levelised cost of the variable operation and fuel costs of high-efficiency firm capacity generation plant. We have sourced this information for combined cycle gas turbine (CCGT) plant from DECC's Electricity Generation Cost Model – 2011, updated in August 2011 by Parsons Brinckerhoff.

Table 4 – Overhead line energy and peak power losses

| OHL | | | |
|---------------------|--|----------------------|--------------------------------|
| Circuit length (km) | Post fault cont. capacity per cct - winter (MVA) | Energy lost pa (MWh) | Whole cct peak power loss (MW) |
| 3 | 1,595 | 1,208 | 0.4 |
| 3 | 3,190 | 3,326 | 1.0 |
| 3 | 3,465 | 3,040 | 0.9 |
| 15 | 1,595 | 6,038 | 1.8 |
| 15 | 3,190 | 16,631 | 4.9 |
| 15 | 3,465 | 15,198 | 4.5 |
| 75 | 1,595 | 30,190 | 8.9 |
| 75 | 3,190 | 83,156 | 24.5 |
| 75 | 3,465 | 75,989 | 22.4 |

D-7 Cost of power losses

The costs of maximum power losses are the costs of installing the extra generation necessary to supply the energy losses (discussed above) which will ultimately heat up the atmosphere. These generators must be capable of supplying the peak losses, which will occur during the peak loading of the connection. We assume, for the purpose of this study, that the peak loading of the transmission connection will be coincident with system loading peak. Consequently the losses on the transmission network will, in general, cause additional generation plant to be built to satisfy the losses load, and so they represent a real cost.

This extra power generation required for a circuit is sometimes termed the peak power loss (PPL), and we have calculated it using the following formula:

$$\text{Peak power loss (MW)} = \frac{\text{Energy losses per year (MWh)}}{\text{LLF} \times 8760}$$

where:

$$\text{LLF} = \frac{\text{Actual Losses (MWh) during a period}}{\text{Losses (MWh) that would occur if the load was at peak during the same period}}$$

= 39% in this case, as calculated from National Grid, July 2010–June 2011 demand data download, and

8760 = the number of hours in a year.

The cost of PPL is calculated from the following formula:

$$\text{PPL cost (£ pa)} = \text{PPL (MW)} \times \text{LRMC (£ per MW pa)}$$

where:

LRMC = long run marginal cost (assumed to be £90.10 / kW pa in this case).

A good estimate of the long run marginal cost may be derived from the levelised cost of the capital and fixed operation and maintenance costs of peaking generation plant. We have sourced this information for open cycle gas turbine (OCGT) plant from DECC's Electricity Generation Cost Model – 2011, updated in August 2011 by Parsons Brinckerhoff.

D-8 Note on discount rate

Discount rate can be real or current – we assumed real, so that inflation does not need to feature in the calculations.

In calculating the present value of 40 future years' operations and maintenance cost, including losses, we used a discount rate of 6.25%, which approximates to that proposed by Ofgem for the purposes of assessing rate of return on investment for transmission companies. However, we recognise that the choice of discount rate is not straightforward, so we present in the following Table 5 an indication of how our estimate of the present value of the losses and fixed operation and maintenance costs would vary with alternative discount rates.

In the following table, 'WACC' means 'weighted average cost of capital'.

Table 5 – Effect of different discount rates on operating costs

| | Discount rate | Increase in operating costs | Basis |
|---|---------------|-----------------------------|--------------------------|
| | 2.75% | 61% | Cost of debt * |
| | 3.50% | 43% | Treasury Green Book |
| | 4.25% | 29% | Vanilla WACC (post-tax)* |
| | 5.74% | 6% | Vanilla WACC (pre-tax) |
| → | 6.25% | 0% | current calculation rate |
| | 6.50% | -3% | cost of equity * |

*Note: These rates are identified in the report “Updating the Cost of Capital for the Transmission Price Control Rollover”, Ofgem – Phase 2 Final Report, Feb 2011

D-9 Load growth

The purpose of transmission system planning and system development is to maintain the existing and new circuit loads at levels which will ensure acceptable levels of security of supply. For this reason, when a circuit loading grows significantly beyond its optimum level, the network is reconfigured, or new circuits are planned, in order to return the circuit in question to more optimum loading levels.

As a result, we don’t expect significant long-term rises in the average circuit loading, and have not factored load growth into our costs of losses calculations.

Appendix E Technology – Overhead Lines

E-1 Technology description

Overhead transmission lines are designed to be capable of transporting bulk supplies of electricity over long distances, from the point of generation or network node to other nodes or distribution substations. Most transmission networks around the world are built largely of overhead line.

Overhead lines use bare aluminium alloy conductors, and operate at very high voltages to minimise operating losses. They rely upon the natural insulating properties of air except at the conductor suspension points where porcelain or glass insulators attach the conductors to the supporting structure.

Normally in the UK the support structures comprise a steel lattice tower construction, although in other parts of the world, alternatives such as folded steel plate (tubular pole) structures are sometimes used. The winner of a recent DECC-organised competition for tower designs is basically of this style.

The OHL designs employed in England and Wales remain generally robust and operational in the worst weather conditions and, even though they are susceptible to lightning strike, their automatic return to service following such an incident is normally accomplished within seconds. Even when they are physically damaged, their repair can normally be effected within hours, or just a few days. Thus, their availability remains very high, which supports the security of supply and National Grid's ability to keep the lights on.

The principal limitations of OHL relate to their space requirements, the visual intrusion on people who need to live too close to them and, for some, the concerns relating to EMFs. For these reasons, the process of routeing new OHLs has become increasingly complex and time-consuming in recent years. Public awareness of the environment and landscape heritage has meant that overhead line applications are more likely than ever before to become the subject of a public enquiry.

E-2 Civil Works and components

E-2.1 Tower foundation types

Standard foundations for towers

Standard foundations for transmission line towers normally consist of a concrete pad and column footing arrangement which is expected to perform adequately in good to moderate ground material. Pad and column foundation arrangements require open excavation to allow the pad or slab to be cast. There are a number of methods practised for the construction of the columns, the two main ones, shown in Figure 10, being inclined and stepped.

Figure 10 – Two common tower foundation designs

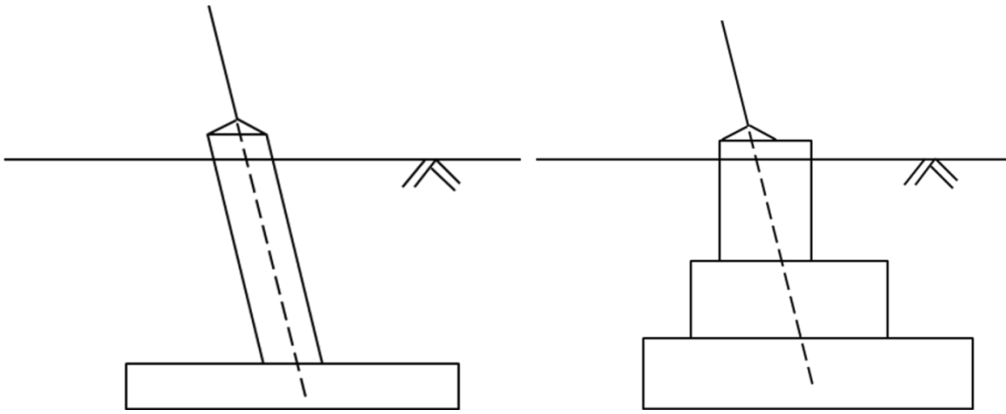

i) Pad with inclined column (pad & chimney)

ii) Pad with stepped column

Other common foundations for towers

Although, during the design process, standard foundations are anticipated in many areas, a significant number of rock foundations are also to be expected. Where sound bedrock is very near the surface, rock anchor or rock key foundations are likely to be required. Their designs are outlined in Figure 11.

Figure 11 – Two rock foundation designs

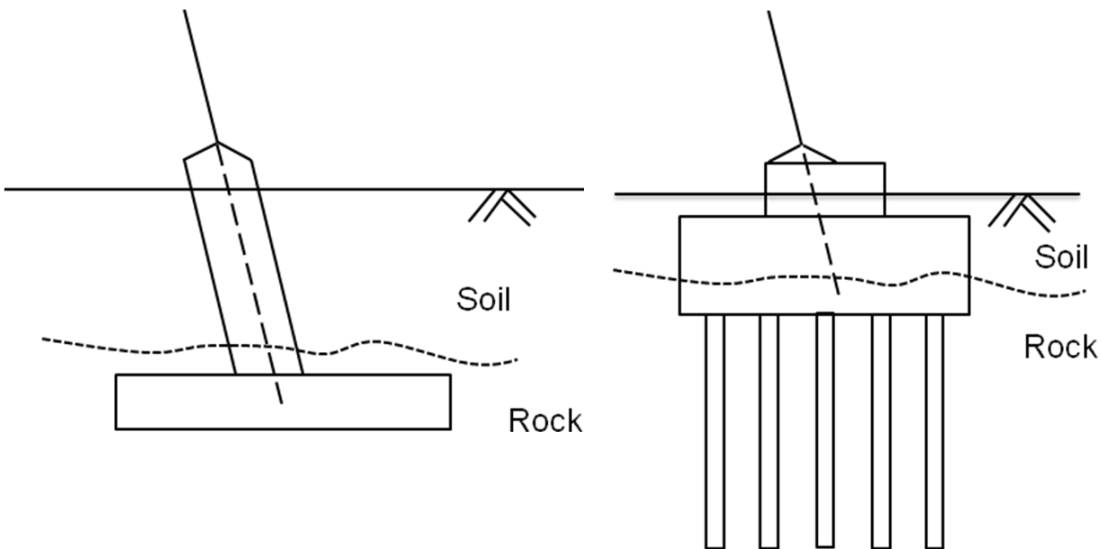

i) Rock key

ii) Rock anchor

Even when the ground material is good or moderate it may not be convenient or practical to install a standard footing. In many instances, it is quicker or easier to install other types of foundation such as pile or caisson. With suitable designs in place, this option may be employed at the discretion of the contractor and may even be applied instead of rock

foundations if the formation is sufficiently weak. This type of foundation has distinct safety advantages as it negates the need for personnel to access open excavations.

Depending upon the ground conditions and access, piles may be augered or driven.

Caisson foundations are open tubes or boxes which may be later in filled with concrete or other suitable material. Caisson tubes and boxes may be prefabricated (e.g. precast concrete) or cast in situ. These foundations will perform similarly to auger piles. Two examples are depicted in Figure 12.

Special foundations for towers

In locations where poor or troublesome foundation material is unavoidable, special foundations are normally required. In particularly difficult or unusual circumstances bespoke designs for the special foundations may be needed. Some potential special foundations and indicative bespoke designs are shown in this section.

Figure 12 – Driven and augered pile foundations

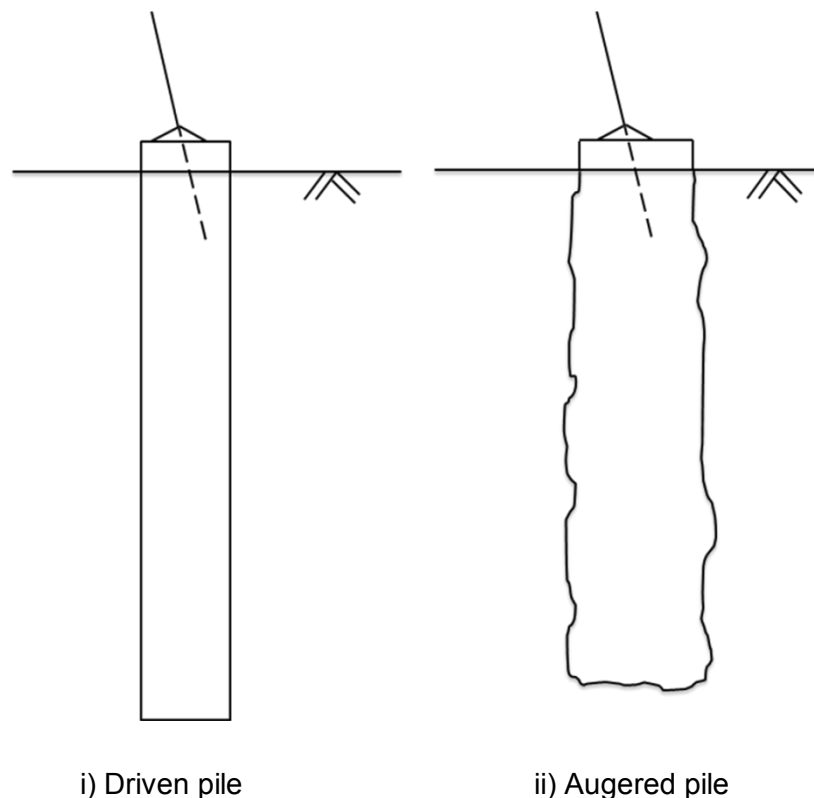

At locations where particularly poor soils are encountered both bearing and uplift capacity are a problem for new foundations. In these instances the uplift and bearing loads can be reduced by extended pads or rafts. An example of a raft foundation is shown in Figure 13.

Figure 13 – Raft-type tower foundation

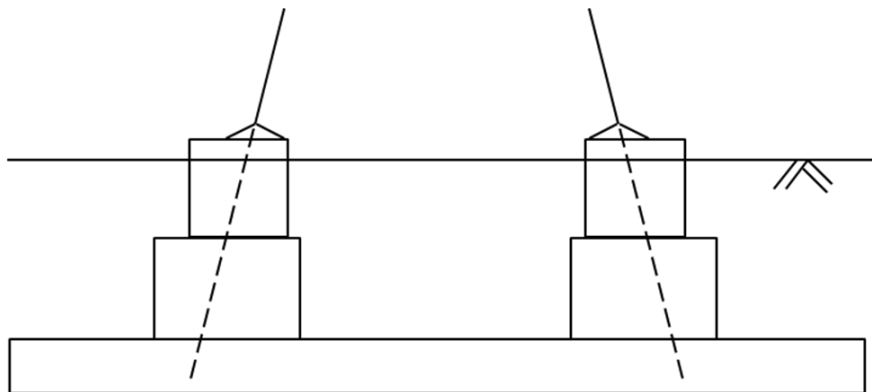

Pile and caisson type foundations are particularly useful for installation on steeply sloping ground where landslides and slope failures may occur, as the founding depth can be such that it extends below the failure slip plane. An example of a pile or caisson foundation installation in unstable sloping ground is shown in Figure 14.

Figure 14 – Pile or caisson foundation in unstable ground

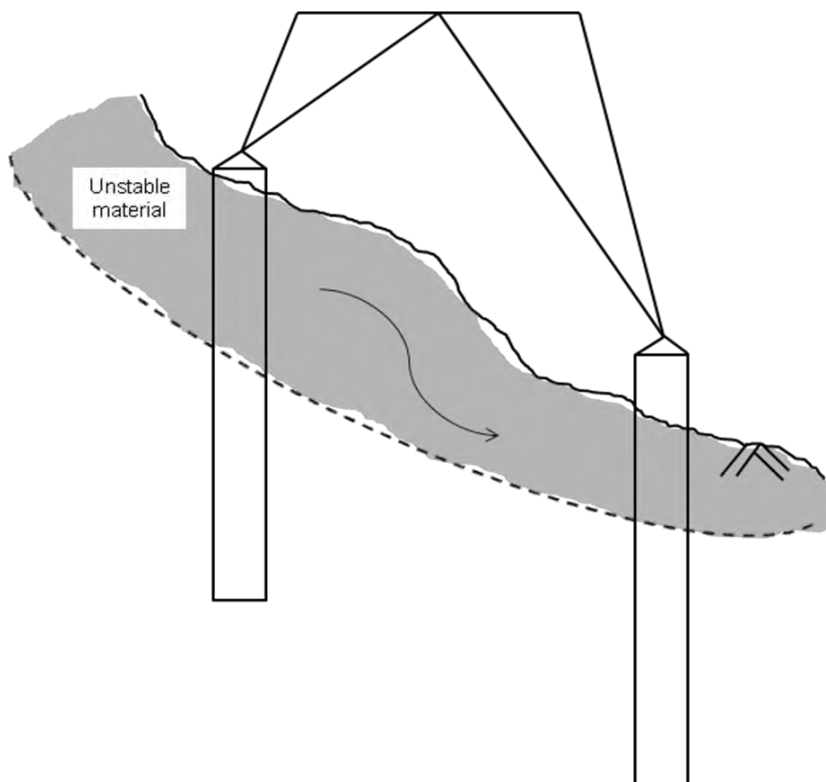

Where towers are located near rivers with high energy scouring, undermining of the foundations can be a problem. In these instances, special piled foundations such as that shown in Figure 15 may be successfully employed. The level of the connecting beam and pile heads supporting the tower can be raised where flooding and wash debris also pose a risk to the tower. Figure 15 shows an example of this type of construction,

Figure 15 – Pile and beam foundation for flood-plane use

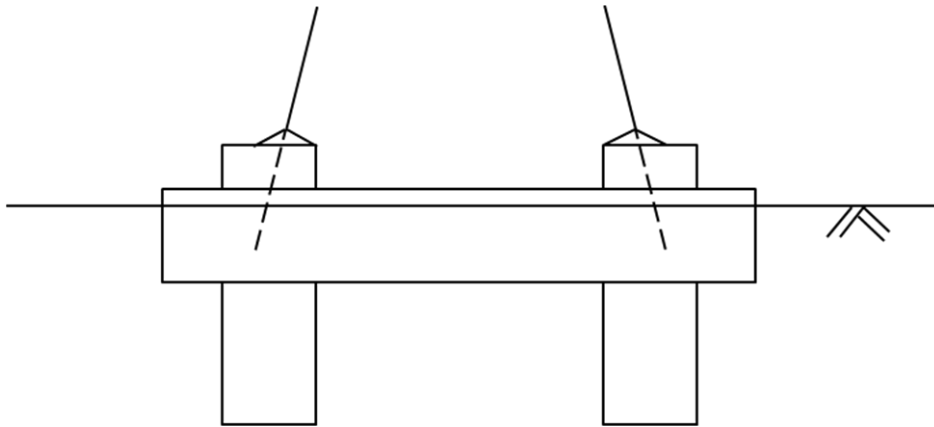

In addition, various types of pile foundation are frequently used for transmission tower foundations including steel tube, continuous flight auger and micropiles.

Comparison of UK and EU foundation technologies – cost implications

The practices and technologies used across Europe vary due to construction tradition, design preferences, land law rules of the territory, and local material costs, along with routing complexity.

We do not presently see any significant cost reduction advantage in the adoption of these technologies for use in the UK.

E-2.2 Tower types

Transmission towers in the UK are generally of a lattice steel structure, with the number of cross arms varying with the configuration. Tower design strength and size are dictated by the line voltage and electrical air clearances, insulator string lengths and the weight, diameter and number of conductors employed for each phase, and the environmental conditions. The type, size, height and spacing of towers are determined by geographical, operational, safety and environmental considerations.

A typical overhead line uses three elementary types of tower:

- suspension (used for straight line sections)
- angle (where the route changes direction)
- terminal (where the lines connect with substations or transition to underground transmission technology)

Even for straight-line routes an angle tower is normally used approximately every 10 spans to prevent a “cascade collapse” in the very rare event of catastrophic collapse of a suspension tower.

A 400kV double circuit suspension tower is typically 40 to 60 metres high, with a width of between 17 and 32 metres, depending on tower type. The two principal types are:

- the “vertical configuration” (the most commonly used design in the UK) which narrows at the top, and

- the triangle-shaped “Danube” design towers.

Other designs are currently being considered by National Grid with a view to reducing the visual impact of the transmission line structure.

These two designs are depicted in Figure 16.

Advantages and disadvantages of the vertical and Danube type structures

Table 6 summarises the differences between these two tower types:

Table 6 – Vertical vs. Danube tower comparison

| Vertical arrangement | Parameter | Danube arrangement |
|-----------------------------|---------------------------------|---------------------------|
| + | Horizontal footprint (corridor) | - |
| | | width + 10m |
| - | Tower height/ visual impact | + |
| +10m more | | 10m less |
| - | Tower weight/price | + |
| 10–15% heavier | | 10–15% lighter |
| - | Transposition simplicity | + |
| special tower needed | | in span transposition |

Figure 16 – The vertical configuration (left) and Danube towers

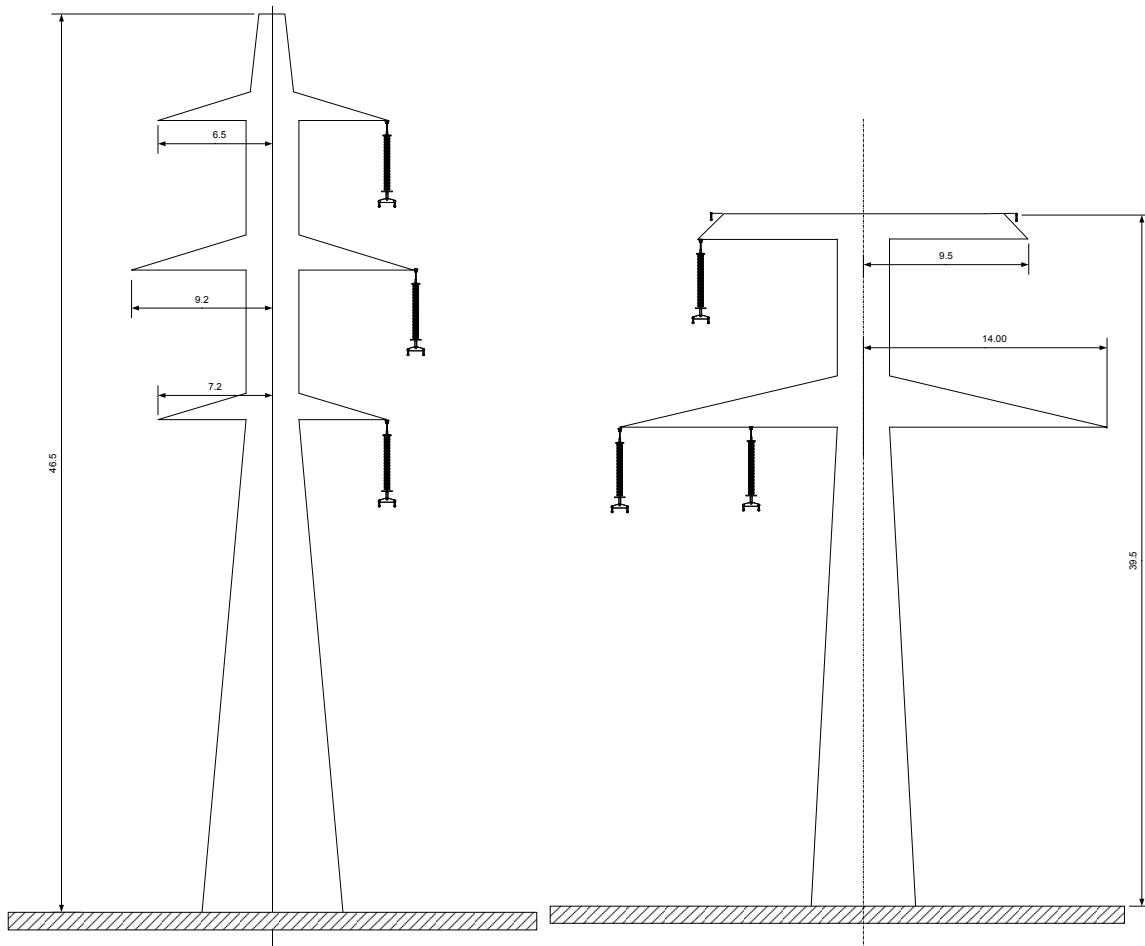

For 400kV, towers are usually spaced around 350 to 450 metres apart and provide ground clearance of at least 7.5 metres (recently increased to 8.1m to meet European Union requirements) in all weather conditions. Higher clearances usually apply if the route crosses motorways, navigable waterways or railways.

Whilst towers for 400kV are typically made of traditional galvanised lattice steel, other proven designs are available. Conical towers are made of high strength folded steel (tubular poles), but are rarely used at the 400kV level due to certain existing technology limits and higher costs.

Most of the current UK designs were developed in the late 1960s and early 1970s and, except for some minor aesthetic modifications and metrification, have remained unchanged until now. Over the last couple of years, however, and following the development and issue of unified EN standard (EN 50341) and its NNA (National Normative Aspects), tower designs used for new lines have needed some strengthening because the mechanical loading conditions specified by the new standard are more stringent.

EU towers

Utilities across the EU use a variety of lattice steel tower types and shapes. These include double circuit towers similar to those in the UK, the triangle shaped Danube configuration

(Central Europe), a horizontal “double decker” configuration (France), and multiple circuit towers with a variety of different arrangements. Scandinavian utilities use predominantly simple construction single circuit towers, some of them as guide structures. Installations on single circuit lines can be seen in countries with vast open spaces but, except in the above mentioned Scandinavia example, their use is now limited by land use regulations.

It is worth mentioning the trend (in some countries only) of building multiple circuit towers of up to eight circuits of different voltage levels, or up to four circuits of same voltage level (400kV). These structures are perfectly fit for congested urban areas with very low availability of free corridor but there are some limitations regarding the maintenance, and the visual impact is significant.

Another design, folded steel single poles with curved tubular cross arms, is predominantly used in France. Some consider its visual impact to be lower than that of the lattice design, but there are mechanical load limitations which dictate the maximum size and number of conductors, which cause its use for voltages above 220kV to be limited.

Comparison of UK and EU tower technologies – cost implications

UK towers, as originally designed, were very heavy, and their diagonal ground level spread (footprint) was extremely high too.

E-2.3 Conductors

The conductors used on 400kV transmission lines are usually made from aluminium or aluminium alloy with an equivalent cross-sectional area of 300–850mm². Due to the mechanical behaviour of aluminium wires, many designs of aluminium conductor are reinforced with steel to withstand inclement weather conditions including ice, frost and wind. This type is known as aluminium conductor, steel reinforced (ACSR) and was widely used from the 1960s. The ACSR conductor is being replaced by the all aluminium alloy conductor (AAAC). The AAAC is favoured due to its high performance mechanical and electrical properties, lower weight, decreased sag, simpler dead end and mid span joints and its better resistance to corrosion.

In the past decade, in an effort to increase the capacity of existing overhead lines, other more complex conductor constructions, for example, GZTACSR “Gap”, or aluminium conductor with a high-strength composite core, have become popular amongst the European utilities. It is worth noting, however, that whilst these conductors raise the capacity of the line without having to build new towers, the losses also rise significantly. This is just as you might expect, bearing in mind that these conductor designs achieve their aim by being able to run hotter than the conductors they replace.

UK towers are designed to carry a double circuit of three phases each. Each phase can comprise between two and four conductors (twin, triple or quad bundles). The number of conductors per phase depends on the technical requirements. Strategic selection of conductor bundling is used to improve the line capacity, to prevent corona discharge, and to reduce audible and radio noise and line losses.

In addition to the phase conductors, transmission lines in England and Wales have one or two earth wires to protect the line from lightning strikes. These wires usually also carry optical communication fibres embedded inside the earth wire, in which case they are often termed optical fibre ground wires (OPGW).

E-2.4 Insulators

The electrical conductors of the transmission line need to be insulated from the ground. Although overhead lines use air as their principal insulator, the live conductors are hung from the towers with cap-and-pin strings of toughened glass or porcelain. An alternative to these traditional materials is the composite insulator design. These are cheaper than the traditional materials, and have a good track record in Europe, as a result of which, they are slowly gaining ground now in England and Wales.

The length of the insulator strings depends on line voltage and surrounding environmental pollution levels.

E-2.5 Other overhead line equipment

Other equipment that is used on transmission lines includes:

- vibration dampers, which are fixed to conductors to avoid conductor damage in windy conditions,
- spacers, which maintain conductor separation at intervals along the span between towers,
- clamps, and
- jumpers and joints.

E-3 Application of the technology

Overhead transmission lines have been used extensively throughout the world to transmit bulk supplies of electrical energy over long distances. They offer an effective low-cost solution to the problem of bulk power transfer, not least because they have a low electrical impact upon the rest of the transmission network. However, they are bulky, and so are most often located in rural locations. Whilst it would be extremely difficult to locate a new transmission line in built-up areas, there are a number of locations where buildings have been located beneath, or very close to, existing overhead lines.

E-4 Environment and safety

Overhead lines have their own specific ways of impacting the environment. Whilst the scope of this report does not include a study of social or environmental impacts, we recognise that there are potential effects from each of the technologies, and have provided an indication of the most likely potential effects in Appendix L - Planning and Environment.

Regarding construction practices in the UK, safety of the construction team and of the public is of primary importance. In order to gain safe access and egress from the highway when building overhead line towers, quality access roads/entrances are provided which:

- minimise land damage,
- allow safe off-highway access,
- may be required by consent condition from the Secretary of State to enable wet weather working without land damage,
- facilitate year round build, and

- are required for crane build – safest method, if adequate access practicable.

Access roads are usually not removed because the landowners tend to prefer them to remain in situ. Total access road lengths are normally roughly equivalent to overhead line route lengths, though access road lengths can increase well above this in less accessible terrain.

Another safety feature normally employed in the UK is the scaffolding of road crossings to ensure safety without closing highways.

These safety measures are not cheap, though it is beyond the scope of this study to investigate whether there could be cheaper alternatives.

E-5 Cost make-up

The following list identifies the key components that go to make up the cost of a new overhead line in the UK. These items are provided in the pie charts of the OHL lifetime costs in the main body of the report.

| AC overhead line | |
|-------------------------------------|--|
| Mobilisation extras | Total of fixed construction costs including establishment of site office |
| Total fixed build costs | A |
| Foundations total | Cost of materials, plant and labour to establish the four foundation pads and steel stubs |
| Tower materials | Steelwork – rolled, drilled, galvanised, and delivered to site |
| Conductors + OPGW materials | Twelve (or 18) route-lengths of conductor drummed and delivered to site – also, one route-length of OPGW, and joint boxes where needed |
| Access roads total | Establishment of access roadways, including materials, plant and labour – also includes necessary improvements to highway turn-ins, gates and gateways and management of topsoil, and reinstatement following construction, if required by the landowner |
| Insulators + fittings materials | Insulator strings, steel and aluminium conductor fittings, all delivered to site |
| Erection of towers + stringing | Labour and plant to erect towers and string the insulators – includes crane at tower location |
| Engineering and safety | Site-based engineering, management, and safety arrangements to protect staff, contractors and the public – all work associated with design, CDM compliance, health and safety regulation compliance, construction wayleaving and access permissions |
| Project launch and management (10%) | Early designs, application for consent, project management |

| | |
|---------------------------------------|---|
| AC overhead line | |
| Build contingency (10%) | A sum to cover small items that normally arise but which are too small to list, or have high uncertainty on them |
| Total variable build costs | B |
| Total build cost | C = A + B |
| Cost of power losses (power stations) | Costs associated with having generating plant available to generate the energy losses (described further in Appendix D) |
| Cost of energy losses (fuel) | Costs associated with the fuel burned in the power station to supply the conductor losses (described further in Appendix D) |
| Operation and maintenance | Route patrols and inspection, vegetation management, tower painting and other work needed to retain the serviceability of the OHL |
| Total variable operating costs | D |
| Lifetime cost | E = C + D |
| | |

E-5.1 Parsons Brinckerhoff budgetary cost database

The OHL cost make-up for this study is derived from a variety of sources including a PB database, data published by CIGRÉ and the European Union, and specific requests for data from a variety of sources.

Database

For many years, PB has maintained a database of transmission line costs from projects around the world. The data has been maintained in such a manner as to permit interpolation of costs for different constructions and for the use of different conductor sizes and arrangements.

In various regions of the world, it has been found that overhead line costs depend upon basic market factors such as the amount of available work and the numbers of contractors and manufacturers/suppliers willing to participate in the work.

Costs from this database have been built up assuming “average” line routes and difficulties of construction, which corresponds approximately with the case studies described in Appendix C.

E-5.2 CIGRÉ and European Union

In conjunction with the database, PB has also taken account of data published by CIGRÉ on the breakdown of transmission line costs¹⁰. The CIGRÉ data shows that material costs

¹⁰ “Parametric Studies of Overhead Transmission Costs” – CIGRÉ Working Group 09 (Overall Design) of Study Committee 22 – Published in Electra No.136 dated June 1991

normally make up 65% of the total line cost, with the remaining 35% comprising construction costs. Similarly, the total material costs may be broken down into the costs for each of the main components of a transmission line. The most quoted typical example of the main components breakdown for an “average” line route is as follows:

- conductors 32%
- earth wires 4%
- insulators 8%
- towers 36%
- foundations 20%

For a double circuit transmission line operating at 400kV, with twin or triple bundle AAAC conductors and one OPGW (optical ground wire), our estimated base OHL cost is for an average transmission line in the UK on flat or gently undulating land, based on recent England/Wales construction data, 2011 Q4.

E-5.3 Engineering, project management, and CDM regulations

Project management (PM) costs presented here are typical for the approaches taken, grade of resource required etc. However, PM costs for capital projects within the industry are generally within the 2.5% to 4% band, dependent upon type and scale of project. Costs associated with implementing CDM regulations are difficult to assess, primarily as the total costs are not picked up by any one party. The associated costs to ensure compliance with CDM are normally hidden amongst the inherent costs to comply with statutory health and safety issues in general.

E-5.4 Estimated EPC contract costs

The estimated route lengths of the proposed transmission lines have been taken as 3km, 15km and 75km. Typical 400kV overhead line designs are represented by the following conductor /tower combinations:

- 2x Sorbus AAAC on L8 towers
- 2x Redwood AAAC on L12 towers
- 3x Araucaria AAAC on L6 towers

E-6 Cost sensitivities

This section identifies the key factors to which the estimated prices are sensitive, and provides typical ranges within which the costs could vary, all else being equal.

E-6.1 Base metal price escalation

In the past 10 years, the price of raw materials has fluctuated significantly, and has not mirrored the overall economic inflation. For example, Figure 17 shows the aluminium price per tonne from 2001 to 2011 (see Appendix M, item 7).

Figure 17 – Aluminium price per tonne

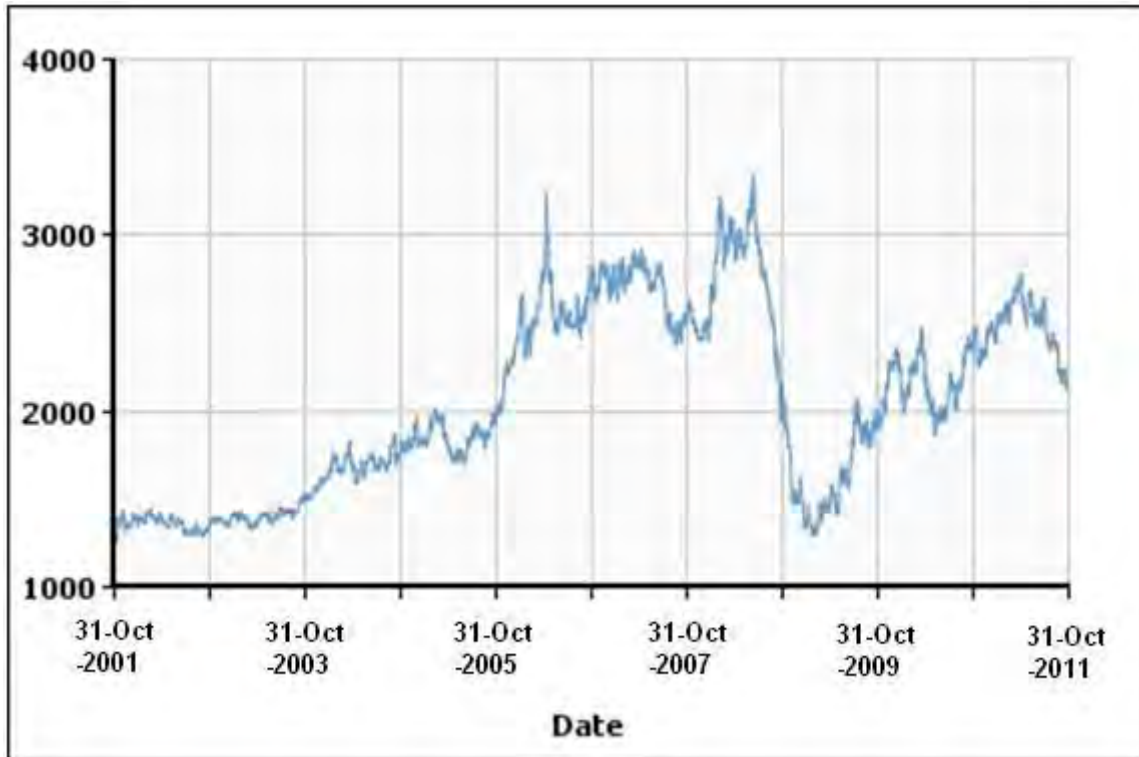

From the CIGRÉ reference¹⁰ it is clear that aluminium or aluminium alloy conductor material represents 32% × 65% of the total cost = 21% total costs, although that percentage has not necessarily been representative of recent England and Wales contracts.

The price of tower steel represents not only the raw material costs, but also the materials and labour involved in forming, drilling, galvanising and transporting the product to site. Of this, labour (galvanising treatment, transportation and other costs) forms around 50% of final fabricated steel tower price. The costs of galvanising are highly dependent upon metal price + price of energy, and the escalation of the price of hot dip zinc treatment was reported to have a volatility ±250% over the past 11 years. However, it should be noted that fabricated steel pricing is dependent on market positions and upon foreign exchange rates – particularly the US dollar rate, and the final negotiated price for a given contract may differ significantly from the “expected” mean.

E-6.2 Impact of HV line route terrain

Where a line route crosses poor ground conditions, both access and foundation construction costs will be higher than the costs for “average” ground conditions. Where poor ground conditions require special access works or vehicles, and piling is required for the foundations, the cost of foundations and associated access works for a tower can rise by a factor of between 5 and 10 compared with the costs for normal ground conditions.

The new-build costs in this study assume that 76 per cent of the towers are of the suspension type, and that basic span capacities are utilised to 82%. These percentages can be taken to be typical of an overhead line through partially open, semi-rural or semi-urban land, and undulating terrain with reasonably flat sections. For lines through hilly terrain or through densely populated areas the suspension tower percentage can decrease to 50% and span utilisation to around 60%, with consequent significant cost increases.

E-6.3 Impact of line length and significant crossings

Mobilisation costs form a significant part of the construction costs, particularly where the line is shorter than 100km. Additional costs are incurred at crossings of national railways or motorways. Apart from the extra cost of the higher towers that may be required, safety scaffolding for such a crossing could run into hundreds of thousands of pounds each.

E-6.4 Summary of cost sensitivity parameters and ranges

- Ground conditions:
 - (i) drained arable provides ideal ground for overhead lines: base case
 - (ii) wet peaty ground incurs extra cost due to difficulty of access for heavy construction plant plus the need to pile foundations: +16% to +24%
 - (iii) unstable/mined/quarried ground requires larger and deeper tower foundations to avoid subsidence during operation foundations: +24% to +48%
- Route directness:
 - (i) on average 7.5 towers per route deviation: base case
 - (ii) on average 5 towers per route deviation: +10%
 - (iii) on average 3 towers per route deviation, and higher than standard towers: +17%
- Terrain:
 - (i) flat arable land, no change in height: base case
 - (ii) rolling hills, typically extra 3m height: +5%
 - (iii) urban terrain, typically extra 6m height: +11%
 - (iv) large river crossing and associated structures: +60% to +100% (not including exceptional crossings such as West Thurrock or the Severn)
 - (v) span utilisation due to difficult terrain each: -10% to +4%
- Capacity:
 - (i) 2 × 850 AAAC @ 90°C: base case
 - (ii) 2 × 570 AAAC @ 90°C: -14%
 - (iii) 3 × 700 AAAC @ 75°C: +12%
- Tower design:
 - (i) standard: base case

- (ii) low height: +2%
- Aluminium commodity price (LME) + foreign exchange:
 - (i) aluminium LME base rate US\$2300/ton: base case
 - (ii) each +10% over LME base rate: +3%
 - (iii) USD to GBP exchange rate 1.59: base rate
 - (iv) USD to GBP exchange rate each: -10% to +2%

E-7 List of costing sources

This section outlines the sources of each of the above-described costings and cost sensitivities. It describes the levels of confidence that may be placed in the figures that contribute to the costing estimates for this technology.

Sources of material costs:

- towers
 - Mitas, Turkey (not currently supplying the UK, but supplying into the EU market)
- strings/insulators
 - Sediver, France
 - Lapp, Germany
 - Mosdorfer, Austria+UK (currently supplying NG)
- conductors
 - Midal, Bahrain (UK supplier)
 - Sterlite, India (supplying German market)
- OPGW
 - Prysmian (UK supplier)

Source of UK construction costs:

- Balfour Beatty Utility Solutions (written)

Source of EU construction costs:

- three European utilities – to be kept anonymous – verbal only

E-8 Anticipated future developments

This section identifies any developments known to the authors that are likely to come to the market in the short or medium term and that may have a significant impact on future transmission costs.

- **T-Pylon design** – in October 2011 the T-Pylon design was announced as the winner of a transmission pylon design competition run by the UK's Department of Energy and Climate Change (DECC). Some 250 entrants took part in the competition, and National Grid has announced that it will look at the practicalities of adopting the T-Pylon design and two others from amongst the five runner-up designs. No detailed costings have been

prepared at the date of completion of this report, but initial impressions are that the adoption of this design would affect the cost of overhead line towers by between +20% and +35%. If this was the case, then T-Pylons would represent an increase on the unit cost of overhead line transmission of between 6% and about 10%.

- **ACCC conductors** – National Grid first installed aluminium composite core conductors (ACCC) in 2010. ACCC conductors have the potential to double the existing OHL capacity and, on new OHL installations, this solution could avoid future redevelopments. Adoption of this design would affect the cost of overhead line conductors by between +100% and +120%, which would represent an increase on the unit cost of overhead line transmission of between 22% and about 27%.
- **Composite insulators** – National Grid first installed composite insulators in 2010. Full adoption of this design would affect the cost of overhead line insulators and fittings by between -25% and -45%; this would represent a decrease on the unit cost of overhead line transmission of between 2% and 4%.

Appendix F Technology – Underground Cables

F-1 Technology description

Underground cables have, for many years, been the only alternative to overhead line, and there has always been a great deal of interest in the difference in cost between the two technologies.

The cost differential between overhead line and underground cable is still significant for high-power extra high voltage (EHV) systems and we consider that it would be useful for the reader to have access to the details of constructing an underground cable system in order to be aware of what is involved. As a consequence we make no apology for the fact that this underground cable system technology appendix is longer and more detailed than any other technology description in this study.

All forms of high voltage power transmission over long distances must have at least four main components:

- one or more conductors to carry the electrical current
- electrical insulation to maintain the conductor at a raised voltage level
- connections capable of combining lengths of manufactured conductor together for installation and or repairs
- conductor terminals or terminations which may be assembled on site and allow access to the conductor at the end of the connection. This access is required to send and receive the transmitted electrical current and apply the driving voltage.

The common performance requirements of electric power transmission over long distances are:

- that the type of technology employed is capable of being installed between remote points across the intervening terrain,
- that the technology is routable in that it need not be installed in a straight line,
- that the technology employed is capable of being made safe in all areas where it is used, particularly those that are in located in publically accessible areas. and
- that the technology must have a useful service life of several decades (a service life of 40 years is generally the default requirement for the UK transmission system).

Power cables meet all the requirements above but have the following additional characteristics:

- They are flexible and able to be bent during installation without the need for additional connections (joints).

- The distance between each joints is primarily limited by the length of cable that may be transported on a drum.
- Cables of differing design may be installed in the ground, in air, in tunnels, in ducts, under roads or under water.

The most appropriate cable system technology for this 400kV study is cable insulated with extruded, cross-linked polyethylene (XLPE). XLPE cable has the benefits of:

- low energy loss
- solid insulation that does not require impregnation with insulating fluid and consequently a) risk of leakage into the environment is eliminated, b) maintenance is reduced and c) risk of fire spread is reduced.

For underground or tunnel installation, XLPE cable is preferred to the alternative designs of cable, which include the self-contained fluid-filled (SCFF) type; this type is also known as oil-filled cable. The number of applications and suppliers of SCFF cable is presently falling to a level where it is foreseen that it will soon become obsolete for land cable applications. The suitably trained and experienced personnel and the specialist equipment which would be required for an SCFF cable system will consequently become increasingly difficult to obtain. There are also environmental concerns regarding possible leakage of insulating fluid from SCFF cable systems. SCFF land cable systems are therefore not considered further for the purposes of this study.

F-2 Power cable components (XLPE)

A diagram of a power cable used in the transmission of large amounts of electrical power is shown in Figure 18.

F-2.1 Conductors

EHV transmission conductors are made from either copper or aluminium. Solid or stranded aluminium conductors are available, but for the high power transmission requirements such as those required by the terms of reference, stranded copper conductors are required due to copper's lower electrical resistance. Depending upon metal prices, this normally allows a more economic number of cables to be used for the connection. The strands of a copper conductor may also be surface treated (e.g. by oxidation or enamelling) to reduce the conductor's AC resistance.

For high power connections the conductors consist of a number of individual wires, stranded together into conductor segments (six segments is typical), which are twisted together to form a circular conductor. This geometric arrangement of conductor wires is designed to further reduce the conductor's AC resistance.

As AC conductors become larger there is a diminishing return on their current carrying capacity. Large conductors are also difficult to manufacture and handle due to the conductor's weight, the large number of wires to be stranded together, and its minimum bending radius. For EHV transmission cable the conductor size range is generally between 500mm² and 2500mm². Although 3000mm² conductors are available on the market, they have a limited economic application but may be considered for applications requiring the highest continuous double circuit rating of the study at 6930MVA.

Figure 18 – Diagram of a 400kV transmission power cable



(Courtesy of Sudkabel)

For buried cables it is advisable to use a water blocked conductor design. Conductor water blocking limits the extent of any water ingress into the cable should severe damage occur (for example due to a fault). During manufacture the conductor wires are compacted together with a water blocking tape or powder. The water blocking agent is designed to swell up when in contact with moisture and prevent water penetrating for hundreds of metres along the cable. This water penetration can be rapid, particularly in an area where the cable is installed below the water table.

When cable conductors are connected together it is necessary to remove both the conductor wire coatings and the water blocking agents at the jointing position prior to assembling the joint or termination. This is necessary to ensure a good electrical connection between one conductor and the next at the joint position. If this is not achieved the connection will overheat and damage the joint.

A full radial and longitudinal water blocked cable design is thus preferred for a buried installation to limit the extent of any water penetration into the cable in case of cable damage.

Where cables are installed in a dry tunnel water blocked conductors may be unnecessary. However, flooding and or other means of water inundation such as water main bursts, tunnel sump pump failures or fire fighting may provide sufficient risk for water blocked conductors to be used.

The conductor within a cable carries the flow of electrical current. As the current flows through a conductor (which is not a superconductor) heat is generated and as a result the conductor temperature increases. This temperature must not rise above the maximum temperature which the insulation can withstand; as the insulation is in contact with the conductor. For modern XLPE insulated cables this insulation temperature limit is generally agreed by engineers to be 90°C.

Buried cable circuits do not receive the benefit of air cooling unless they are installed in a tunnel. In order to meet the continuous current rating of an overhead line a cable circuit may need more conductors than an overhead line.

For the 400kV transmission voltage considered in this report, one high voltage conductor is contained within one cable; this is known as a single core cable.

Insulation and screens

The insulation is extruded onto the conductor along with two semi-conducting screens. This is achieved using a multi-headed extrusion die where the screen and insulation compounds are injected into a die simultaneously along with the conductor.

The innermost screen is the conductor screen. This screen consists of a semi-conducting compound designed to electrically smooth the surface of the conductor and thereby presenting an unblemished surface to the insulation.

The XLPE insulation consists of thermoplastic polythene molecules which have been cross-linked to produce a thermosetting material. The non-cross-linked polythene and the cross-linking agents which are to form the insulation are extruded at high temperatures and pressures. This process must be completed under clean and controlled conditions to prevent gas cavities, material contamination, screen blemishes and conductor eccentricity, any of which may adversely affect cable performance.

Following extrusion the cable must undergo a period of degassing. During this process the cable is heated in an oven for several weeks to remove a substantial percentage of the by-products of the insulation cross-linking process. These by-products must be removed from the insulation if the desired service life of the cable is to be achieved.

At room temperature, XLPE is a white translucent polymer capable of operating at temperatures up to 90°C. Research organisations are active in studying the performance of XLPE materials above 90°C. However, at around 105°C, XLPE changes its crystalline state and becomes a transparent soft and flexible material. It is current practice to limit the temperature of XLPE insulated EHV cables to 90°C under normal operating conditions so as to avoid this change of state.

It is essential that XLPE insulation is kept free of water when used on extra high voltage (EHV) cables. If water is allowed to come into contact with the insulation the high electric stress in the cable causes tree-like degradation patterns (water trees) to grow, which

gradually destroy the properties of the XLPE insulation and ultimately result in electrical failure.

The outer insulation screen consists of a semi-conducting compound which is designed to electrically smooth the surface of the outer earthed sheath to present an unblemished surface to the insulation.

F-2.2 Metallic barrier and screening wires

EHV transmission voltage cables require a moisture-impermeable metallic barrier around the insulation screen. A number of alternative designs for the metallic barrier have been offered by manufacturers. These may be broken down into two categories: a) seamless and b) seamed.

Prior to the application of a metallic barrier, semi-conducting protective cushioning and water blocking tapes are applied. In addition, outer screening wires may also be applied to meet the charging current and fault current carrying requirements for the system along with further cushioning and water blocking semi-conducting tapes. This wire screen is usually made of copper or aluminium and called a copper wire screen (CWS) or an aluminium wire screen (AWS).

Seamless metallic barriers (sheaths) are extruded from either lead alloy or aluminium. The manufacturing equipment required to apply these sheaths is large and expensive for manufacturers to install, maintain and operate. Lead sheaths are the most common type of seamless metallic barrier being used for both underground and subsea applications. Extruded sheaths also have excellent water tightness and are considered to be more mechanically robust than seamed constructions.

Seamed metallic barriers consist of a flat metal strip or foil applied longitudinally, with the longitudinal seam being brazed, welded or overlapped and glued. The manufacturing equipment required to apply this type of metallic barrier is less expensive to install, maintain and operate than a seamless design. Manufacturers offer a number of alternative materials for the seamed sheath including aluminium, copper and stainless steel. Cables with seamed barriers are generally lighter and less expensive to manufacture than seamless metallic sheathed cables. Some manufacturers offer seamed barriers that use a thin metal foil with the seam being overlapped and secured by means of an adhesive.

Lead sheathed cables are capable of being manufactured by most, if not all, EHV cable manufacturers.

Seamed sheath cables using a thin longitudinally applied welded aluminium sheath are now offered by both of the world's largest cable makers (Prysmian of Italy and Nexans of France). This design of cable sheath has also been installed in England on National Grid's system.

F-2.3 Oversheath

A polymeric oversheath is applied over the metallic barrier. The oversheath material is a thermoplastic and is slightly permeable to moisture. High density polythene is the preferred material of choice as it offers good mechanical penetration resistance at high installation temperatures and thus reduces the incidence of damage during cable laying.

However, the fire performance of polyethylene is poor and for “in air” installations a fire-retardant coating, an alternative material (such as PVC or a halogen-free equivalent material), or a co-extruded fire-retardant compound may be used.

It is usual to apply a conductive layer on the outside of the cable either as a co-extrusion or as a graphite paint layer to allow DC testing of the oversheath to confirm integrity both after manufacture and laying.

F-2.4 Bending performance

The installation bending radius of a cable may be as low as twelve times its diameter (12D). Such a small bending radius should only be used at positions where formers are used to constrain the cables from further bending.

For installation in a cable trench a minimum bending radius of 20D may be employed. Usually cable installers prefer to install the cable with a bending radius of 30D or above, as this eases the pulling forces required to install the cable.

F-2.5 Cable system accessories

There are three main types of accessories:

- joints
- terminations
- earthing and bonding equipment

Joints and terminations are, electrically speaking, the weakest points of a cable system.¹¹ This is due to the high electrical stress control requirements of accessory designs (particularly on large conductor cables) and the need for accessory component assembly on site.

In operation, thermo-mechanical forces act upon an accessory as the cable conductor expands and contracts with temperature. The high reliability required of a joint or termination will depend upon a fully tested manufacturing design, a specialised manufacturing process, a fully considered installation design and a high standard of accessory assembly.

The design of an accessory will have been the subject of long-term reliability testing. Components will also have passed factory manufacturing tests.

Accessories are assembled onto the cable on site without the controlled environment of a factory. Reliable performance on EHV accessories therefore requires skilled jointers, specialist tooling and a suitably prepared jointing environment.

In order that the cable system as a whole carries a manufacturer’s warranty of between one to ten years, almost invariably a manufacturer will insist that their trained personnel assemble each accessory.

¹¹ “Update of service experience of HV underground and cable systems”, Technical Brochure 379, CIGRÉ, Paris, April 2009.

F-2.6 Joints

In order to increase the reliability of the system, it can be advantageous to increase the cable section lengths and reduce the number of joints as part of the overall design solution.

Cable joints connect together separate drum lengths of cable to make a continuous electrical connection. Each cable manufacturer will offer their own design of joint. The main components of a joint are:

- the conductor connector
- the insulation and stress control
- the radial water barrier
- the outer protective covering
- partial discharge detection devices.

The conductor connector is required to allow the flow of current between one cable conductor and the next. This connection is overlaid with factory-prepared insulation in the form of either one- or three-piece joint insulation mouldings which are applied by the jointer on site.

A metal shell is used to maintain continuity of the cable's outer sheath (or metallic barrier) and screening wires, to allow the connection of any bonding cables. The metallic shell also provides a water barrier to prevent water entering the joint.

Figure 19 – EHV joint bay containing three Joints



(Courtesy of Prysmian Cables and Systems)

Figure 19 is a photograph of three joints in a 400kV cable joint bay during the process of backfilling.

The joint is enclosed in an outer protective covering which has sufficient electrical insulation to allow routine cable overshoot and joint protection testing to be performed (10kV DC at commissioning, 5kV DC thereafter). The joint protective covering is also designed to withstand ground surface loadings (typically 5 tonnes/m²).

The method of detecting partial discharge within a joint varies from one manufacturer to another. The favoured method is currently to place sensors within the joint. These are used to detect incipient failure within the joint in order that a fault in service may be avoided. Partial discharge is a phenomenon which has often been found to be a precursor to electrical failure. Detection of partial discharge at an early stage (particularly during commissioning testing) can prevent catastrophic failure and allow preventative maintenance.

F-2.7 Jointing

Once the cables have been installed into a joint bay, a temporary weatherproof structure would be erected over the bay. The joint bay would be cleaned internally and the cables prepared on a concrete joint bay floor. The jointing operation would require dry, clean conditions and good lighting.

Figure 20 – 400kV cable joints near completion of the jointing process



(Courtesy of Prysmian Cables and Systems)

Jointing should only be performed by trained personnel. It is also necessary to ensure that these personnel are trained in safe methods of work, particularly when working close to other transmission lines that may induce dangerous voltages onto the cables being jointed. In most circumstances the jointing team would be employees of the company supplying the cable system or alternatively (and less preferable) jointers from a contractor who have received

training from the cable system supplier to a standard suitable to assemble the joints and maintain the supplier's warranty.

It is usual practice that either three or six power cable joints may be made off in a joint bay. There are six main stages in the jointing process which are as follows:

- preparation of the joint bay and checking of materials, drawings, assembly and safety instructions (to ensure that all components, equipment, drawings and instructions are available before jointing commences)
- preparation of the cables including positioning and straightening
- assembly of the accessory primary insulation
- assembly of the accessory secondary insulation
- assembly of the link equipment and auxiliary cable equipment onto foundations or pits previously installed
- after joint bay backfilling, initial secondary insulation checks by application of DC voltage to ensure that the outer protection is intact

The time required to complete a joint bay containing three joints will depend on a number of factors including the number of joint bays available for jointing (backlog), the number of jointers assigned to the work programme for the project, the joint complexity, the location of the joint bay, access or working restrictions, any induced voltage working requirements and the speed at which each jointer feels competent and safe to assemble each type of accessory. Once a jointing team is available to assemble a joint bay the process should take in the order of three to four weeks. This period includes the assembly of the jointing shelter.

A power supply would be required in the joint bay to operate equipment and lighting, and in the winter to provide heating. Silenced generators would be positioned at joint bays where noise pollution may cause a disturbance. The general objective would be to reduce noise levels to 40–45dB(A) at night, and 50–55dB(A) during the day, at the nearest residence or at the boundary of a premises.

The jointers' transport is normally a covered van. Self-loading vehicles would deliver and collect the jointing structures and fencing. Security patrols will be active with regular night-time visits to any excavated joint bays. In urban environments permanent manned security may be necessary.

Stock-proof fencing and/or bollards would be erected to prevent damage to any equipment which is not buried after installation.

F-2.8 Terminations

Air, SF₆ gas and oil-immersed terminations are all available for XLPE cables. However, for this costing study the least expensive air-insulated cable termination has been considered, as this is the most common type of termination in use. This type of termination would be required within overhead line cable sealing end compounds and for connection to the air-insulated equipment within substations. Figure 21 provides an example of the cable sealing end (of which there will be up to 12 per compound) flanked by examples of surge arrester and an earth switch. The cables approaching this particular termination (manufactured by Südkabel and installed in Dartford) are inside a ventilated air-cooled trough as the cables are in the cable sealing end compound of a force-cooled tunnel.

Cable terminations will be required to interconnect the cable with the overhead line or substation busbar. The overhead line and busbar are insulated by the air.

The cable insulation separates the cable conductor from the earth using a few centimetres of insulation. Air insulation requires several metres of insulation to provide the same performance. The cable terminations must therefore be large enough to raise the live cable conductor above any objects at earth potential to avoid a flashover. In order to ensure the safety of personnel and plant, this electrical clearance distance must also make allowance for such effects as those produced by pollution, rain, ice and snow which will all come to rest on the outer surface of the cable termination during its lifetime. Clearances to other equipment must also be maintained to allow cable insulation withstand testing on completion of the installation.

In general, EHV cable terminations consist of:

- a conductor connector,
- an electrical stress control cone,
- a hollow air insulator containing insulating oil or SF₆ gas, and covered externally with anti-pollution rings, known as sheds,
- an oil level or gas pressure indication, and
- a partial discharge monitoring device.

Figure 21 – 400kV cable outdoor sealing end (ODSE) termination



(Courtesy of Cable Consulting International)

The conductor connector (or stalk) connects between the cable conductor and the overhead line or busbar off-going connector. This stalk carries the electrical current from the cable conductor to the overhead line or busbar.

Unlike a power cable or a joint, the electric field of a cable termination extends beyond the outer surface of the termination. Thus the insulation screen of the power cable is stripped from the underside of the conductor connector down to a point that reduces the electrical stress in the air. The electrical stress is further reduced by the stress control cone which is used to smooth the electric field both in the termination and in the surrounding air.

Figure 22 – 400kV terminations installed near Goring



(Courtesy of Prysmian Cables and Systems)

The method of detecting partial discharge within a termination varies between manufacturers. The favoured method is currently to place sensors within the termination or around the earth bonding leads.

The earthing or bonding connection is attached to the termination close to the connection with the cable screening wires or metal sheath. This connection is electrically separated from the termination support structure such that a cable DC oversheath test may be performed.

F-2.9 Jointing terminations

The cables would be brought out of the ground into a sealing end compound that is fenced and electrified against intrusion for safety and security reasons. The fence also surrounds the first overhead line (OHL) tower, the cable compensation reactors, and a blockhouse to accommodate the electrical protection and control systems relating to the cable. A sealing end compound would be required at each end of a cable section (unless the cable terminates within a substation).

Figure 23 – Weatherproof enclosure for cable termination assembly



(Courtesy of Prysmian Cables and Systems)

The method of installation of the cable terminations depends on the supplier as each supplier uses a different method. The first is to make the termination off in the horizontal position and then to raise it to the vertical position in its completed form. The second method is to assemble the termination in its final vertical position.

The advantage of the first method is that the termination can be assembled at ground level in much smaller weatherproof enclosures. Some manufacturers do not consider this technique suitable for their design of cable termination and have concerns that the internal parts of the termination may move during the lifting process and result in the termination failing in service.

Assembling the termination in the vertical position requires that a large weatherproof scaffolding structure is assembled (Figure 23). This structure is covered with sheeting. These structures must be carefully designed to withstand a high wind load and are secured with guy ropes and anchored with ground weights. The size of the structure will depend on the spacing of the cable terminations for electrical clearance and whether or not the installer uses a crane or an internal beam and hoist arrangement to install the termination insulator over the prepared cable end.

The large scaffolds may take two or three weeks to construct after which the cables are pulled into position up the structure. The jointers then prepare and terminate the cables. Following assembly of the termination the scaffolding structure is dismantled.

Link equipment is then installed (normally secured to the termination support structure) which provides a removable earth connection to the cable termination.

Partial discharge sensing cables, used to carry signals of unwanted electrical discharge from within the accessory, are terminated into a local marshalling box. The distributed temperature sensing (DTS) fibres are also terminated into a local marshalling box. These marshalling boxes are located within either the substation or a building within the cable sealing end compound.

Following installation of the cable, the termination of three cables will take around seven to eight weeks to complete. This time period includes the erection and dismantling of the scaffold.

Figure 24 – Moulsoford Down 400kV SEC near Goring



Courtesy Prysmian Cables and Systems

Figure 24 is an aerial photograph of a 400kV cable sealing end compound at Moulsoford Down near Goring in Oxfordshire. This is the location of a section of underground cabling in a 400kV overhead transmission line between Bramley and Didcott substations. The cable swathe for the new XLPE transmission cables installed in 2010/11 can be seen exiting the right-hand side of the substation (as viewed).

F-2.10 Earthing and bonding equipment

The application of special bonding can reduce cable sheath heat generation considerably. However, a voltage will be induced into the cable sheath and screening wires. The magnitude of this voltage increases with a) the magnitude of the current flowing in each of the circuit phase conductors, b) the spacing between the cable sheath/screen and each conductor, c) the geometric arrangement of the cables within the cable trench (or trenches) and d) the length of cable between specially bonded joints or terminations.

It is a general safety requirement to limit the voltage on cable sheaths under normal continuous operating conditions. In the UK this limit has been 150V for EHV systems but is no longer specified by National Grid, with each project now being separately risk assessed.

The maximum sheath standing voltage will limit the maximum length of a cable section between joint bays/terminations and the number of cable joints installed. This standing voltage may be reduced, and therefore the cable section length increased, by installing the cables in close proximity to each other and obtaining the benefits of increased magnetic field cancellation.

Special bonding arrangements require the use of earth link pillars (above ground) or link boxes (underground) to be positioned at joint bays and terminations. It is a preference of

both the Scottish electricity transmission companies that link pillars are used as these are easier to maintain.

Link pillars (Figure 25) or link boxes will be required at every specially bonded joint bay or termination position. One pillar or box is required for each group of three power cables. At a position where twelve joints are located a total of four pillars will be required. These pillars are connected to the joint metallic shell by means of concentric bonding cables. In order to achieve the highest current rating on the cables the connections within the link pillars cross-connect one cable sheath to the next or earth down all cable sheaths, as is appropriate, as required by the special bonding design.

Where the links in a pillar or box cross-connect cable sheaths, a sheath voltage limiter is installed. This device prevents over-voltages appearing on the cable sheath (or metallic barrier) during abnormal system events.

Figure 25 – Link pillar in arable field



The bonding cables and equipment within these pillars are capable of delivering both electric shocks and burns. The pillars must be capable of withstanding an internal flashover which may occur in the event of an abnormal system event. The pillars must also be protected from farm equipment and large animals by appropriate bollards and/or stock-proof fencing. Each pillar will have a separate earth mat for the bonding system and the link pillar carcass. This mat consists of bare copper tape and earth rods installed below ground.

F-2.11 Installation design

In addition to the section length criteria mentioned above, other factors that need to be taken into account when selecting section lengths include:

- balanced minor sections within a three-cable major section,
- sheath voltage limiter requirements,
- manufacturing weight and height restrictions,
- HV AC testing capability and test set access positions,
- transportation limits, e.g. vehicle width, axle weight and bridge heights,

- access through country villages, lanes and urban areas,
- cable pulling-in force limitations,
- access to cable drum pulling-in and winch positions,
- steep gradients, and
- permissible joint bay locations and maintenance access to link furniture.

The cable trench arrangement is an optimisation process taking into account the cost of cable and the cost of civil works for various trench widths and depths.

Figure 26 – Cable AC test voltage equipment



(Courtesy of Prysmian Cables and Systems)

Where special constructions are required for the cables to pass under or over obstructions, these singular points require consideration within the overall design in order to establish that a route is both practical and economic.

Consideration of the cable installation arrangement must include the practicalities of the civil works and ensure that sufficient space and swathe is allowed to permit economic and safe working practices to prevail along the cable trench and at jointing locations.

F-2.12 Thermomechanical design

A cable with a 2500mm² copper conductor can generate a force of several tonnes when it is heated to its maximum operating temperature.

Various sections of the cable routes have steep gradients. There is some anecdotal evidence that 400kV cables which were installed in England on a steep gradient, have moved under the influence of gravity, despite having been surrounded by cement bound sand when installed.

Where gradients are significant, cable installers must perform a detailed thermomechanical design analysis. Cable snaking and the use of conductor anchor joints may be necessary in order to ensure that movement at the highly stressed cable/accessory interfaces does not occur.

The use of a seamless corrugated aluminium sheath (not as widely manufactured as the lead sheath) can improve thermomechanical performance. Some manufacturers, however, have experienced difficulties in water blocking and ensuring insulation screen/sheath electrical continuity in large conductor cables with aluminium sheaths. The use of a cable design with a corrugated aluminium sheath would have to be explored carefully with manufacturers if it is to be considered.

F-2.13 Charging current and reactive compensation

Both overhead lines and underground cables have the property of adding electrical capacitance in parallel with the normal transmission system circuit. However, due to the proximity of the main conductor in a cable to the earth that surrounds it, this effect is much greater in underground cable than for overhead lines.

The cable capacitance allows cable insulation charging currents to flow, which can cause significant, unwanted changes to the transmission system voltage and loss of useful power transfer capacity. These voltage changes need to be corrected to avoid equipment damage and poor quality of supply to consumers.

The normal way of controlling such voltages is to install “reactive compensation” in the form of shunt reactors. Electrically, these reactors perform in exactly the opposite way to cables (they are electrically inductive rather than capacitive) and consequently, by siting reactors at the ends of a section of cable, the capacitive effect of the cable on the transmission system may be neutralised. These reactors are, however, large and expensive.

Cable charging current is determined by the system voltage and by the dielectric capacitance of the cable insulation. Typical values of capacitance for large conductor size 400kV cables are as follows:

Table 7 – Typical 400kV XLPE AC cable capacitance and charging current

| Cable conductor size | Dielectric capacitance¹² | Reactive power MVar per km |
|-----------------------------|--|---------------------------------------|
| 3000mm ² | 239pF/m | 12.0 |
| 2500mm ² | 225pF/m | 11.3 |

Normal practice with significant sections of underground cable is to place any required reactive compensation at the ends of the cable.

The cost of supplying and installing a 200MVar reactor has been estimated to be £5.786m.¹³ Thus the cost of reactive compensation has been estimated to be £28,900 per MVar.

On a system containing a low percentage of cables, the reactive compensation may not be required for short lengths of cable. However, for the purposes of the this study, where circuit

¹² Values calculated by CCI, using the methods described in IEC 60287

¹³ Reactor costs taken from Beauy Denny APL 5/16 inflated 10%

lengths of up to 75km are considered, a pro-rata cost estimate based on circuit length has been included.

Figure 27 – Cable sealing end compound layout – without shunt reactors

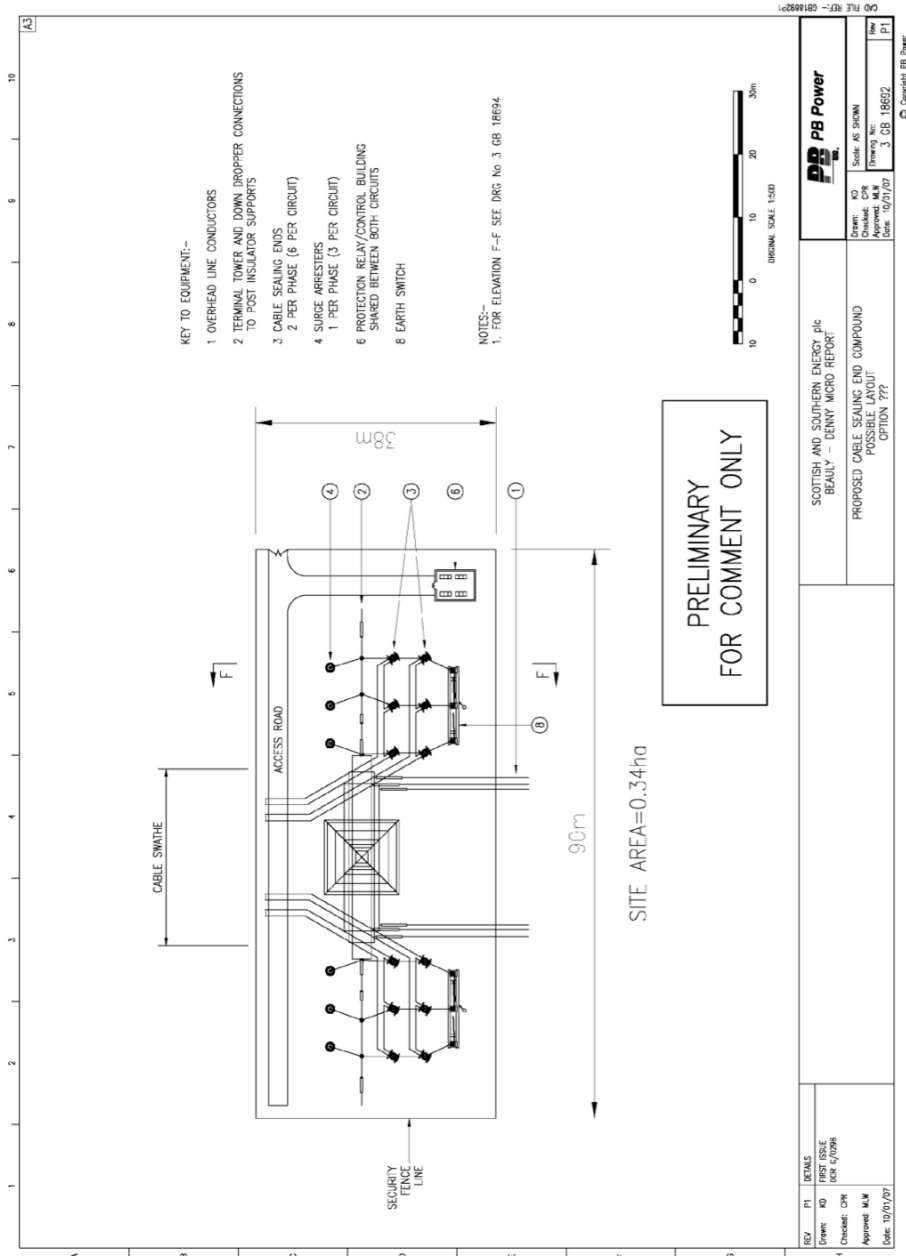

It is anticipated that the reactors would be placed at the terminating substations where possible and, for this reason, Figure 27 shows a drawing of a cable sealing end compound without reactors. The ground area of each would need to be increased by about 0.1 hectares if the reactors were relocated in them.

It should be noted that a terminal tower, cable sealing ends, surge diverters, earthing switches, post insulators for busbar support and relay building would be required at each cable sealing end compound regardless of whether compensating reactors are located in the compound or at the terminating substation.

Underground AC cable will always produce a capacitive load component and this must be compensated for in the network. In the costs that are presented later in this report an allowance has been made to allow for reactance at a compensation level of 100%.

F-2.14 Repair time and weather

Weather may restrict access to the cable in very wet spells or prolonged periods of snow. Repairs to cable require excavations of the cable and the provision of clean and dry conditions for jointing. Either of these may affect cable repair times.

F-2.15 Maintenance and life expectancy of cable

A cable system design life of 40 years is provided by manufacturers with warranty periods of up to 10 years being provided.

Maintenance of power cable systems falls into three categories:

- route patrols and inspections
- planned service maintenance
- emergency fault repairs

Most cable damage is the result of third-party activity. Regular patrolling of the cable route looking for third parties working close to the cable route is a preventative measure. The frequency of such patrols would depend upon a risk analysis of third-party activity likely to take place along the cable route. Routes where cables are buried under roads which are likely to be opened by other service providers are generally at greater risk of damage than cables running through pasture. During a patrol, inspections would be made of all above-ground furniture to check externally that they have not been damaged or vandalised and that security locks are in place.

Planned service maintenance would require the opening of link kiosks or pits. Internal inspections of the pillars would check the condition of the pillar and the equipment contained within. Cable oversheath integrity tests would be performed at link pillar positions as would the tests on the sheath voltage limiters, where these are installed. These tests consist of applying a potentially dangerous DC voltage and thus are only performed by a trained test engineer (normally a contractor) under controlled test conditions and safe working practices.

Some cable manufacturers are offering “maintenance-free” systems. However, this statement refers only to planned service maintenance. It is advisable to check the condition of any equipment which is susceptible to third-party interference. If damage to the cable system does not immediately cause a primary insulation failure (e.g. as the result of a glancing blow to the cable by an excavator) any puncturing of the oversheath or metallic sheath or barrier would allow water ingress, corrosion and progressive XLPE insulation deterioration leading to primary insulation failure. Unlike oil-filled cables, XLPE cables do not contain any pressurised liquid which, when monitored, would indicate a puncture to the cable’s metallic sheath. It would be recommended therefore that unless a system of continuous monitoring is installed for the SVLs and the cable oversheath, regular oversheath integrity tests (preferably annually) be performed.

F-2.16 Cable end-of-life

When EHV XLPE cables become due for decommissioning the following options are available:

- reduce the operating voltage level to extend the cable system's service life,
- remove the cable system entirely and reinstate,
- partially remove the cable system, or
- remove the cable system entirely and install a new system in its place.

Depending on the reason for the decommissioning of a cable circuit the cable system may be capable of operating at a lower voltage level, e.g. 132kV or 11kV. Not every circuit would necessarily be in the correct position to be useful when operating at a lower voltage, and there would be a number of practical difficulties associated with connecting the cable system to a lower voltage network, in particular any transition connections.

Whilst there is a considerable quantity of copper in a cable it is not foreseen that the price of scrap copper will increase sufficiently for it to cover the full cost of excavation and reinstatement of the cable system. The materials in a large conductor EHV cable system are not biodegradable. In order to completely remove direct buried cables from the ground a similar process must be undertaken as that for the installation. This would include a swathe and haul road. It is not foreseen that the cement bound sand (CBS) would be removed from the ground but that all else would. This would include the cable, tiles, warning tape, auxiliary cables, joints and link equipment and above-ground furniture.

If partial removal of the cable system is required then this could be limited to the items above ground that adversely affect visual amenity, such as pillars and associated fencing or bollards. Unlike the previously installed oil-filled cable systems in which the joints contain oils and sometimes contain significant quantities of bituminous compound. XLPE joints do not contain oil, and modern joint secondary insulation protection exists which uses inactive resins in place of bitumen. There is therefore no reason to remove the joints beyond any necessity for removing the cable. If, however, the cables are installed in air-filled ducts, the cable may be withdrawn from the ducts at duct opening positions without the need to excavate the entire length of trench. Under these circumstances removal of the joints would be sensible as the joint bays are likely to be convenient places to expose the duct ends. Withdrawing the cable from the ducts without excavating the cable trench would leave the polymeric ducts in place along with the surrounding CBS, warning tiles and tapes.

F-2.17 Civil works

The method, location and routing of a cable circuit are each determined during a site survey which considers the practicalities of employing a given cable system.

Examples include installation, a) in air on cable supports, b) in surface trough, c) in the ground directly buried with or without thermally stabilised or replacement backfill, d) in ducts, either filled or unfilled, e) in a tunnel with or without forced cooling.

The location of the cable route will be limited by such issues as, a) the total length of cable required, b) the availability and cost of land, c) access limitations, d) ground conditions and ground stability for excavation and cable installation, e) obstructions, e.g. unstable ground,

difficult terrain, tree roots and immovable structures, f) disturbance to the environment and stakeholders, and g) maintenance access.

Access to the entire route must be agreed before works can commence. Ideally this will be performed prior to the commencement of construction works or a risk assessment will have been taken on each area of doubt. The following paragraphs in this construction section detail the main tasks to be undertaken.

F-2.18 Site accommodation and storage

It would be necessary to locate one or more local site storage facilities along the cable route where site offices may be located and materials stored. This storage location would vary from site to site and depend on the availability of local land for hire, availability of utilities, security considerations, environmental suitability and the proximity of the site to main roads.

If the site accommodation is to be located on farmland then the site set-up area should have the topsoil removed and stored separately for final reinstatement. A suitable surface is installed for the placing of site and security offices, welfare facilities, cable drums, aggregates, tiles, timber and vehicles etc. The area should then be made secure with suitable fencing and gates.

Dependent upon the location, generators, fresh and waste water storage tanks, waste material and flammable gas storage will be required to support the operational and welfare facilities. Floodlighting may also be required.

Access to the site may require traffic management to be installed to allow safe entry and egress from the site accommodation.

Figure 28 – Site storage/laydown area and site administration



(Courtesy of Cable Consulting International)

F-2.19 Enabling works and special constructions

For the purposes of this report and the costs estimated, we have considered that enabling works are those works required to bring the land to a position where cable installation works could commence. These costs have not been included in our costings as they could vary enormously from nothing up to major earthworks and retaining walls. Enabling works are

those construction works that should be performed before the main works begin. The works may, for example, be to enable access to the site, demolish structures, remediate polluted land etc.

Special constructions are considered to be those works over and above that required to install the cable Figure 31, Figure 32, Figure 33. These could include constructions such as drillings, cable bridges and ducted route sections. An allowance of 5.6% of the build cost (less owners' launch costs and management costs) has been included in the estimates.

Prior to commencing the main excavations it would be necessary for the contractor to identify any route obstructions and make sure that an economic solution exists to cross or divert each obstruction or to reposition the cable route accordingly.

Figure 29 – Steel cable bridge over a Birmingham canal (special construction)



Details of recorded services would be obtained from utilities, and discussions held with landowners regarding any services on their property. This will include unrecorded services installed by the landowner, such as land drains.

Underground services are located by trial hole excavation with the assistance of location equipment (such as ground-penetrating radar).

Where roads are to be crossed a decision must be made on the method to be used. The installation of polythene or uPVC ducts is commonplace and this may include a concrete encasement. This will require traffic management with the timing of roadworks being agreed with the community council and other interested stakeholders. For busy carriageways the use of trenchless methods such as directional drilling may be necessary to prevent unacceptable traffic disruption.

At railway crossings, where it is not possible for the cables to cross the railway on an existing structure, such as a road bridge, crossings are usually performed using trenchless methods to avoid disruption to railway services.

There are a number of methods available for canal and river crossings. These include bridging (Figure 29), drilling or tunnelling beneath the river bed, dredging a trench in the river bed, and laying the cables direct on the river bed or in ducts. These methods may also be applicable to standing water such as ponds or lakes. The preferred method for crossing rivers is the use of nearby existing structures such as road bridges or, failing this, by directional drilling or boring.

Figure 30 – Retaining walls and earthworks (enabling works)



(Courtesy of Prysmian)

In order to gain access to some areas of the route it may be necessary to install temporary access roads leading from public roads to the working swathe. It may also be necessary to improve the surface of any existing farm tracks. Temporary access roads will be removable and consist of either aggregate installed on a porous membrane or timber/metal matting.

F-2.20 Cable and circuit spacing

The need to keep the cable conductors from becoming too hot requires that they be separated from each other underground.

The terms of reference for the study give three power transmission levels to be considered, for underground AC power cable these are given in Table 8.

Table 8 – AC UGC power transfer requirements

| | “Headline” winter rating | |
|-----------------|--|---|
| column 1 | column 2 | column 3 |
| Capacity | Winter continuous pre-fault rating (single circuit) | Winter 6 hour post-fault rating (single circuit) |
| Lo rating | 1340MVA 1935A | 1595MVA 2300A |
| Med rating | 2680MVA 3870A | 3190MVA 4600A |
| Hi rating | 3210MVA 4630A | 3465MVA 5000A |

The ratings given in column 3 of Table 8 will be familiar as the single circuit ratings of those given in Table 1 of Appendix A in the ToR. For the cables these are 6 hour emergency ratings following a pre-fault continuous rating given in column 2.

Whilst in the terms of reference the ratings for a single circuit are given, in practice, the 400kV lines installed in England and Wales which carry these power levels are double circuit tower installations.

The Lo rating in Table 8 is half of the rating for Case 2.

The Med ratings given in Table 8 are based upon the continuous power rating of two 850mm² all aluminium conductors (AAAC) on an overhead line (OHL). The 850mm² AAAC OHL conductor has a common design name of “Redwood”. This is the largest twin conductor size anticipated to be used on transmission lines operated by National Grid. To meet the equivalent continuous rating using buried underground cables requires two 2500mm² enamel-coated stranded copper conductors per phase. This requires that a single circuit comprises six cables (Figure 31) and a double circuit comprises twelve cables with each group of three cables being buried in the same trench (Figure 32).

Case 3 is based upon the continuous power rating for three 700mm² AAAC OHL conductors with an upper rating of 5000A introduced by the limitation on the switchgear. To meet the rating using buried underground cables would, as one option, require two 3000mm² enamel-coated strand copper conductors per phase. In fact, it would be possible to use a 2500mm² conductor cable in a 2.3m wide trench at standard depth. However, this is not very practicable for long runs where any appreciable extra depth of burial would be required as the cables would be at risk of overheating. A 3000mm² conductor 400kV cable has not been installed and, at the moment, is only offered by one manufacturer as a commercially available product. For the purposes of obtaining likely costs, the use of two conductors per phase of 3000mm² cable has been employed due to the reduced installation costs of two rather than the alternative of three cables per phase. It should also be noted that three cables per phase of 400kV cable has not, to date, needed to be installed in the UK.

Figure 31 – Double circuit one cable per phase – swathe cross-section

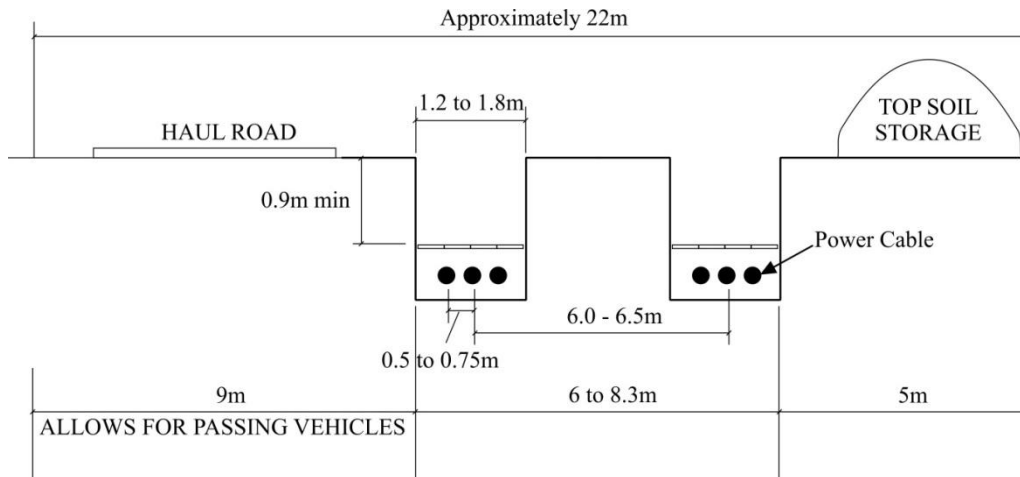
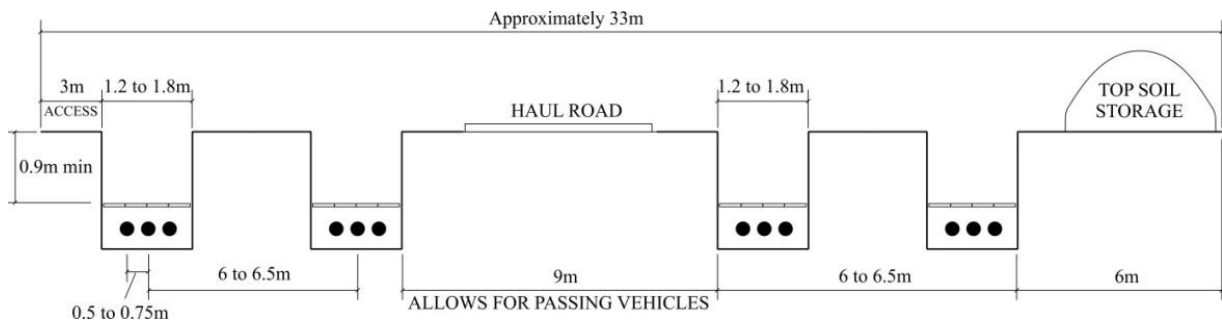

Figure 32 – Double circuit two cables per phase – swathe cross-section



Underground Cables

The space requirements for the groups of conductors, plus the haul road and space for the temporary storage of spoil from the trenches, amounts to a working swathe some 22m wide for two groups (Figure 31) and some 33m wide for four groups (Figure 32). If there is a necessity to introduce interceptor drains either side of the swathe to limit water running across or off the swathe then the swathe may need to be increased. National Grid has advised that on the 400kV Newby–Nunthorpe connection (which contained 12 power cables) a swathe of 40m was used and that the contractor found that even this width was limiting. If necessary, this swathe could also be reduced by the use of lower thermal resistivity backfill materials. This backfill would be a special construction as defined under this report and introduce additional costs. The trench widths and layouts given in Figure 31, Figure 32 and Figure 33 will meet the current rating requirements.

Figure 32 illustrates a swathe arrangement. The cable trench containing three cables will be between 1.2m and 1.8m wide. A 3m access way is allowed between the outer trench and the fence to permit access from both sides of the trench during such activities as cable pulling and the installation of any drainage. Thermal separation between groups of cables for the same circuit will be between 3.7m and 5.0m. The trench width and circuit separations are approximate as these will be dependent upon the cable build available from the manufacturer and whether air-filled ducts are employed.

A central reserve of 9m is allowed to install a haul road with passing places. This road will allow construction traffic to move up and down the swathe collecting and delivering materials with minimal disruption to local roads. This separation also provides thermal independence between the circuits.

A storage area has been allowed to retain topsoil for the duration of the works.

This type of cable layout has been developed from a number of years' experience and is consistent with recent practice in the UK – for example, the “Second Yorkshire Line” and the Ross-on-Wye installations where, in each case, a proportion of the overhead line route has been placed underground.

Figure 33 – One circuit, two cables per phase – road cross section

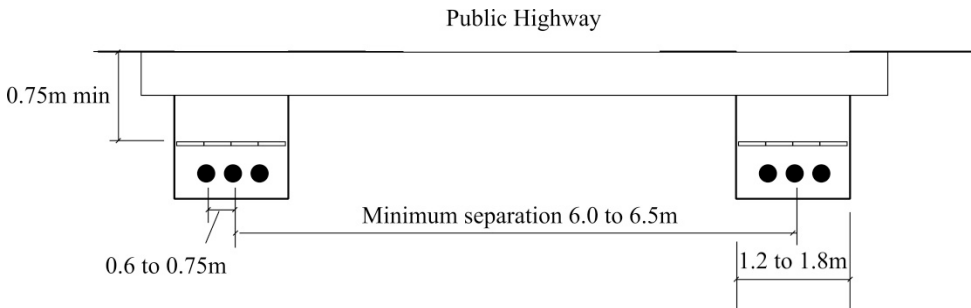

The installation of two cable circuits with two cables per phase through a densely populated area would be unusual. If it is required to transmit these amounts of power across an urban area then it is usual to use overhead line routes which go around, rather than through, urban areas. Cable circuits crossing urban areas are generally delivering power to the inhabitants rather than passing through. Cable circuits in cities therefore tend to radiate away from peripheral substations being fed by overhead lines and, for this purpose, the energy is dispersed by transmission class cables either as a single or double circuit using only one cable per phase.

It would also be unusual for there to be sufficient space to install a double circuit at two cable per phase through an urban area under the same public road; the author is not aware of any such installations. Most roads are not sufficiently wide to accept all 12 power cables but if necessary one solution could be to route the cable trenches along alternative routes through the urban area.

Figure 33 shows a possible installation arrangement for six cables under public roads. When high-power transmission circuits are installed under public roads, the road may be used as the means of site access. However, the surface of the road must be broken and removed and reinstated after installation. Traffic management, a space restriction and the need to reinstate the road surface increase the cost of installation in urban areas.

Prior to undertaking a cable route in an urban area it is necessary to confirm that there is space to accommodate both the cables and the joint bays in the roads. This should involve the use of service maps and site investigations by both ground-probing radar and exploratory excavations. The late discovery, for example, of a large sewer obstructing a cable route can increase costs with both the requirement for an additional special construction and the delays in procuring its design, if one can be developed.

The case studies in this report consider routing cables through Avonmouth, whilst this area is reasonably densely populated it cannot be equated with the centre of a large city such as London. When subterranean services become sufficiently dense, tunnelling and the future asset the tunnel represents for additional services becomes attractive. This tunnelling, however, is not of a cut and cover type (normally square in section) but the circular deep tunnel.

F-2.21 Rural swathe preparation

Prior to any excavation the area within the swathe must be worked during the right time of year. This will depend on the ground condition. Generally the best time for working on the land is between April and October when rain and snowfall are less prominent. There are also likely to be issues regarding disturbance of birds or other fauna or flora that may need to be addressed.

Figure 34 – Clearing woodland from the swathe (Ross-on-Wye 400kV)



(Courtesy of Cable Consulting International)

Figure 34 shows woodland being cleared from the swathe to allow access for the cables and expansion of the existing Walford cable sealing end compound near Ross-on-Wye. This photograph was taken in October 2011. The topsoil storage can be seen on the left-hand side; the photographer is standing on the 450mm thick road-stone haul road (note the geosynthetic lining under the haul road). The swathe boundary fence can be seen on the right at the edge of the cleared swathe.

Figure 35 – 400kV cable swathe at the Goring Gap



(Courtesy of Prysmian Cables and Systems)

Figure 35 is a photograph of the cable installation swathe taken in 2010 with a joint bay temporary shelter in the middle distance on the left of the swathe. This photograph was taken after all cables were installed and awaited completion of jointing works prior to topsoil reinstatement. It can be clearly seen that in this case the cable route does not follow a straight line as is normally the case with an overhead line.

If required, following a land drainage study, a drainage system would be installed to collect water running across or off the swathe. The water would be allowed to settle in soakaway areas or, where necessary, this drainage system would include settlement ponds to avoid discharged silt entering water courses.

Within the swathe the topsoil would be stripped and stored to one side. A temporary haul road would then be installed along the route between access points onto local roads. These access points would need to be agreed with the community council and interested parties. In principle the haul road would carry as much as possible of the construction traffic. However, some vehicle journeys on local roads would be inevitable to reach the site access points and make use of such facilities as road bridges where rivers or railways cut across the route. Wheel-washing facilities would need to be maintained at all haul road egress points. Road signage would have to be provided to direct construction traffic towards and away from site access points over predetermined routes.

The working swathe would be protected by fencing with limited and controlled access to, and egress from, the site.

F-2.22 Excavation of and backfilling of direct buried trenches

Along the cable route the trenches would have to be excavated to accommodate the power cables. Additional excavations would be required at the joint bay positions to accommodate the power cable joints. If the ground is waterlogged, dewatering may also be necessary.

Figure 36 – A section of trench box shoring (out of the trench)



(Courtesy of Cable Consulting International Ltd.)

In Great Britain the requirement for cable protection is covered under Section 14 of the *The Electricity Safety, Quality and Continuity Regulations 2009*.¹⁴ The regulations do not specify the depth at which cables should be buried but require that the cables should be sufficiently protected and their position marked as a warning during excavations. This has been interpreted by National Grid, for England and Wales, to specify¹⁵ that transmission class cables be buried beneath warning tapes and protective cover tiles, the latter of which will have been installed to a depth of 0.6m under footpaths or grass verges, 0.75m under roads and 0.9m under good agricultural land. There are some exceptions where transmission class cables are currently installed in a surface trough alongside canal towpaths and within substations, in which case additional mechanical protection is provided.

In order to reduce the amount of material removed, the trench farthest from the haul road, would be excavated first. Mechanical excavation would be performed, and the material to be removed from site would be placed into tipper trucks. A significant portion of this initially excavated material would be removed from site. The actual quantity of material removed would depend on the dimensions of the trench for each particular cable section, the depth of the topsoil and the quantity of imported thermally stable material required – usually cement bound sand (CBS). A portion of the excavated material may be retained and stored within the swathe and kept separate from the topsoil. Under some circumstances the subsoil remaining may be spread across the swathe providing the landowner and planners are in agreement.

In order to keep the cable trench clean and safe it is usual practice to shore the trench. Shoring may be provided in a number of ways. For example, traditional double-sided close-timbered shoring, hydraulic shoring or box shoring.

Figure 37 – A close-timbered cable trench



(Courtesy of Prysmian Cables and Systems)

¹⁴ The Electricity Safety, Quality and Continuity Regulations 2009, available at <http://tinyurl.com/7j9w7ax>

¹⁵ Installation Requirements for Power and Auxiliary Cables, National Grid Internal Technical Specification, TS 3.05.07 issue 6 April 2011

Excavation of the trenches would include joint-bay excavation. A joint bay for three joints will be in the order of 10m long and 3m wide and approximately 2m deep. The base of the joint bay must be level and a concrete pad installed (some 150mm thick with light reinforcement) as a working surface. The sides of the excavation are shored to prevent collapse.

On completion of the excavation the cable trench bottom is cleared of sharp or large objects and any free water is pumped from the excavation.

Following the installation of the cables, ducting, CBS and cover tiles in the outer trenches, the excavated material which was not removed from site would be used to infill the trenches and would be compacted. The inner two trenches nearest the haul road would then be excavated and the excavated material used to top up the backfill of the outer trenches. The remainder of the excavated material would be stored on site, separate from the topsoil and used to complete the backfill of the inner trenches and joint bays following cable system installation. Once backfill is completed, the surplus material would need to be removed from site as waste/landfill.

F-2.23 Excavation of and backfilling of ducted trenches

Where cables are installed in ducts, these would be installed in a continuous operation with excavation at the front, followed by ducts, CBS, tile and warning tape installation with backfilling following on.

For a fully ducted cable system the ducts would be installed from joint bay to joint bay.

F-2.24 Cable installation for direct buried installation

Once the bottom of the cable trench has been cleared of sharp and large objects, a cable bedding of CBS 100mm thick is laid. The CBS is tamped into place to form a firm surface upon which cable installation may take place. This thickness may be increased to accommodate a fibre optic communication duct, or alternatively the fibre optic duct may be installed above the cover tile where plough damage is not anticipated.

As the trench is being prepared, the drums containing the power cables would arrive at one of the joint bay positions. The area around the joint bay would have been prepared to accept the drums onto a hard standing. The drums are delivered to site by low-loader or cable trailer. A typical low-load trailer is 18m long, 2.5m wide and has a ground clearance of 560mm. It has an unladen weight of 28 tonnes and this gives a loaded weight of around 59 tonnes for a 500m cable length.

Figure 38 – Cable drum carrying trailer



Transporting the drum over motorways and major roads should not present any problems and the low-loader width is such that a police escort should not be necessary.

If cable lengths longer than about 500m are used (manufacturers have been increasing factory capabilities to make length in the order of 800m to 1.1km), drum widths would have to increase, and under such circumstances the drums may be loaded transversely onto the vehicle with the drum spindle aligned along the length of the vehicle trailer. This transverse mounting of cable drums onto low-load trailers allows much wider drums to be transported. However, they would still be limited by height restrictions; for example 16' 3" (4.95m) bridge clearance on motorways.

Specialist hauliers would also be required to transport large drums. Such hauliers can provide low-load trailers with rear-wheel steering and tandem tractor units for steep inclines. Figure 39 shows a low-bed trailer height of around 450mm. The trailer is also fitted with rear wheel steering.

Different manufacturers use different drum sizes to suit their cable manufacturing facility and it is important that drum weights and dimensions are fully investigated at the contract tender stage.

Transporting the drum through country villages and along country lanes may present problems and the temporary removal of street furniture, overhanging tree pruning, bridge strengthening, possible road closures and other road safety and access measures may be necessary.

Figure 39 – Cable drum loaded transversely onto a trailer



Full cable drum loaded on to a rear-wheel-steered low-load trailer

In order to limit the overland portion of the route it is suggested that cable drums arrive at suitable ports in the UK capable of handling large drums.

Closer to each construction site the roads may become steep and narrow with sharp bends. Under such circumstances a detailed transportation and access survey would need to be undertaken.

Upon arrival in the UK (there are no UK factories manufacturing these cables), the cable drum would either be unloaded at a temporary storage site or taken directly to the cable pulling-in position. For reasons of security and programme flexibility it is usual that one or more temporary materials storage sites for are prepared.

Figure 40 – Offloading cable drums



(Courtesy of Prysmian Cable and Systems)

A cable pulling system is then installed into the trench. Traditionally this is a steel bond and winching system with free-spinning cable rollers placed along the bottom of the trench. Other

methods include the use of motorised rollers or tracked caterpillar drives. Winching equipment is normally diesel powered. Generators, however, would be required to power electrically operated cable pulling systems. Communication during the cable pulling operation is by radio handset to supervisors strategically positioned along the cable route. The winch or power roller system operators are also included in this communication system.

Figure 41 – Cable installation in an open cut trench



(Courtesy of Prysmian Cables and Systems)

The cable drum is threaded with a spindle and raised from the ground using hydraulic jacks mounted on lifting frames (jack stands). The cable is then pulled from the drum into the cable trench onto rollers. Enough cable is pulled from the drum until sufficient is available in the far joint bay for jointing onto the next cable length. The cable is then lifted off the rollers onto the trench floor. This process is repeated for all cables, following which the rollers and pulling equipment are removed from the trench. The cable is then positioned in the trench at the correct spacing.

Figure 42 – EHV cable trench in a public road (north-west England)



(Courtesy of Cable Consulting International)

In some circumstances an earth continuity cable must be laid with each group of three power cables. This would be installed with a mid-point transposition of the section length from one side of the centre cable to the other.

Distributed temperature sensing (DTS) fibres or DTS ducts for fibres would be placed on the cables and/or in the backfill at this stage. These fibres are used as part of a temperature monitoring system to calculate the cable conductor temperature along the cable route to estimate the load capacity of the cables and detect any locations where soil or cable surface temperatures are abnormally high.

Cement bound sand (CBS), delivered by mixer (Figure 43) would then be tamped into position around and over the cables to a depth of approximately 100–150mm above each cable. Cover tiles containing a warning are then installed above the cables, these are fabricated from either reinforced concrete or reclaimed polymeric materials.

Figure 43 – Delivery of cement bound sand to the cable trench



(Courtesy of Prysmian Cable and Systems)

At this point the timber shuttering is removed and the trench is then further backfilled with previously excavated material. The backfill is compacted and includes warning tapes installed 150mm above the cover tiles.

The duration of the excavation, cable installation and backfilling works for the 12 cables in a cable section will depend on the nature of the ground, e.g. rock content, dewatering content etc. In general, it would be expected that the 12 cables would be installed and backfilled over a 600m long section in around 16 weeks.

For a large project in the order of 75km it would be necessary to split the project into areas and to have a number of construction teams at work simultaneously. To date, no EHV AC directly buried project has been constructed at this length. The nearest to this length is the 500kV project in Japan which was around 40km in length and included tunnel construction. National Grid, however, is able to handle large projects as evidenced by the construction of the Elstree to St John's Wood tunnel, Croydon tunnel and the ongoing London tunnels project where an eight-year cable tunnel construction project is underway due for energisation in 2018. Whilst a 75km buried cable construction project has the potential to cause significant local disruption it is considered that National Grid should be able to mobilise, given adequate time, to meet this challenge.

F-2.25 Cable installation ducted sections

Unless the ground conditions are poor, it is not usual for the trench to require shoring with timber when the ducts are installed. The duct system must be installed with care to avoid sharp discontinuities at duct joints, duct or joint breakage, duct wall crushing or the ingress of foreign objects into the duct.

Cable installation into a ducted system relies on a low coefficient of friction between the cable duct and the cable. This is achieved by installing the ducts with very gradual bends using as few discontinuities as possible, good duct cleaning and the use of biodegradable water-based lubricants during cable pulling.

Cable pulling calculations are required to determine the expected maximum cable pulling force required and the forces expected between the cable and the duct wall. The handling of the power cable drum ready for pulling is the same as that described previously for a direct buried installation. The cable is winched into place by pulling on the leading end of the cable (known as nose pulling).

The DTS fibres are attached to the outside of the duct or installed within a separate duct attached to the outside of the power cable duct.

F-2.26 Swathe reinstatement

Following installation of all cable and joints in a section, the swathe would be cleared. This will include the removal of any remaining security fencing, uplifting and removal of the haul road and temporary hard standing areas, and reinstatement of surfaces and topsoils.

Figure 44 – Topsoil replacement



(Courtesy of Prysmian Cables and Systems)

Where necessary, this reinstatement may include replanting of hedges, replacement of fences, removal of temporary land drains and settlement ponds, reinstatement of permanent land drains and the like.

If trees are removed, these would only be replaced if their roots did not interfere with the power cable installation. The allowable distance of any tree from a cable would depend on the type of tree and its expected future growth.

Where beneficial, and prior to topsoil replacement, the ground would be subject to subsoil ripping to break up the compaction due to construction activities.

F-3 Application of the technology

Underground power transmission cables differ from overhead line (OHL) and gas insulated line (GIL) in that they are flexible, may be manufactured in continuous lengths (if necessary these lengths can exceed several kilometres, although lengths of less than one kilometre are used for most practical installations) without the requirement for a site-fabricated conductor joint.

Three HVAC cables may be installed in a single trench having a width of around 1m. The cable trench can easily accommodate a turn in any direction whose radius is 5m or more (cable can be bent to a smaller radius, but a 5m radius is a practical minimum to ease installation in a cable trench).

Power cables may thus be physically accommodated within a narrow trench and are ideal for installation in built-up areas where the subterranean service density (number of other cables, pipes, sewers and ducts etc. along a route) is not too high. This confinement of power cables to a narrow trench enables cables, particularly a single circuit of three cables, to be installed in locations where wide trenches (which might accommodate GIL), or a wide aerial clearance to allow the air to electrically insulate the conductors of an overhead line is not available. The limit on the trench size and of the proximity of one group of three AC cables to the next is largely determined by the thermal constraints of heat dissipation. The majority of cables are installed in urban and peri-urban environments.

Underground cables may be used to pass beneath obstructions. The technology of horizontal directional drilling is capable of installing a polythene pipe beneath an obstruction through which transmission cables may be installed. These obstructions may exist within cities, and include arterial roads, railways and rivers. The maximum length of the installed cable pipe is dependent upon the ground conditions for drilling and the capability of the drilling machines. One installation of HVAC cables inside a cable pipe is described in a CIGRÉ paper.¹⁶ This cable project crosses beneath the entrance to Rotterdam harbour and includes a form of integral water cooling within the pipes. The crossing includes drilling lengths of 500m. However, if ground conditions do not suit drilling and the required length of installation is not too long (around 100m) then alternative methods, such as pipe jacking (where a metal pipe is thrust – jacked – from the rear with a cutting head at the leading end) may be considered.

Underground cables may also be installed to allow other developments. These installations may be privately financed. The finished value of a development may be increased due to an improvement in the visual amenity as a result of installing an underground transmission system or the development may not be possible without the removal of an overhead transmission system. For example, the replacement of overhead lines with buried cables at the end of, or alongside, airport runways. Two EHV projects where this has been performed in the last 10 years are underground cable replacements for overhead line at Manchester Airport and Madrid's Barajas Airport.¹⁷ In the case of Manchester Airport the overhead lines were placed underground (direct buried) in order to allow flights to occur from a new second

¹⁶ "Development of a New 380kV Double Circuit XLPE Insulated Cable System in the Netherlands", Koreman C. G. A. et al., B1-107, CIGRÉ, Paris, 2006

¹⁷ "Red Electrica Installs Spain's First 400kV Cable System", Granadino R., Red Eléctrica de España, Transmission and Distribution World, Aug 1, 2005, <http://tinyurl.com/7tmc7cj>

runway, and in Spain the cables were installed in a cut-and-cover shallow tunnel only 2 metres deep. At Madrid the overhead line conductors presented a hazard to aircraft take-off and landing routes and there were concerns that the OHL transmission lines would interfere with the aircraft's automatic navigation systems.

Underground cables may also be installed for reasons of environmental benefit. During the construction phase, the installation of buried cables takes longer than an overhead line and the groundworks are more extensive with vegetation destruction across the cable swathe. However, in the long term, the lower visual impact of cables compared to overhead line may outweigh other adverse environmental impacts (for example, the impact to buried archaeological remains and the local hydrology). Following public inquiries in 1992 and 1995 considering the installation of a transmission overhead line route through the Vale of York, underground cables were subsequently installed in areas where consent for an overhead line was not granted.

A requirement to place transmission lines underground may be made by Acts of Parliament or government bodies. The most recent UK example of this is the undergrounding of overhead lines for a development across the Olympic Park at Stratford in east London, this being a request of London Development Agency in 2004. The Olympic Development Agency (ODA) was established in April 2006, and in November 2006 the operational contracts relating to the project were novated to the ODA.¹⁸ Olympic funding supported the cost of the project albeit that the additional maintenance required for the cables in a tunnel is believed to fall to electricity consumers as an allowable operational cost under Ofgem allowances. The installation of cable tunnels under the Olympic Park to replace the pre-existing overhead lines was the second milestone of Phase 2 of the ODA plan.¹⁹ The 400kV cable tunnel project²⁰ was performed over 6.5km, with three shafts, to an average depth of 25m and consists of two circuits of 2500mm² XLPE cable. The project was completed in 2009. A total of £250m was spent for two tunnels, one for National Grid cables and the other for EDF cables operating at 132kV.

The types of tunnels to install underground cables and their methods of cooling vary considerably. These tunnels may be shallow tunnels, so called cut and cover tunnels, made of precast rectangular cross sections and laid into an open cut trench as used at Madrid Airport.¹⁷

In EHV cable tunnels the heat generated by the cables, operating at full load, is considerable; around 180W/m per circuit (three cables). This heat loss is the equivalent energy required to boil around 45 litres of water per day from every circuit metre of cable. This heat generated by the cables must be extracted from the tunnel if rapid overheating of the cable and the tunnel is to be avoided, particularly at high loading.

Short naturally ventilated tunnels were also installed in the 1970s and 1980s. These tunnels relied upon a chimney effect to draw air through the tunnel. These were efficient installations with the capability of self-cooling for a limited cable heat generation. These naturally cooled tunnels were installed under large arterial roads before the availability of modern directional drilling techniques using non-ferrous pipes.

Tunnels in London were originally cooled by installing separate pipe-water cooling within the tunnel, such as the circuits out of Wimbledon substation, or integral water pipe cooling, such as the circuits installed in the cable tunnel installed under the River Severn connecting

¹⁸ "Statement of Accounts", London Development Agency, 2008, <http://tinyurl.com/74u5hto>

¹⁹ "Programme baseline Report Summary", Olympic Delivery Authority, September 2009

²⁰ "Case Study 2 – new cable tunnel", National Grid, <http://tinyurl.com/74u5hto>

England to South Wales, or the now obsolete trough and weir water cooling system where cables were laid in an open surface water trough with the water flowing down hill to a return pump and pipe through heat exchangers.

Figure 45 is a photograph inside the Wimbledon to New Cross cable tunnel. The cables are installed within the concrete trough on the left, along with separate water cooling pipes. The trough is filled with a weak mix of cement bound sand. Communication and lighting cables are suspended from the ceiling in this tunnel.

Figure 45 – Wimbledon–New Cross cable tunnel



(Courtesy of Cable Consulting International)

Water pipe cooling is still installed overseas both in Austria²¹ (directly buried cable with joints inside chambers) and in Japan (tunnelled). Water cooling systems are not favoured by National Grid due the cost of maintenance and the low availability of the cooling system.

The favoured recent method of cooling for new tunnels and shafts installed in the UK is by the use of air fans (Figure 46). These fans are used to pull air through the tunnel, evacuating it to the atmosphere, thus avoiding heat energy from air compression by the fan entering the tunnel; in other words the air in the tunnel is normally sucked rather than blown.

Tunnels have been used in the London area where service density is high and it is difficult to install, protect and maintain cables installed beneath the busy roads. Once a tunnel is installed the expected life of the main structure (100 years or more) may be expected to exceed the lifespan of the cables (40 years).

Electrical power delivery to a big city such as London or Tokyo may be expected to continue, and it is likely that the cables will be reinforced or replaced in the future. The installation of a tunnel with its options for future circuit replacement or reinforcement make tunnels attractive option for city supplies. At lower voltages in London (132kV) there are a number of tunnels and subterranean installations overcoming space restrictions.

²¹ "400kV Vienna, The Vienna 400kV North Input" Vavra J. et al., B1-101, CIGRÉ, Paris, 2006

Figure 46 – Air cooling fans during installation



Underground
Cables

Vertical shafts and tunnels are also useful at hydroelectric stations, such as at Cruachan power station in Scotland where a subterranean substation is installed with high voltage transformers located close to the turbines.

Underground power cables are not so useful for installation in unstable ground conditions. Cables installed in the ground are mechanically restrained by the surrounding backfill; when held secure, power cables and their accessories may be expected to perform serviceably. However, if the surrounding backfill moves or slips, the cable can be placed into excessive tension or compression. In extreme cases sheer across the cable can occur, deforming the cable. Poor installation ground includes ground liable to land slip, such as shallow soil on a rock incline where heavy rains can cause the soil-to-rock interface to become unstable. The installation of cables across wet unstable ground such as peat bog can be problematic due to the problems of settlement and the non-uniform forces acting on the cable and the joints. Under such conditions overhead line tower foundations and piling offer a more secure solution.

The installation of cables in mountainous terrain is also problematic. During a study²² into cable installation in Perth and Kinross in Scotland during the Beaulieu-Denny transmission line public inquiry, a cable route passing between Tummel Bridge to Appin of Dull was considered and the mountainous terrain was so adverse to direct buried cable installation that the only feasible solution appeared to be the installation of a cable tunnel. The V-shaped valley route is currently traversed by a multiplicity of overhead line towers.

Mountainous terrain can be poorly serviced by trunk roads with bridges capable of providing access for the cable transport to deliver the large and heavy cable drum carrying vehicles (up

²² “APL/PTH-41, Proposed Beaulieu to Denny 400kV Overhead Transmission Line, The use of underground cable as an alternative to overhead line: Perth & Kinross, Final report”, PB, September 2007

to 59t GVW). Even if it is possible to deliver cable to the site, it may not be possible to excavate side-slope gradients without terracin, which may be visually unacceptable. This report has not considered the cost of large-scale rock cutting or blasting to excavate trenches in rock. Any requirement to deliver a reactor may also be problematic, as this abnormal load may require a 120t road load-carrying capability. Bridge modifications or strengthening may also be required, which may adversely alter the nature of a bridge. For example, in Scotland there were particular concerns at modifications to small stone bridges and the military roads that had been constructed by General Wade, some of which are seen as being part of the cultural heritage of Scotland.

In mountainous terrain overhead lines are the preferred technology. With an overhead line it is possible to deliver tower materials in small sections by helicopter to some of the most inaccessible locations, and the conductors, suspended between the towers, are pulled into position and can relatively easily span rocky outcrops, vertical rock faces, deep ravines, small lakes, rivers and bogs with much less time, trouble and effort than a direct buried underground cable, which would have to be laid, buried, bridged and secured, and at times the accommodation for cables blasted into the terrain.

F-3.1 Operation

In common with the OHL, trees would need to be cleared from the route during the operational life of the underground cable (UGC), and as with the OHL, once the installation had been completed, the ground, apart from small sections of the route accommodating joint bays, could be returned to low-growing vegetation or agricultural land. The building of permanent structures is not normally permitted over directly buried cables for reasons of maintenance, access and safety.

Unlike an OHL, however, a low level of “transformer-type” hum would emanate continuously from the sealing end compounds (if reactors are installed there), whilst along the route the cable would be silent.

F-3.2 Faults and reliability

Electrical transmission systems need to have an inbuilt robustness which must be capable of withstanding faults without loss of supply. This robustness is often referred to as the level of “redundancy”, an “n-1 level” meaning that if one circuit faults, the systems is still capable of operating, and “n-d” meaning that if a double circuit is lost (most transmission overhead lines have two circuits on them) and if an OHL tower suspending a double circuit overhead line fails then both circuits would be lost.

To date the installation of 400kV XLPE circuits in the UK has only met with one early fault: at the Rocksavage power station on Deeside in the 1990s. All other circuits in the UK have performed successfully and are now being used to replace some ageing and some problematic oil-filled (also known as fluid-filled) cable installations.

In 2001, a serious cable fire on 11kV, 33kV and 110kV cables caused a blackout in Stockholm, referred to as the “Kista Blackout”,²³ which caused power loss to 50,000 people and 700 businesses employing upwards of 30,000 people.

²³ “The 2001 Kista Blackout: Corporate Crisis and Urban Contingency”, E. Deverell, Publishers Elanders Gotab, Stockholm 2003, ISBN 91-89683-06-4, <http://tinyurl.com/73wltz6>

A serious cable tunnel fire on 6 April 2006 was reported²⁴ in northern China. The single square-section tunnel contained six 220kV and three 66kV cable circuits, all of which were damaged by fire following a cable fault. The operators had in use an automatic reclose system which tried to re-energise the faulted cable.

The Stockholm and China incidents indicate the risks of placing assets in the same tunnel that could be subject to a common mode failure, in this case a fire. The use of XLPE insulated cable rather than oil-filled cable has reduced the risk of this type of incident. However, the base material for XLPE insulation is polythene which has a similar calorific content to petroleum and, once alight, burns and propagates readily.

The use of fire-resistant coatings on cables in tunnels is of assistance but does not entirely eliminate the fire and smoke risk in a tunnel. Such coatings generally have a limited fire resistance capability. Should a cable fire become sufficiently established the coating materials may themselves burn.

One of the early landmark 380kV XLPE installations in Berlin, Germany, suffered a serious fault in December 2009 on line number 921, Friedrichshain–Marzahn. The fault occurred on the cable termination into SF6 switchgear. This failure was publically announced at a presentation²⁵ in Brussels in 2010. The failure occurred in a cable termination and was independently assessed to be the result of a latent defect as installed by the manufacturer almost 10 years earlier. The resulting damage to the cable and the gas-immersed switchgear was reported to cost up to €5m with an estimated time of non-availability of between 10 and 12 months. This is an example of a latent defect of installation which was not discovered by testing prior to commissioning. The defect was small but the effect over time sufficiently cumulative to result in a significant and costly failure.

In recent years a significant quantity of HV and EHV cable has been installed in the Gulf region of the Middle East. The authors received a response from the transmission operators Transco in Abu Dhabi where, at the time of the information being provided, they had installed 55 circuit kilometres and had a further 164km in the construction phase. The cable-materials-only price per km accepted by Transco was of a similar value to that provided by suppliers for this report (in the order of £2.1 to £3.0 per circuit km). Transco have purchased 400kV cable from both European and Asian manufacturers.

The first 400kV Transco circuit was energised in April 2006 and the latest (prior to this reports publication) most recently at the end of 2011. So far, Transco have had ten joint failures: six occurred while the circuits were in service and the remaining during testing of the cable system. With regard to fault response times, the utility in Abu Dhabi reports that return-to-service times are about two months.

There is conflicting opinion expressed between the operators and the cable manufacturers regarding the comparative reliability of OHL and UGC. In a Europacable document supplied to the vice-president of the European Commission on 19 June 2002, the view was expressed that cables have always had a good reliability record with cable faults of 0.072 failures per 100 circuit km per year, and OHL showing around 0.17 “permanent failures” per 100 circuit km per year. This statistic does not, however, take any account of repair times or circuit availability.

²⁴ “Fire Accidents of the Power Cable Line in Tunnel, and Preventive Methods” Junhua L, et al., IEEE Electrical Insulation Conference, Montreal, QC, Canada 2009

²⁵ “Operational Experience of High Voltage Power Cable Systems in Berlin and Future Planning for Bulkpower Lines”, Presentation, Euroforum Conference, W. Fischer, 50Hertz, Nov 2010, Brussels

The European Transmission System Operators organisation (now ENTSOe) published, on 31 January 2003, their “ETSO Position on use of Underground Cables to develop European 400kV networks”. They stated:

Even though the fault rate is expected to be lower than for overhead lines, this is not necessarily true for EHV networks because of the UGC techniques for fault finding and repairs (terminations, joints).

While taking into account all of the constituent elements of the connections as well as incidents due to external causes, the experience of some ETSO members shows that the rate can be higher for a UGC (mainly due to external causes and accessories) than for an OHL.

As far as repair time is concerned, it seems that the repair duration differences are still in favour of OHL and become increasingly so as the voltage rises. For a UGC, it takes more time to locate and repair a fault, on average 25 times longer than it does for an OHL. The experience shows that the repair duration of cable damage requires between two weeks and 2 months depending on the technology and location of the fault.

Unavailability data recorded by National Grid (and reported in the Babbie report ²⁴) of 0.126 hr/km/year for OHL and 6.4hr/circuit km/year for UGC (for the National Grid network) seems to support this ETSO position, and it is concluded that this is likely to be more representative of the present reality for EHV cables than the Europacable opinion.

Obtaining information on fault data from both users and suppliers of cable systems is difficult. It is considered that the transition system operators do not wish to publicise product failures in their systems and suppliers do not wish to highlight product or installation failures with which they have been involved. In order to protect their business interests, confidentiality agreements are often required to be signed by one or more of the parties before information is provided to third parties, particularly those involved in investigating the cause of a fault.

Failure statistics for power cables were published by a CIGRÉ working group²⁵ and a subsequent paper²⁶ (published at JICABLE in 2011) updated the CIGRÉ failure rates for cable components and circuits at 380kV (the European equivalent of 400kV). The tabulated failure rate findings of this latter paper are given in Table 9.

Table 9 – Failure rates of cables and accessories

| | Minimum failure rate | Maximum failure rate | CIGRÉ failure rate |
|-------------|--|--|--|
| | Per [100 accessory years] or [100 circuit km years] | Per [100 accessory years] or [100 circuit km years] | Per [100 accessory years] or [100 circuit km years] |
| Cable | 0.079 | 0.120 | 0.133 |
| Joint | 0.016 | 0.035 | 0.026 |
| Termination | 0.092 | 0.168 | 0.032 |

²⁴ “The Highland Council, Cairngorms National Park Authority and Scottish Natural Heritage: Undergrounding of EHV Transmission Lines”, Jacobs Babbie

²⁵ “Update of service experience of HV underground and submarine cable systems”, Publication TB 379, Working group B1.10, CIGRÉ, Paris, 2009

²⁶ “Return of Experience of 380kV XLPE Landcable Failures”, Meijer, S et al., paper A.3.7, JICABLE, Paris, 2011

The authors of the JICABLE report updated the failure rates for 380kV from the CIGRÉ data collection completed in 2005 with four more years of up to 2009. The authors concluded that the fault rate data was of the same order of magnitude as that reported by CIGRÉ. The authors of the paper also concluded that:

- 1) *The Weibull analysis applied to the described failures shows that the technology is still at the first stage of the bath-tub curve and therefore 380kV XLPE cable systems should be considered as innovative application in meshed grids;*
- 2) *Application of long lengths of 380kV XLPE power cables in the transmission grid results in lower availability, mainly due to longer repair times;*
- 3) *Despite the redundancy in transmission grids, the return of experience results in a high risk position for a TSO;*
- 4) *Opportunities were identified to reduce the risk position towards low if the outage time can be reduced to 8 weeks and the failure rate by a factor of 4.*

The JICABLE paper was written by the engineers of Transmission Operators, Tennet (Holland), 50Hertz (Germany), Terna (Italy) together with authors from Delft University of Technology. The first of their conclusions regarding the life stage of 380kV XLPE cable systems is that it is still innovative, rather than developed. This is perhaps a surprising conclusion as all manufacturing lines for the more fully developed land oil-filled cable have, within the European Union, been dismantled (a much more limited manufacturing capability for land oil-filled cables still exists in Switzerland and Korea, but it is unclear how long these product lines will continue). This decline of the oil-filled cable system manufacturing capability has occurred due to European TSOs switching to adopt XLPE technology at even the highest voltage levels. This has come about as a result of concerns, and environmental legislation, regarding the pollution impact from leaking oil-filled cables. Both an MI and an oil-filled²⁹ cable manufacturing capability for subsea cabling continues in European manufacturing plants. Whilst this manufacturing capability for subsea cables could revert to oil-filled land cable manufacture there is no indication that this is likely to occur as the experience with EHV XLPE circuits continues to go forward.

F-4 UGC cost make-up

This section contains a number of costs for comparative assessment when a technology cost assessment is being performed. These costs are based upon the costs estimates resulting from the case studies (Appendix C) where cost assessments were made on the basis of installing cables between real locations and across actual terrain.

In order to provide costs on a comparative basis between technologies the following point-to-point route lengths were agreed by the team members to be suitable for a comparison to be made. These route lengths were 3km, 15km and 75km.

It can be seen from the case study costs that the type of terrain (urban or rural) plays a significant role in the cost of direct burial of 400kV cable systems. Most cable installations are set in urban areas where it is either impracticable or impossible to install an overhead line along the same route.

²⁹ Even though they both have a paper insulation impregnated with a hydrocarbon oil, oil-filled cable and mass impregnated cable system designs differ in their constructions and capability and the reader should be careful not to confuse the two system types.

The main area of interest for this report is the use of underground technology as a replacement for overhead line in the rural or less densely populated environments where OHL may be installed. It was therefore decided that the costs used to compare technologies should be 50% rural (case study 3) and 50% rural hilly (case study 2).

In order to ensure that the reader is able to gain an appreciation of costs for the urban areas it was decided to assume that all routes consider a sensitivity analysis set between 100% rural to 100% urban, enabling these outer values to be displayed in the study results.

This section therefore contains the following sets of results which have also been extracted and shown graphically in the main report. The following data is based upon data collected from the case studies and presented in graphical form in the main report.

For underground cables, variable costs cover those cost items which principally vary by route length. Examples would be the length of the cable supplied, the number of joints, the length of trench excavated and the cost of the haul road running alongside the excavations.

For the purposes of this report a “special construction” is any area which deviates from one of the standard trench and swathe arrangements (Figure 31, Figure 32 or Figure 33). The need for special constructions may occur at locations where excavation is not possible and alternative constructions are required such as directional drilling or cable bridges over roads, rivers or railways. The quantity of special constructions may be expected to vary with length and by location. The cost of these constructions can be significant to the lifetime price. In some situations, the cables for a particular project are selected because of their unique ability to be used within or upon a special construction necessary to complete a route. For the case studies the cost of special constructions raised the cost of materials and installation by up to 6.4%. This percentage value has been used to calculate the cost of special constructions.

The total cost of easements to landowners will increase with length, as will the public relations and project management requirements of the transmission operator.

Both losses and maintenance costs can be largely considered to be variable costs, which increase with circuit length.

Fixed cost for UGC projects are considered to be those associated with the terminal compounds.

There has been some discussion between the authors as to whether the cost of terminal compounds should be included in the price of installing an underground cable route. Two considerations are uppermost, to either:

a) exclude the cost of termination compounds on the basis that if underground cables were installed in place of overhead line they would reach from one substation to the next without the need for a termination compound, or

b) include the cost of termination compounds as it may reasonably be expected that, in the UK, any cost differential between overhead line and underground cable will lead to a hybrid connection containing a majority of overhead line with short lengths of cable (in comparison to the overall length of the circuit) installed. When only considering short lengths the cost of the termination compounds has a more significant impact on the total cost of the project as it is a fixed cost element.

It was decided to include the cost of terminal compounds both for the reasons given in (b) above and because the reader could remove these terminal compound costs and recalculate the lifetime cost from the data provided in this report.

The following is a description of the make-up of the costs associated with an underground cable project.

| AC underground cable (direct-buried) | |
|---|---|
| Cable terminal compound | The build cost of supplying and erecting a sealing end cable terminal compound at each end of the cable route. This is considered by the report as a fixed cost for the project as it is not dependent upon route length. |
| Cable terminations and testing | The build cost of supplying and erecting cable outdoor terminations (sometimes called outdoor sealing ends or air terminations) within the compounds at either end of the cable route. The cost also includes the cost of testing the route. Whilst there is some variation in the cost of testing, based on route length, this value has been included as an end cost and therefore a fixed cost for each length. |
| Total fixed build costs | A |
| Special constructions | Special constructions have been described in Appendix F-2.19. As a result of the case study examples, a value for the special constructions for this report has been set at 6.4%. However, it should be recognised that this contingency may in practice be unused or exceeded, dependent upon a particular project, and is only likely to be accurate on a particular project by chance. The value for special constructions is 6.4% of the sum of the costs of all materials, fixed and variable, their installation and testing, the allowance for the reactors and the cost of the termination compounds |
| Build contingency | For the underground cable section the build contingency is 15% of the sum of the costs of: all materials fixed and variable and their installation and testing, the allowance for the reactors and the cost of the termination compounds (that is, the same base cost as the special constructions). This allowance is provided for costs which may be project-specific and have not been allowed for elsewhere. It may include such items as the additional costs of excavating difficult soil types (e.g. rock), accommodation of existing services and the cost of diversion, dewatering, contaminated soils (e.g. asbestos, foot and mouth animal burial sites), cost of recovering unexpected archaeology, unforeseen delays, project overrun and bad weather, route diversions, night working and increased security. The risks of all of these items may be expected to increase with project length. There is also some comfort in a build contingency for changes in costs, such as metal prices and duration. |
| On-route cable system materials | This includes the cost of the cable materials to be supplied for the project including all cables and joints. |
| On-route cable installation | This includes the cost of installing the cable between terminal compounds in one of the three arrangements of cable trench cross sections. This value is adjusted for either |



| | |
|---------------------------------------|--|
| | rural or urban excavation but assumes that the ground is readily removable by a back-hoe excavator. This cost is included in the variable cost category and assumed to be directly proportional to length. |
| Reactor costs | The costs of reactive compensation. This is the only cost allowance made for the use of equipment to modify the network in order to accept one or more long cable routes. It is recognised that there may be a need to include other equipment, such as that necessary to provide system voltage stabilisation, but the size, location, extent and cost of such equipment is both network and location dependent, and thus has not been included in this cost study. In order to make some provision for reactive compensation, an allowance has been made in proportion to cable length for the 3km, 15km and 75km options. This cost, as provided, will vary with length and is therefore categorised as a variable cost. |
| Project launch + management | Prior to the construction of a project, it would be necessary for the transmission owner to carry out a number of activities. These could include conducting routeing surveys, taking of soil samples and some predesign of any special constructions in order to prove route feasibility. Publicity, notifications and stakeholder consultation would be required, including negotiations over access to land and the purchasing of easements. The transmission owner may also employ external third-party bodies such as auditors and health and safety consultants, and there would certainly be costs associated with legal considerations and on-site supervision, site engineers responsible for safety, and possibly head office support costs. In discussion with National Grid the authors have concluded that these costs amount to around 20% of the total build cost (including 15% contingency but excluding the special constructions). The above activities are considered a cost that varies with the length of a cable project, and therefore have been categorised as a variable cost by this study. |
| Total variable build costs | B |
| Total build costs | C = A + B |
| Power losses | Costs associated with having generating plant available to generate the energy losses (described further in Appendix D). |
| Energy losses | Costs associated with the fuel burned in the power station to supply the conductor losses (described further in Appendix D). |
| Operation and maintenance | The cost of maintaining the underground cables |
| Total variable operating costs | D |
| Lifetime cost | E = C + D |

F-4.1 UGC cost sensitivities

The following is a description of the sensitivity analyses performed on the cable costs.

- Route length, $\pm 50\%$ – A change to the route length would at first appearance to be a rather strange sensitivity to examine. However, there are a number of fixed cost elements which will not vary with length and this means that the sensitivity of the lifetime cost to a 50% route length change is always lower than 50%. Lifetime cost is most sensitive to route length. Cable routes which do not pass in a straight line due to placements in roads or following field boundaries can incur significant costs over and above the most direct route.
- Installation base costs, $\pm 50\%$ – The cost of installation may also vary as a whole; this may arise as a result of market demand from a limited number of installation companies in the UK. This demand is not only driven by National Grid but also other electricity companies and other utility activities such as water, gas and general construction. The installation base cost is calculated as the total of the cost of all cable installation activity along the route, plus the cost of installing the terminations and on-site testing. The value is flexed by $\pm 50\%$ to indicate the sensitivity of the lifetime cost to the costs of installation.
- Cable system material base costs, $\pm 50\%$ – The cost of materials is calculated for each sensitivity and represents the total cost of all imported materials from the supplier for the project. It is a market phenomenon that global demand and manufacturing capacity will affect the cost of materials. The cost of materials may also change due to foreign exchange. The sensitivity of the lifetime cost to these world market effects is demonstrated by flexing the cable system material costs by 50% in either direction.
- Terrain (100% rural through 100% urban) – The nature of the terrain over which the cable route is running. This does not refer to rock content but assumes that the trench is to be installed in a shuttered trench which may be reasonably easily excavated by mechanical means. The designations are rural (based on the prices for the Mendip case study) through to urban (based on the Avonmouth case study). The baseline case is 50% of each of these terrains.
- Copper price, $\pm 50\%$ – Copper is the most significant material cost in a cable build and is often quoted by manufacturers and purchasers as a significant cost item in the cable cost make-up. Copper is purchased on the metals market and a base cost of USD 8900/tonne has been used to arrive at cable prices.
- Average loading 34% of the maximum transmission capacity, $\pm 50\%$ – Average loading is based on National Grid's statistical load figure for major plant based on an average plant load, one standard deviation above the mean.
- Special constructions, $\pm 50\%$ – The cost allocated to Special constructions is calculated based upon a percentage of the capital cost of construction. The value of this percentage is shown as a value in £m and the sensitivity of the lifetime cost is calculated by flexing this value by $\pm 50\%$.
- Drum length 800m, $\pm 50\%$ – The length of cable installed from a drum, i.e. the distance between joints. This figure is of interest because the number of joints and joint bays will have an impact on the installed price. Manufacturers are offering ever longer lengths of cable. It should be noted, however, that any change in the cost of transporting and lifting

fewer but heavier and larger drums has not been factored into the calculation.

- Losses, ±50% – The calculations of the power and energy losses for power cable are given in Appendix D .

F-5 List of costing sources

This section outlines the sources of each of the above-described costing and cost sensitivity items. It describes the levels of confidence which may be placed in the figures which contribute to the costing estimates for this technology.

Information on prices for materials and/or installation was received from:

- ABB (Sweden)
- General Cables (Silec) (France)
- Nexans (France)
- Prysmian Cables and Systems (UK Office)
- Subkabel (Germany).

National Grid also supplied information on supplier prices based on tenders they had received and projects completed and in progress. The supplier information provided by National Grid included separate information from some or all of the suppliers listed above. The material price information from suppliers and from National Grid were broadly comparable, and the lowest prices were within a 5% difference.

In order that prices could be compared from one supplier to the next and the lowest supply price assessed, the following baseline information was given to suppliers.

| Material | Price USD/tonne |
|-----------|--------------------|
| Copper | 8900 |
| Aluminium | 2300 |
| Lead | 2400 |

Exchange rates for use by estimators were advised as being:

| Conversion | Rate |
|------------|------|
| GBP / EUR | 0.88 |
| EUR / USD | 1.4 |

Installation prices for installation activities were obtained from one supplier with very large experience of project management and installing EHV cables in the UK for all of the transmission companies in the UK and at lower voltages for the electricity distribution network operators.

In order to obtain prices, the costs of materials and installation were amalgamated to obtain the lowest budgetary cost as a bottom-up cost build. National Grid costs gave a top-down estimate and included National Grid’s own costs which were included in the lifetime costs.

Both the bottom-up costs (taken from case study estimates) and top-down costs (from transmission company projects) were used to build the cost estimates compiled in this report for the 3km, 15km and 75km lengths.

The cable company, Sudkabel found the installation requirements in the UK sufficiently singular that they published a technical paper³⁰ at JICABLE 2011. This paper describes the installation of a single 10.3km long 275kV cable circuit in Liverpool. The initial investigation³¹ by National Grid commenced in early 2005. The new cable circuit project took almost five years to bring to completion from initial planning.

F-6 Anticipated future developments

Low thermal resistivity backfills

Transmission cables carrying large electrical current generate significant heat. When the cables are buried in the ground the heat generated, principally by the conductor, must be capable of escaping into the environment. If this is not allowed to happen the temperature of the conductor will rise uncontrollably until a failure occurs due to the cable overheating.

The soil surrounding the cable trench and the backfill around and over the cable has the effect of a thermal blanket over the cable. This blanket covering reduces the amount of heat that can escape from the cable into the atmosphere and thus a buried cable can carry less current (on a continuous basis) than a cable installed at surface level in free air.

When buried, 400kV cables are laid into the cable trench in groups of three (the three phase cables). Normally, the three cable will carry the same, or nearly the same, current and thus will heat up together in the same trench. The cables are sufficiently close together that they will feel the temperature rise in the soil due to one another's mutual heating. There are limitations on the distance that cables can be separated by without incurring significant additional costs either due to the cost of excavating and supporting a wider trench or the costs of changing the cable design to cope with the electrical inductive effects of increasing the separation between conductors and cable sheaths.

As a result the cable designer must base the cables' thermal performance not only on the materials used to construct the cable but also the backfill and soils placed above and around the cable. It has been the practice in the UK to adopt a thermal resistivity of 1.05mK/W for soils in the winter and 1.2mK/W for soils in the summer. The difference between these two values is an allowance for moisture within the soil. Damp soils have a lower thermal resistivity (i.e. they conduct heat more readily) than dry soils; the dangers of this were revealed in July 1962 when two breakdowns³² due to thermal instability occurred on a double-circuit 132kV connection between Belvedere and Sydenham in South London. The cables had been carrying sustained and heavy loadings during a relatively dry spring and summer. The soil thermal resistivity can more than double, increasing still further the conductor temperature which in turn increases the volume of soil with a higher thermal

³⁰ "Challenges at the Planning, Development and Performance at the 275kV XLPE Cable Project in the City of Liverpool", Ebert, S. et al. Paper B.5.4, JICABLE, 2011

³¹ National Grid commenced enquiries to receive bids for preliminary engineering surveys in April 2005 (CCI internal records)

³² "Natural and forced-cooling of HV underground cables: UK practice", Williams D. E., IEE Proc, Vol 129, Pt. A, No.3 May 1982

resistance causing the conductor temperature to increase further. This circular effect is known as thermal runaway.

The volume of backfill which transmission engineers in the UK consider will be subject to drying is that which rises to a temperature of 50°C or more (i.e. the volume of backfill within the 50°C isotherm). It was found that by selecting a suitable sand with good compaction and low void ratio and mixing this with a small volume of cement (14:1) it may be used as a backfill which exhibits a thermal resistivity which does not exceed 1.2mK/W when fully dried out. This backfill material, known as cement bound sand (CBS), has since been extensively used in the UK as a backfill when installing transmission circuits.

Alternative materials have been used, mainly overseas, for a similar purpose. So-called “fluidised thermal backfills”³³ (FTBs) exhibit similar properties to CBS but are more pourable, rather like a wet cement slurry, than the CBS which is similar in consistency to a wet sand. FTBs have been used which offer lower stable³⁴ thermal resistivity than CBS.

A paper³⁵ presented at JICABLE 2011, indicates a concrete mix has been developed with a dry thermal resistivity of 0.33mK/W (the paper actually uses the inverse unit of thermal conductivity of 3 W/mK). This material, traded as Powercrete™, has been found to be almost three times the cost of cement bound sand. The Powercrete™ material also requires the use of a protective duct encasement. Never-the-less the development of such a low thermal resistivity material may be of use where ratings are limited by poor natural soil qualities or where a concrete duct encasement would normally be installed and some additional depth required. This is not unusual in urban installations.

The use of PowerCrete™ or PowerCem™ materials (the latter is used inside ducts) on higher capacity circuits may also assist by enabling the highest rating considered by this report to be carried by a 2500mm² rather than a 3000mm² cable or for a longer emergency rating to be sustained if required.

Y-branch joints

A development in Asia is the Y-branch joint. This is a joint where one conductor may be connected to two others. This type of joint has been used at voltages up to 275kV and has been used to avoid the need for switchgear to allow a branch connection or T-off (Figure 47).

In terms of this report, an opportunity exists for transmission operators to use this type of joint to overcome the more onerous rating requirements along a cable route.

It is common practice for the size of the conductor in a cable to be based upon the position where it is most difficult to obtain the rating. This can lead to a number of adverse cost events:

- a) a significant portion of the cable may be installed with an oversize conductor
- b) a less than optimum cable size to trench width must be selected
- c) a very costly special construction is required at the rating restricted position.

³³ “Fluidised thermal backfill for increased ampacity of underground power cables”, P. D. Radhakrishna et al., Paper A. 2.2, JICABLE 95, Paris, 1995

³⁴ The term “stable thermal resistance” refers to the highest thermal resistance of the compacted material when fully dried out.

³⁵ “A New Backfill Material with an Extremely High Thermal Conductivity”, Brakelmann H. et al., paper C.10.2, JICABLE 2011, Paris, 2011.

Figure 47 – Schematic Y-branch joint
“Y” Joint Internal Schematic

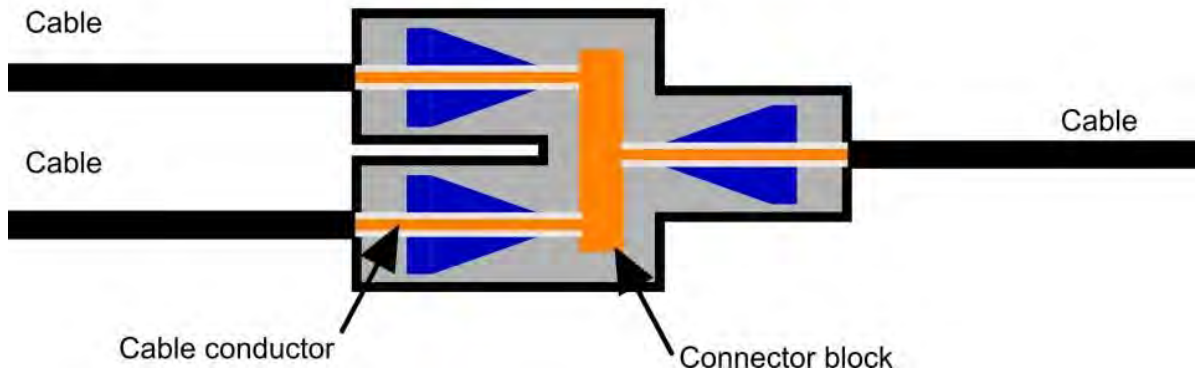

Underground Cables

The Y-branch joint would allow the number of cables to be doubled locally for example to cross deep beneath a river or road or to pass through an area of constricted width.

Y-branch joints for EHV cables are not available from European manufacturers but technical papers³⁶ have been published describing their characteristics.

Figure 48 – Example use of Y-branch joints to maintain cable ratings

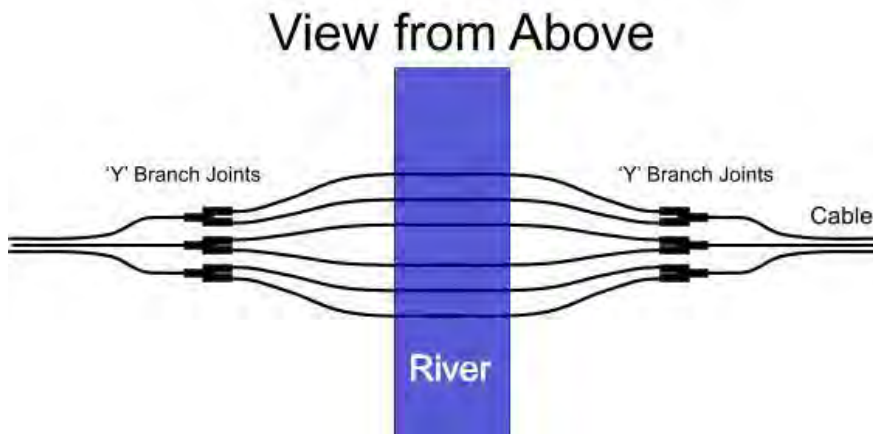

If a single cable conductor's load is shared equally between two equally sized conductors the load on each conductor is halved and the total heat loss is also halved. This allows the cables to be buried significantly deeper, or the phase cables to be placed closer together, before the temperature of any conductor rises to an unacceptable level.

Polypropylene insulation

Developments have been ongoing in the use of alternative polymers to polythene for EHV cable. One of the promising materials is polypropylene which has a higher melting point than XLPE. The higher melting point and operating temperature would allow cables conductors to operate at a higher temperature.

³⁶ “Upgrading Quality of 275kV Y-Branch Pre-Fabricated Transition Joint”, Nakanishi T. et al., JICABLE 07, Paris 2007

National Grid has sponsored Southampton University to perform some studies to determine what benefits, if any, there might be for the future development of a higher temperature insulation. Southampton University has published two papers^{37, 38} considering the use of high temperature conductors. The main findings of these papers were that at the higher operating temperature:

- no significant cable rating increase for cables in an air-cooled tunnel would be provided
- at a conductor temperature of at 150°C the cable rating would increase by approximately 30%, but more onerous cable losses would make the load capacity increase less attractive
- there would be a significant increase in the post-fault emergency ratings.

Superconducting cables

It is a physical phenomenon that the resistance of a conductor to the passing of electrical current increases with temperature. Similarly, if the conductor is cooled, the resistance of the conductor falls. If a copper conductor is cooled to near absolute zero -273°C , then the resistance of the conductor falls very close to zero, and in a superconducting material the resistance actually is zero and current can flow without generating any heat from the conductor and can pass through the conductor without any electrical resistive losses. However, maintaining the conductor at such a low temperature requires the use of the specialist cryogenic plant, and the lower the temperature the more difficult it is to maintain.

However, the discovery of other alloys which exhibit superconductivity at or above the temperature of liquid nitrogen has made the development of superconducting cables more attractive. These high temperature superconducting (HTSC) materials (even though they use a liquid nitrogen coolant at a temperature of -196°C) have made it possible to construct a number of relatively short length demonstration projects showing high power transmission.

Table 10 shows some details of HTSC applications extracted from a previous report³⁹ on the feasibility of using this for underground cables.

Table 10. Details of some HTSC cables and applications

| Year | Design | | | | | | Application | | |
|-------|-------------|--------------|---------------|--------------|--------------------|------------|-------------|-----------|-----------------------------------|
| | Length M | Power MVA | Voltage kV | Current A | Cable type | | Joint | Type | Location |
| | | | | | Cold or warm | Cores # | | | |
| 1999 | 50 | 400 | 115 | 2000 | WD | 1 | yes | test | Italy, Milan HV lab ⁴⁰ |
| 2001– | 30 | 27 | 12.4 | 1250 | CD | 3 con | no | grid demo | USA, Carrolton, |

³⁷ “Impact of moisture migration on the current rating of high operating temperature cables”, Pilgrim J. et al., paper C.9.6, JICABLE 11, Paris, 2011

³⁸ “Investigation into the benefits of installing high operating temperature cables in tunnels”, Pilgrim J. et al., paper C.10.1, JICABLE 11, Paris 2011

³⁹ “Feasibility study for 500kV AC underground cables for use in the Edmonton region of Alberta, Canada”, B. Gregory, A. Williams, Cable Consulting International, Feb 2010, <http://tinyurl.com/7no2u5p>

⁴⁰ M. Nassi et al., ‘Design Development and Testing of the First Factory Made High Temperature Superconducting Cable for 115 kV – 400 MVA’, Paper 21-202, CIGRÉ Conference 1998, Paris

| Year | Design | | | | | | Application | | |
|-----------|--------|-------|---------|---------|------------|-------|-------------|-----------|---|
| | Length | Power | Voltage | Current | Cable type | Joint | Type | Location | |
| 2007 | | | | | | | | Georgia | |
| 2001–2003 | 30 | 104 | 30 | 2000 | WD | 1 × 3 | no | grid demo | Denmark, AMK SS, Copenhagen ⁴¹ |
| 2002 | 100 | 115 | 66 | 1000 | CD | 3 | no | test | Japan, Yokosuka test site ⁴² |
| 2003–2005 | 500 | 133 | 77 | 3000 | CD | 1 | no | test | Japan, Yokosuka test site ⁴³ |
| 2005–2006 | 100 | 50 | 23 | 1260 | CD | 3 | yes | test | Korea, KEPCO test centre ^{44, 45} |
| 2006 | 300 | 69 | 13.2 | 3000 | CD | 3 con | yes | grid demo | US, Bixby, Columbus, Ohio ^{46, 47} |
| 2006–2009 | 350 | 48 | 34.5 | 800 | CD | 3 | yes | grid demo | US, Albany, NY |
| 2008 | 610 | 574 | 138 | 2400 | CD | 1 × 3 | no | grid demo | US, Holbrook, Long Island Sound ^{48, 49} |
| 2010–2011 | 300 | 62 | 13.8 | 3000 | CD | 3 con | no | grid demo | US, Manhattan, NY City |
| 2011 | 1,760 | 48 | 13.8 | 2000 | CD | 3 con | yes | grid demo | US, Labarre-Metairie SS, Louisiana, New Orleans |

Notes:

CD: cold dielectric; a cable in which the conductor(s) and insulation is cooled to LN2 temperature.

WD: warm dielectric; a cable in which the inner conductor contains an LN cooling duct and is surrounded by the cryostat. Everything outside the cryostat is nominally at “room” temperature. The insulation is applied over the cryostat and so is named a “warm dielectric”.

Cores:

1: one single-core cable manufactured for laboratory test.

1 × 3: three single-core cables usually manufactured for a demonstration trial application connected to a utility or industrial “grid”.

3: a three-core cable in which the three cores are housed within a common cryostat.

3 con: a single cable comprising three concentric phase conductors separated by annular layers of insulation. “Triax” is one trade name.

⁴¹ J. Ostergaard and O. Tonnesen, “Design, Installation and Operation of World’s First High Temperature Superconducting Power Cable in a Utility Power Network”, Paper 21-205, CIGRÉ Technical Conference 2002, Paris

⁴² S. Honjo et al., “Verification Tests of a 66 kV High-TC Superconducting Cable System for Practical Use”, Paper 21-202, CIGRÉ Technical Conference, 2002, Paris

⁴³ M. Ichikawa et al., “Demonstration and Verification Test Results of 500-m HTS Power Cable”, Paper B1-104, CIGRÉ Conference, 2006, Paris

⁴⁴ S. I. Jeon, et al., “Development of Superconducting Cable System for Bulk Power Delivery”, Paper B1-06, CIGRÉ Conference, 2006, Paris

⁴⁵ H. M. Jang et al., “Type Test Results for 22.9kV 50MVA HTS Cable System in Korea”, Paper B1-108, CIGRÉ Technical Conference, 2008, Paris

⁴⁶ D. Lindsay et al., “Installation and Commissioning of TRIAX HTS Cable”, Paper A.3.2, Jicable 2007 Conference, Versailles

⁴⁷ D. Lindsay et al., “Operating Experience of 13.2kV Superconducting Cable System at AEP Bixby Station”, Paper B1-107, CIGRÉ Conference, 2008, Paris

⁴⁸ J.-M. Saugrain et al., “Superconducting Cables – Status and Applications”, Paper A 3.1, Jicable 2007 Conference, Versailles

⁴⁹ F. Schmidt et al., “Development and Demonstration of a Long Length Transmission Voltage Cold Dielectric Superconducting Cable to Operate in the Long Island Power Authority”, Paper A.3.4. 2007 Jicable Conference, Versailles

HTSC technology is, however, still a long way from a practical realisation that will offer an alternative transmission technology to those discussed in this report.

The complexity of the design of the transmission cable, its joints and terminations to reliably maintain a cold conductor at elevated voltage over tens of kilometres has yet to enter commercial availability and for this reason a feasibility or cost estimate has not been provided in this study.

Appendix G Technology – Subsea Cables

G-1 Technology description

Since the 1950s a variety of cable designs have been used for HVDC power transmission. The main types that have been used have either been paper insulated cables or solid dielectric cables.

Paper-insulated subsea HVDC cable designs have always used a paper impregnated or immersed under pressure from either an oil or gas. The paper cable types are high pressure oil filled (HPOF), single core oil filled (SCOF), mass impregnated (MI) and gas filled. A more recent development is the polypropylene laminate paper insulation.

For the purposes of this study we shall consider only the single-core mass impregnated and single-core extruded dielectric cables.

For subsea applications copper conductors are preferred as these conductors are able to carry more current for the same cross-sectional area compared to aluminium, which leads to a smaller cable diameter. Copper conductors are also preferred for salt water applications because, should the cable be damaged and water come in contact with the conductor, then copper has a better corrosion resistance than aluminium.

Figure 49 – A cable paper lapping machine applying paper tapes

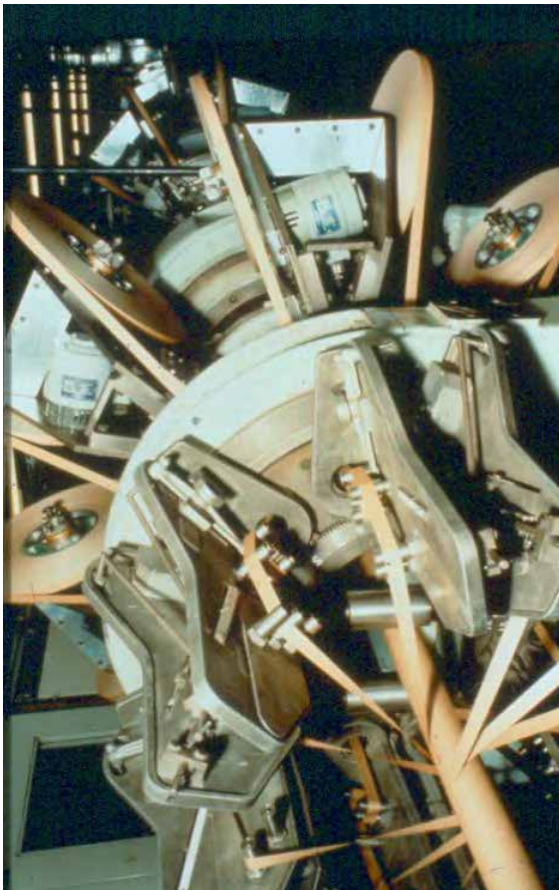

(Courtesy of Cable Consulting International)

The mass impregnated HVDC cable is the most prolific subsea cable type. In this cable design a copper conductor is insulated by means of paper tapes lapped around the conductor under controlled humidity conditions. Figure 49 shows a paper lapping machine. The paper lapper also applies the semi-conducting conductor and insulation screens which provide smooth concentric surfaces across which the DC voltage is applied. The tapes are applied in a controlled low humidity environment to restrict the absorption of moisture into the tapes. The cable is then transferred to an impregnation tank for vacuum drying and impregnating with insulating compound.

As the impregnation process is not a continuous manufacturing process but one in which the two ends of the cable must be contained within the vessel, the capacity of the impregnation vessel is normally the limiting factor on the length of cable that may be manufactured without a joint. When designing a cable factory, the capacity of the conductor storage turntable is matched to the impregnation vessel. Pads of paper tapes and screening material are replaced as they are consumed during production to enable continuous insulation of the conductor. The impregnation vessel contains an internal turntable onto which the cable is laid. The walls and lid of the vessel are designed to withstand vacuum and thus the impregnation vessel is both large and sturdy. Depending on the cable size and the capacity of the impregnation vessel, a single cable length may be in the order of 40km, without a joint, and the turntable within the impregnation vessel must be capable of handling several thousand tons of cable.

The cable is then heated and dried under a vacuum within the vessel until sufficiently free of moisture before hot impregnating oil is introduced into the vessel. The oil fills the vessel and impregnates the paper tapes and completes the impregnated paper insulation.

Figure 50 – Subsea cable armouring process

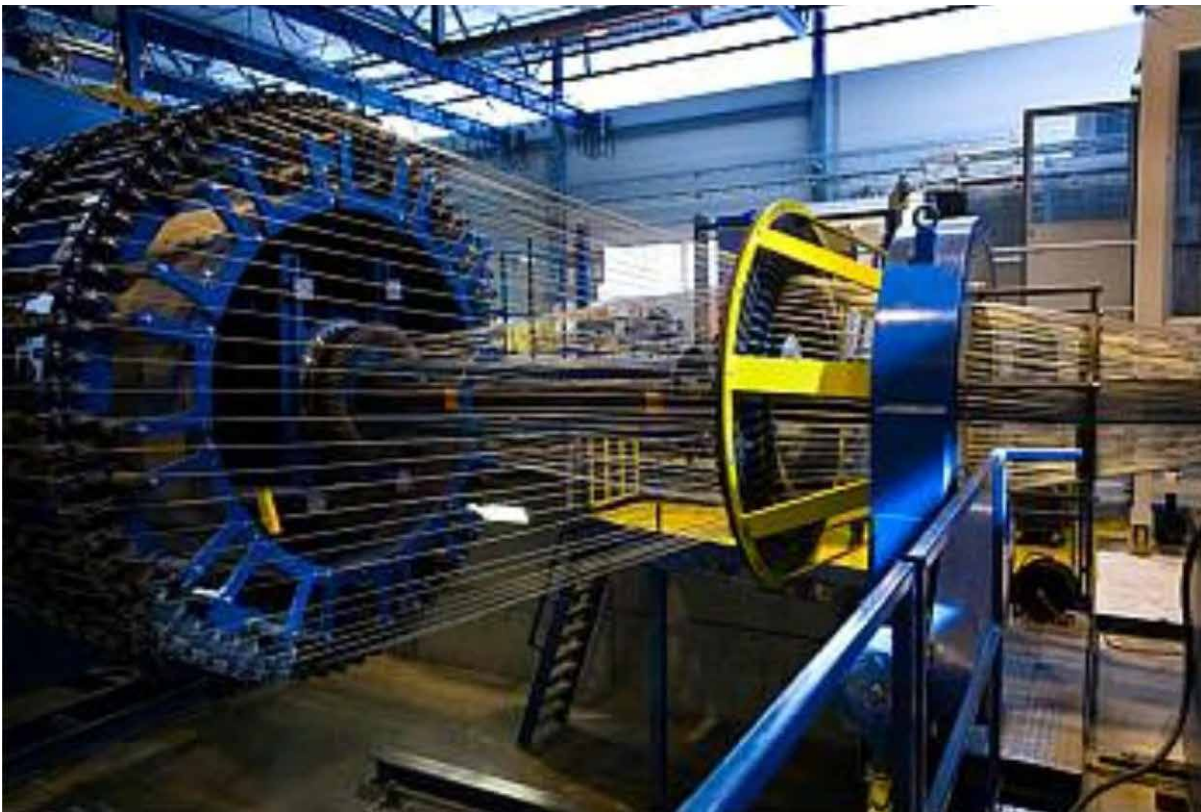

Following impregnation and cooling the cable core (conductor plus insulation is known as the core or insulated core) emerges from the tank and passes through a lead press which applies over the core a watertight lead sheath which provides a complete radial water block. The lead sheath is preferred to aluminium due to its much higher resistance to salt water corrosion. Aluminium sheathed subsea cables rely very heavily on the performance of their corrosion protection coverings. Compared to a land cable, a subsea cable lead sheath may be expected to receive additional duty as a result of vibrations and forces during installation and possible movement and pressure loading and strain as a result of immersion and burial.

Over the top of the lead sheath a polymeric (almost invariably polythene) sheath is applied.

Armour wires are then applied (Figure 50). This armour largely consists of layers of steel wire capable of withstanding the tensile forces experienced by the cable during installation. Galvanised steel wire armour is used for most applications. Resistance by the cable to abrasion and impacts may be increased by the application of two layers of armour wire. However, if the cable is to be capable of being coiled down, rather than always handled by turntables (Figure 51), the multiple layers of wire must be applied in the same direction (lay). This is required because, when coiling, a twist is applied to the cable and this twist may not physically be applied if the wire armours are in opposite lay directions.

Figure 51 – Subsea cable on factory turntable.

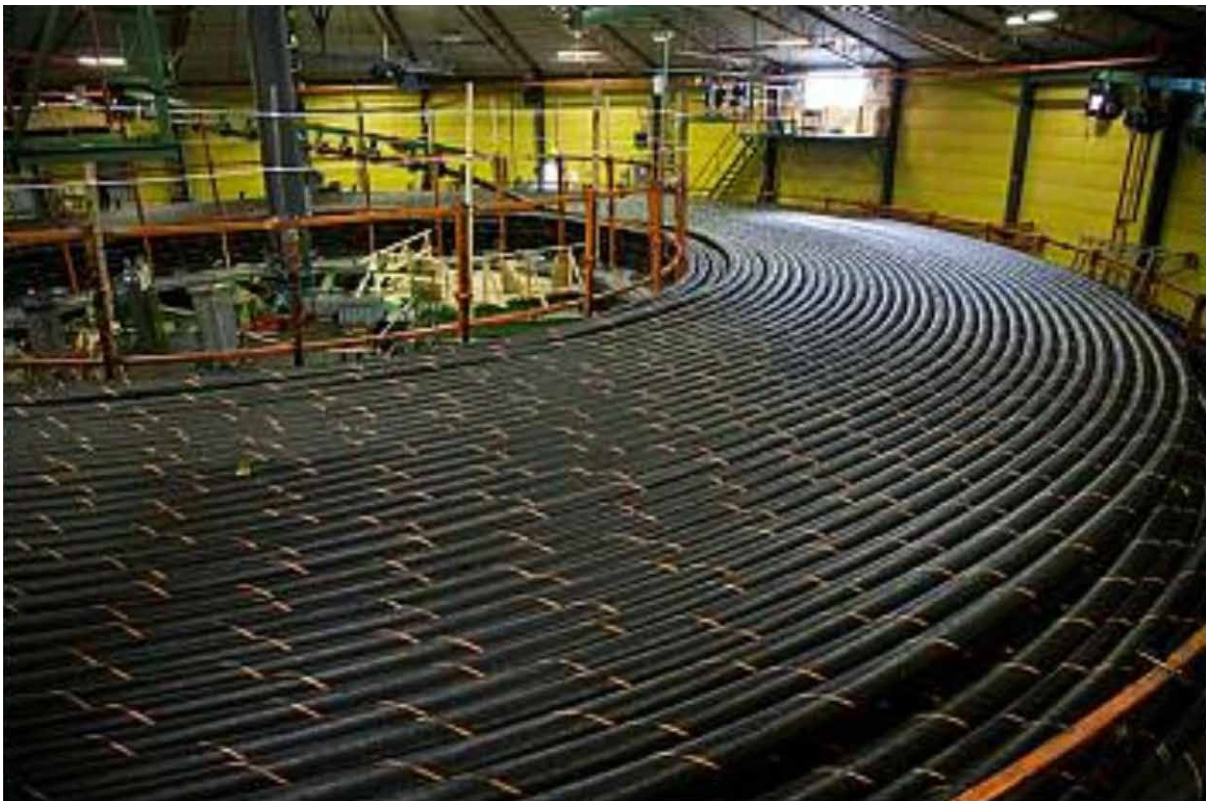

(Courtesy of Nexans)

The armour wires are bound by polymeric rovings (strings) into which may be introduced identifying markings by the use of different coloured rovings. The rovings are generally black with the identifying rovings used being yellow.

The main limitation with paper insulated subsea cables has been the maximum operating temperature. Most subsea paper insulated cables operate with a maximum conductor temperature of 50–55°C. This limit is imposed by the performance of the cable insulation. There is some activity in the market to increase this temperature with the introduction of

PPLP (also known as PPL) insulation designs which may operate at up to 80°C⁵⁰ albeit that none is known to have been installed to date.

A more recent introduction into the market since the mid 1960s is a subsea cable design with an extruded insulation. Initially these extruded subsea cables were used for AC applications. The longest AC connection in European waters is the 90kV AC link between England and the Isle of Man.

For HVDC applications the benefit of an extruded insulation over an impregnated paper insulation is the higher operating temperature (i.e. increased current carrying capacity for a given conductor cross-section). The solid dielectric cables also have the advantage that they need not contain hydrocarbon fluids, such as oil. However, some care must be taken when making much of this issue as the oil inside MI cables is not freely flowing and thus large volumes of the oil will not be expected to escape the cable in the event of cable damage or failure.

It is also common on cable designs with steel wire armour to liberally apply a bituminous compound over the wire armour. However, this compound is not free-flowing from the cable albeit that is in direct contact with the marine environment, and designed to be so.

European manufacturers have produced cables with an extruded insulation having a maximum conductor temperature of 70°C. This increased conductor temperature enables the use of a smaller conductor for the transmission of energy and therefore a less expensive cable may be supplied for the same energy transfer. However, some European designs are only suitable for use with the VSC type converters where polarity reversal is not a risk and where the maximum transmission voltage is up to 320kV.

Two Japanese manufacturers of extruded HVDC cable use a different insulating compound and have published information on cable designs up to 500kV. Conductor temperatures up to 90°C are permitted and they have performed tests demonstrating a tolerance to polarity reversal and thus a compatibility with both CSC and VSC converter designs. These cables have not, as yet, been installed on a commercial application. At current price levels the cost of shipping long lengths of cable from the Far East, the strength of the yen and the additional import taxation borne by those outside of the EU still leaves European manufacturers in a strong position. However, if demand pushes up prices sufficiently then at some point one may expect either that the Japanese (and/or Korean) products become more attractive and start entering the European market or that additional production facilities are installed within Europe.

The majority of DC transmission circuits have a power transfer capability of less than 1000 megawatts (MW) and are point-to-point merchant connections. If DC connections, either installed underground or subsea, are to be designed to significantly replace or reinforce the existing HVAC OHL technology then it will be necessary to consider much larger power transfer capability.

The power transfer capacities required by the report terms of reference required consideration of 1000MW, 2000MW and 3000MW connections. These are single circuit ratings, and thus additional consideration has been given to additional ratings of 4000MW and 6000MW. The costs given in this report cover this range of DC subsea cable connections.

⁵⁰ "Solid DC Submarine Cable Insulated with Polypropylene Laminated Paper (PPLP)", Hata, R., SEI Technical Review, Number 62, June 2006, <http://tinyurl.com/7946qo8>

In order to transmit large amounts of DC energy by subsea cable the most cost-efficient arrangement utilises one or more bipole connections. A bipole connection consists of one cable at a positive DC voltage (positive pole) and a second identical cable at an equal but opposite negative voltage (negative pole). Figure 52 shows a single bipole connection and Figure 53 a triple bipole connection. The number of bipoles would be altered to meet the required rating. It should be noted that a voltage of 400kV has been selected for CSC type converters and 320kV for VSC converters. These voltages have been selected as the conductor size of the MI and solid dielectric cables will be the same if MI cables are used on CSC, and solid dielectric cables are used on VSC converter systems. It should be noted that MI cables may be used at higher voltages, particularly for long-distance transmission, where cable losses become increasingly significant.

The actual number of bipoles used in a particular project will depend upon the capacity or number of circuits required.

Figure 52 – Single bipole arrangement

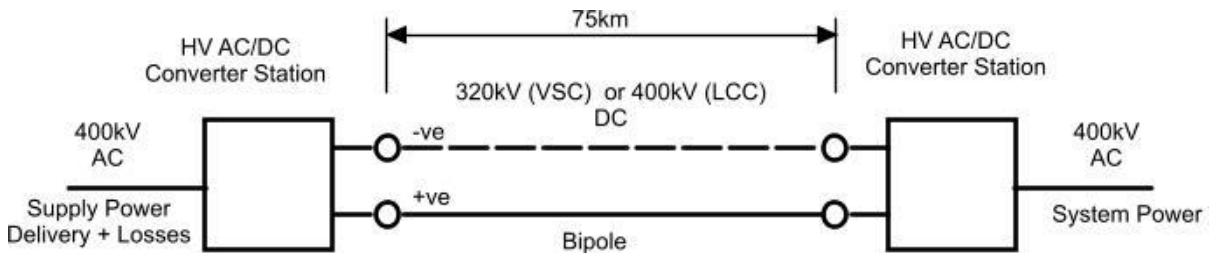
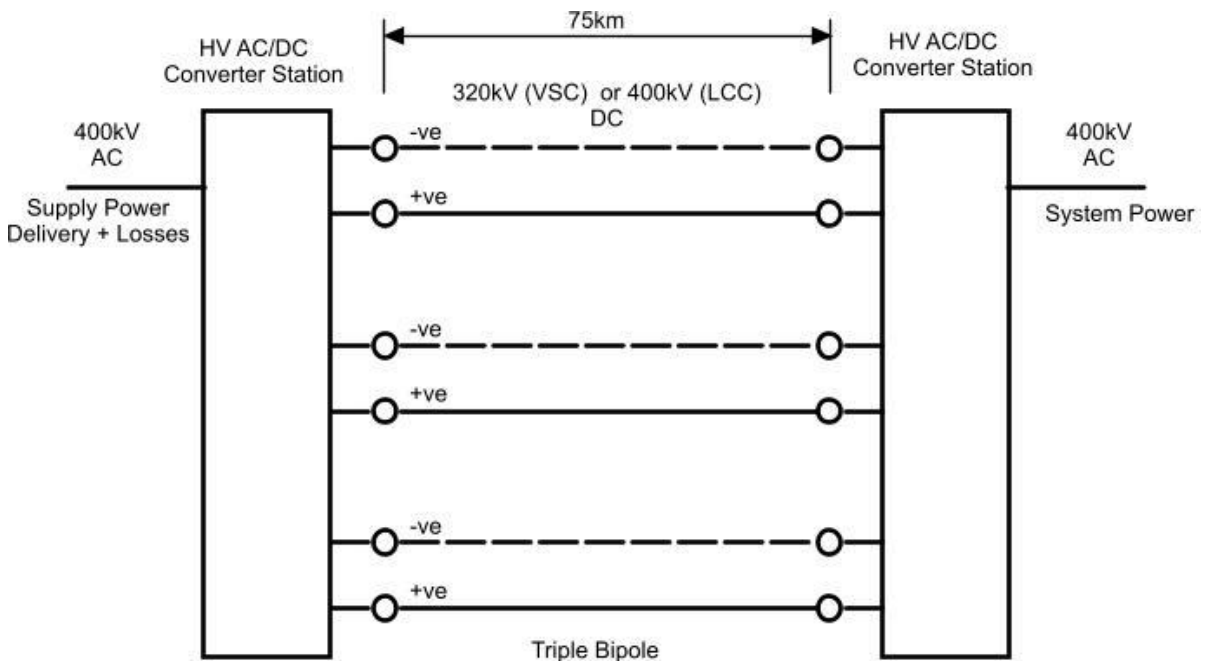

Figure 53 – Triple bipole arrangement



Subsea Cable

Each bipole would be buried beneath the seabed where possible to a typical depth of 1.0m as indicated in Figure 54. When installing more than one bipole it is good practice to separate each bipole by a comfortable distance of several hundred metres. This allows the cables to be buried safely without the installation vessel risking damage to a previously

installed bipole during installation of another. It also decreases the risk of more than one bipole being damaged by a single third-party event, such as an anchor drag.

Figure 54 – Seabed burial arrangement of a bipole

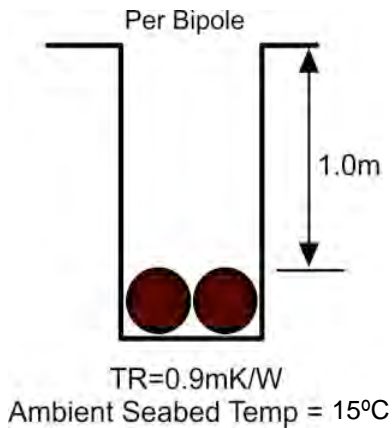

G-2 Civil works and project feasibility

Once an initial commitment has been made to install a subsea HVDC connection, desktop studies must be performed. It is at this stage that consultation with the general public and stakeholders usually commences.

A marine survey will be performed to try to establish from existing records and charts details of existing pipelines, other cables, fishing activity, subsea obstructions (e.g. wrecks), areas of dredging, seabed contamination, military activity, ammunition dumps and gravel and sand extraction etc. Areas likely to prove problematic should be avoided where possible.

Details of the sea floor, its make-up, movement and depth, are all important considerations for the power cable bipole.

The sea bed thermal resistivity and the water depth can also place onerous constraints on the cable design to ensure that the cable does not overheat, slide on slopes or be exposed to strong vortex shedding. The crossing of salt flats and peats can require increases in the conductor size of cables, and the presence of bait digging can increase the depth and armour protection needing to be provided to a cable.

Bathymetric maps are available for the waters around the UK but some maps produced by European countries use different chart datum, and caution is necessary when using alternative sources.

Aside from the human inputs of legislation, corporate ethics, regulation, ownership and stakeholdings, the subsea cable installation can also present engineering and environmental challenges. For example, a significant amount of the UK coastline is protected by sea defences and consideration to these defences must be given during both the design (a poor design can damage sea defences) and installation (temporary dismantling of sea defences can create an unacceptable risk). Wildlife habitats abound along the UK coastline and careful consideration towards the size, scope and timing of installation activities can be critical. The same is also true of tourism where activity on the sea front in the summer months holds the least risk for bad weather delays for the project but may unfairly burden a local tourist industry.

The desktop study should also uncover the legal requirements and permits required to access the sites both for on-site survey land and marine work as well as those required for construction.

Marine route surveys should be performed. The level of experience of the survey team and the equipment they use will be key to the quality and accuracy of the survey performed and the information provided.

When performing a marine survey it is possible to obtain accurate water depth charts (bathymetric charts) from sonar data (underwater sound wave echo location data). Sonar of the correct frequency (the higher the frequency the better the data but the shorter the range) should be capable of detecting large obstructions and services on the sea floor.

Where waters are sufficiently deep that the risk of damage due to third-party intrusion (anchors and fishing) is low, burial of the cable beneath the sea floor may not be necessary. This report considers that any installation in UK coastal waters would be at risk of damage due to third parties, and thus both jetting and plough burial have been included in the costs, along with a contingency for a limited extent of other measures such as rock placement or concrete matting.

Sub-bottom profiling may be performed using a frequency-modulated sonar which is able to penetrate the sea floor to indicate layers (strata) beneath. The sea floor may appear to be unchanging along the cable route. However, this can be deceptive, and a sudden and unexpected change of sea bed conditions (say from sand to rock) beneath the sea floor can cause damage and delays during the burial process. Sea bed penetrating sonar may also be capable of detecting other buried services such as pipelines and cables.

Sampling of the sea floor to confirm its make-up can also be important to determine the best method to be used to protect or bury the cables. A seabed containing a lot of rock will make burial difficult, and expensive strategies such as rock placement (also known as rock dumping) may be required. Pebble and shingle is difficult to water jet, and areas around the coast of Britain are known to have large waves of shifting pebbles and sand, the troughs of which can uncover cables and leave them suspended between pebble and sand waves. The thermal properties of the sea bed should also be determined.

The cost of all surveys can be established and budgeted within the project and is knowable. This survey cost should be compared with the costs associated with the risks of meeting a problem during installation where the mobilised marine spread with the bipole cable on board costs over £100,000 for each day of delay.

Prior to inviting bidding contractors, it is best practice to perform a detailed and comprehensive survey. The cost of surveys can be reasonably controlled and forecast, and much of the information required to complete the survey is obtainable without venturing on site.

Following the commercial commitment to install a DC subsea cable (the project must include the purchase and installation of HVDC converter stations) the cables are manufactured and loaded onto a cable-laying vessel. The vessel, normally equipped with turntables (although some cables may be coiled down) collects all the cables from the cable factory. Cable-laying ships are versatile vessels which have been developed for the primary purpose of cable collection, delivery and installation. Depending on the vessel's previous engagement it may be necessary, and often is, to modify the type and arrangement of equipment loaded onto the vessel. The duration of the engagement of the cable-laying vessel, its on-board equipment, marine crew and cable specialists is a significant expense, and costs in excess of £150,000 per day are not exceptional. There is also a risk of additional costs being incurred

during the installation process, including problems during cable load-out (loading the cable onto the ship); these delays can be costly, and the vessel is not easily off-loaded or put to other work. Cable-laying vessels are generally in demand and booked well in advance. Vessel delays can thus occur for various reasons and can be of short or long duration. It is important therefore that cost elements for vessel mobilisation, demobilisation, bad weather and sizeable contingencies are included in the budgetary cost estimates.

The bipole cables are laid and buried bundled together, often with a fibre optic cable for control purposes. The method of burial will depend on the sea bed conditions. The most common burial methods are by the use of a plough or jetting.

Following the placement of the cables on the sea bed, a plough is used to pick up the cables. The plough cuts opens the seabed, and the bipole group of cables is fed through a plough blade guide path and installed at the required depth. The trench cut in the sea bed and containing the bipole is allowed to backfill naturally.

Other sea bed conditions are more easily excavated by water jetting. Following the laying of the cables on the sea bed, a remotely operated vehicle containing water jets blows the sea bed away from under the cables. The cables sink under their own weight and this process continues until the bipole group reaches the required depth.

The main reason for burying a cable beneath the sea floor is to prevent inadvertent damage to the cables by third parties and to prevent cable movement as a result of sea currents. CIGRÉ published a technical brochure⁵¹ in 2009 considering third-party damage to underground and subsea cable, and the following is a list of possible activities that could give rise to subsea cable damage:

- anchors and snags (anchors up to several tonnes with varying penetration capabilities)
- dredging (marine sand and gravel dredging/fairway clearance)
- spud pole moorings (secured working platform/barge legs)
- shore or near-shore backhoe (local dredging)
- barge deadman weight (tensioning device falling to sea floor)
- falling/sinking objects (e.g. lost ship's propeller)
- nearby construction (harbour construction, outfalls, piling, near-shore constructions)
- ploughing (burial of other services)
- waste/scrap disposal at sea
- thermal change (thermal outlets from power plants)
- fishing (heavy and light trawling)

Anchor chains in excess of 300m are in use and thus safety of a cable from damage by anchor chains would require a water depth of around 400m although even at this depth there are some specialist vessels that are able to deploy a securing anchor. Figure 6.2 of the CIGRÉ publication showed that a 30t anchor could penetrate the sea bed by in excess of

⁵¹ "Third Party Damage to Underground and Subsea Cables", WG B1.21, Technical Brochure 398, CIGRÉ, Paris, December 2009

5m. The best form of protection is to avoid laying the cable in areas subject to anchoring and the next best is to protect the cable.

Fishing can occur in deeper waters but the depth of penetration of the gear into the sea bed is only around 0.3m.

The cheapest form of cable installation is where the cable is laid unprotected on the sea floor. Any form of protection for the cable increases the cost of the project, and this cost can be significant. However, the cost of damage to a cable can also be significant in terms of time, money and trouble. It is therefore necessary to select the most cost-effective cable protection solution.

The CIGRÉ recommendation is to analyse the risk of damage and to calculate a cable protection index (CPI).

CPI is calculated as being severity × probability × consequence, where the severity of the damage considered, the probability of the damage occurring and the consequences of such damage are each graded between 1 and 5, 5 being the worst.

A CPI of 15 or less is considered to be acceptable, a CPI of between 15 and 25 to require further studies and a CPI above 25 requiring measures to reduce the risk.

The level of protection will depend on the method used, the most common being burial beneath the sea bed with the depth of burial dependent upon the type of sea floor, its hardness, method of burial and the level of protection that each depth of burial affords.

For the purposes of this study and the costs requested from suppliers and installers a required depth of burial beneath the sea floor has been set to at least 1m. Depths of 1m to 1.5m have been used for most if not all recent offshore power developments (wind farms) and interconnectors.

G-3 Application of the technology

HVDC connections are most efficiently employed for very long length transmission of electrical energy. The longest subsea connection in service is the ±450kV, 700MW, 580km connection between the Netherlands and Norway (known as the NorNed project).

Due to the fixed cost of converter stations, the economy of HVDC connections only becomes viable for long lengths. Subsea AC connections are limited by length. Currently the longest AC subsea connection in the UK (and the world) connects the UK mainland to the Isle of Man. This connection is a three-core 90kV AC connection over a distance of 105km but has a power transmission capability of only 40MW. This cable was constructed entirely in the UK and energised in October 2000. Since that date, both the UK manufacturing facilities that produced this cable have closed. There is no manufacturing facility in existence in the UK that can manufacture HVDC subsea cable or HVAC subsea cable above 36kV.

All HVDC subsea cable must therefore be imported into the UK with the principal factories being located in Norway (Nexans), Sweden (ABB), Italy (Prysmian), Japan (JPower, Viscas, Exsym and a joint venture between Nexans and Viscas) and a recently opened plant in South Korea (LS Cable).

All of the European plants are capable of manufacturing MI type cable as are two further plants, one in Japan and one in South Korea.

Solid dielectric HVDC subsea cables are manufactured in Sweden, France, Italy and Japan. The French factory is only capable of manufacturing short length land cable that must be jointed together every 1–2km.

In China there are a significant number of new land HVDC connections using overhead lines. Overhead DC lines have not been considered in this report as they are outside of the project scope.

Relatively short lengths of DC cable are used to cross water barriers, such as the channel between France and England, and to link to AC systems that are not synchronised (i.e. where the voltages of the two systems do not peak at the same instant or are not of the same frequency). The power systems across England, Wales and Scotland are all synchronised but the power system in Northern Ireland is not. The subsea connection between Scotland and Northern Ireland (the Moyle interconnector) is an HVDC connection using MI cable. The Moyle interconnector is a 2 × 250MW double monopole connection operating at 250kV DC. Monopole connections have not been considered for costing in this report as they are generally used for lower power DC connections than are considered in this report. The concentric monopole cables installed have also proven to be problematic for the owners of the Moyle interconnector.⁵² A fault from the return conductor to earth on 26 June 2011 was announced⁵³ with an estimated return to service in 3–6 months. However, the latest date for a repair is mid January⁵⁴ with a repair to one of the two poles.

One current project is a land DC connection between France and Spain. This project is 65km, 2 × 1000MW, 320kV link using solid dielectric cable, and the cable materials and installation will be supplied by Prysmian Cables at a contract value in excess of €90m⁵⁵ (this price is believed to be for cable and joint supply, jointing and installation supervision only, with the civil works – including tunnel sections – completed by others). HVDC land cable installation has not been considered by this study. Using the data from this study 65km of bipole capable of carrying 2 × 1000MW loads would have been estimated to cost around £90m (€105m). This is not a rigorous comparison because the exact extent of the Prysmian contract is not disclosed, and the land and subsea cables differ in build. Subsea installation is quite different from land cable laying and only the basic costs of installation and material have been included. However, that said, and as far as it is possible from the data available the two figures are not wildly dissimilar.

⁵² Mutual Energy Press release 26 August 2011, <http://tinyurl.com/76bqhyg>

⁵³ Mutual Energy press release 7 July 2011, <http://tinyurl.com/835f7nn>

⁵⁴ Mutual Energy Press Release 16 December 2011, <http://tinyurl.com/7fwm29t>

⁵⁵ Prysmian Press Release, <http://tinyurl.com/7j8p3bb>

Figure 55 – Cable laying vessel shore landing installation



(Courtesy of Nexans)

Adverse weather and sea conditions can considerably affect the cable installation process and escalate costs. A large fleet of vessels can be held in abeyance, waiting for favourable weather conditions. Unacceptable movement of the cable-laying vessel can cause the tension of the cable to increase beyond its working limits. This also places additional strain on the cable caterpillar drives or cable securing equipment which, if it breaks loose, can endanger the crew. If bad weather breaks during the cable-laying operation it may be necessary to cut the cable, seal it and drop it to the sea floor before heading for port. Following this action, and when the conditions improve, it will be necessary to install a joint on the cable which is assembled on the ship and laid overboard, again incurring additional cost.

It is important therefore that cost elements for vessel mobilisation, demobilisation, bad weather and sizeable contingencies are included in the budgetary cost estimates for installation.

It is not unusual for a contract to specify that a burial depth will be a target depth or attempted with reasonable endeavours. Where seabed conditions are not suitable for burial or at crossing points over other services, then alternative protection such as concrete matressing and split ducting, rock placement or cement bag placement may be used to provide alternative means of mechanical protection. This protection is placed over the cable trench to an agreed thickness to restrict unwarranted access. Care must be taken during such placement to ensure that the cables are not damaged. They must be subsequently surveyed to confirm the protection is adequate. If the cable is not immediately buried or

protected then guard boats may be employed to protect the cables from third parties dropping anchors or trawling over the cables.

Figure 56 – Concrete mattress (on board ship, prior to deployment)



(Courtesy of Cable Consulting International)

The location where the power cable arrives on land is known as the shore landing. The requirements and the cost of shore landings can vary considerably. Shallow water may mean that the cable-laying vessel which can be used to lay the majority of the cable is unable to get sufficiently close to the shoreline for the cable to be placed ashore. It may be necessary to use a separate vessel, normally a barge, with a shallow draft, to lay a length of cable from the shore landing out to deeper water. Other landings may require the safe penetration of sea defences such as sea walls. Sea walls can usually be traversed using directional drilling, although an increase in the cable's conductor size to cope with the derating of the cables may be required.

For the purposes of costing the subsea cable it has been assumed that the cable terminations are reasonably near to the coast at both landings and therefore only a directional drill and a termination compound has been allowed for. HVDC cable installation on land has not been costed.

DC subsea technology is used either for long-distance transmission. Over long distances the advantage of DC transmission over AC transmission is the much lower transmission losses. The disadvantage of DC transmission is that the networks of Europe, and the supply to Europe's industry and households, all use AC transmission and that the conversion equipment required to convert AC to DC and back again is very expensive. However, AC

networks across Europe are not identical and operate at different voltages, frequencies⁵⁶ and synchronisations.⁵⁷

G-4 List of costing sources

A list of cost sources and the method of arriving at the costs is explained in case study 5, Hinkley to Seabank, where the costs obtained were used to compile the 75km subsea connection.

G-5 Cost make-up

This section identifies the key components that go to make up the cost of a new subsea cable system.

In order to reduce the cost headings to a manageable number for the purposes of illustration and to allow supplier confidentiality to be maintained, particularly with regard to materials and installation, the following cost headers have been employed.

| | |
|---|---|
| DC subsea cable | |
| Cable studies and assessments | This cost covers the pre-build assessments of the landing sites. |
| Cable landing costs | This includes the cost of coming ashore and above the high tide mark and crossing the sea defences and terminating the cable. It does not allow for any land DC cable continuance. |
| Cable mobilisation and demobilisation costs | These costs include mobilising and fitting out the marine vessels and the cost of crews. |
| Total fixed build costs | A |
| Cable contractor project management | This is the cost of the cable and cable installation management of the project. |
| Cable studies and assessments | Assessment of the subsea cable route including desktop studies, utility surveys, sonar scans etc. These works are performed after the letting of the build contract. |
| Cable materials and installation | This cost is the main cost of the cable works, and includes the cost of materials, manufacture and installation, including the joints, jointing, cable laying and burial at 1m depth below the sea bed using 50% ploughing and 50% jetting. |
| Bad weather allowance | This is an allowance for idle time, waiting on bad weather. It is not unusual for this element to be neglected or inadequately provisioned in the costs and programme. The term “bad weather” suggests that this is something abnormal. However, bad weather in reality is a natural event that will occur, not infrequently, around the shores |



⁵⁶ Frequency refers to voltage cycles per second on the AC system. In the UK, the supply frequency (also called the mains frequency) is 50Hz; 1Hz (pronounced ‘hertz’) is the same as one cycle per second.

⁵⁷ Synchronisation refers to the synchronisation of the voltage peaks on generators connected to a common AC network. When two or more generators are connected on the same AC system the voltage generation must be synchronised, with both generators producing maximum and minimum voltage peaks at the same instant and with the same frequency.

| | |
|--|---|
| | of the UK, and cost provisions should be made. |
| Marine insurance | The laying of cables on the sea floor is an activity from which all risks cannot be eliminated. The values used for the marine insurance are based on 3% of the costs of the marine cabling element of the works. |
| Cable subsea cable crossings | This cost allows for the crossing of the bipole cables above existing services and the protection of the HVDC cables and, if necessary, the service which has been crossed. The number of crossing allowances depends on the length of the connection. |
| Cable owner's project support services | This includes the development, design, tendering and pre-build surveys performed by the owner and their project development team. This will include the surveys, stakeholder agreements and consultations, the acquisition of legal agreements and permits. It also includes the supervision of the project to completion. |
| Cable system build contingency | This includes a provision for items that have been omitted, neglected or which, in order to cost, would require an unnecessary level of detail for this report. It also includes an element of price uncertainty or fluctuation as the material and installation prices selected from those given are, so far as is reasonable, the lowest. |
| Total variable build costs | B |
| Total build costs | C = A + B |
| Cost of power losses | Costs associated with having generating plant available to generate the energy losses (described further in Appendix D). |
| Cost of energy losses | Costs associated with the fuel burned in the power station to supply the conductor losses (described further in Appendix D). |
| Operation and maintenance | This is the cost of maintaining the subsea cables. |
| Total variable operating costs | D |
| Lifetime cost | E = C + D |

G-6 Cost sensitivities

This section identifies the key factors to which the estimated prices are sensitive, and provides typical ranges within which the costs could vary, all else being equal:

This section identifies the key components which go to make up the cost of a new underground subsea cable in UK waters.

System planning and client outline design

HVDC connections are expensive undertakings and thus the client must initially identify the need case. This often involves an early “optioneering” exercise where different technologies and arrangements are investigated to find what the owner considers to be the most suitable transmission technology and cost.

There are relatively few transmission class HVDC connections to, from or within the UK. The oldest HVDC transmission connection, installed in the 1980s, is that beneath the English

Channel connecting England to France. A connection between Scotland and Northern Ireland (the Moyle interconnector) and one between the Netherlands and the UK (BritNed) have recently been connected. A further interconnector, the East-West interconnector, to connect Wales and Ireland, and construction is underway now. These are all point-to-point connections between different AC networks.

Currently planned/in-progress are the so-called “bootstrap” connections down the north-east and north-west coasts of Scotland and England. The 2000MW HVDC Western Interconnector⁵⁸ is planned to connect Hunterston power station in Scotland to Connaught Quay in Deeside in England. The total HVDC cable connection length will be around 410km (50km of this total is on land). This is due for completion in 2015. The Eastern 2000MW HVDC Interconnector between Peterhead and Hawthorne Pit (Durham) is planned⁵⁹ but not required until 2018.

The planning and implementation for such interconnectors is a process involving many years of planning and agreements.

Repair of one serious but credible incident

The time cost of a serious repair to a subsea cable is usually measured in months rather than weeks.

Following a fault, the owner of the link is faced with the problem of identifying the location of the fault. Nevertheless an inspection along the sea surface route, particularly at depths where anchors may be deployed, may identify an anchored vessel. It has been known for vessels to haul up cables on their anchors, this being the first knowledge on the vessel that a cable has been caught. Even if the cable has been damaged by a third party, the person/vessel responsible is likely to have cleared from the location.

A UK transmission operator is unlikely to have their own staff capable of repairing a subsea cable, and thus it will be necessary to engage a cable investigation and repair team. If insurers are involved, they will wish to have a representative, and if the cable is under warranty, the cable manufacturers and the installation company are also likely to have an interest, in case any latent defect of their activities was the cause of, or contributed to, the fault.

The cable fault must then be located, and this is usually performed by electric or optical pulse (if the cable contains a fibre optic) from either end of the cable. Having obtained an approximate location for the fault, the type of vessel and equipment required to repair the cable(s) may be assessed. Much will depend on the depth of water, the prospects of repair being possible in a weather window, the availability of suitable vessels, marine crew, cable handling and repair personnel, and remotely operated vehicles/divers. The repair vessels are generally of a multi-purpose nature and thus will need to be fitted out with cable handling equipment planned and located at the correct positions on the vessel's deck. In shallow water a flat-top barge may be needed, which will then require a vessel to move the barge into location and handle its anchors. A cable repair vessel is usually fitted with bow and stern thrusters capable of holding the vessel's position in good weather using dynamic positioning (DP). Figure 57 is a photograph of the 3083 tonne cable repair vessel, DP Reel,⁶⁰ this ship has dynamic positioning and has a draft of 4.1m.

⁵⁸ More details on the HVDC Western interconnector can be found at: <http://tinyurl.com/7mo7wny>

⁵⁹ Scottish Government, Key Policies and Drivers, 29 Dec 2012, <http://tinyurl.com/7hntm6c>

⁶⁰ Further details on this vessel is available at: <http://tinyurl.com/6rxrj32>

Figure 57 – Subsea cable repair vessel (DP Reel)



(Courtesy of Cable Consulting International)

As part of the repair strategy the owner will have been advised to order spare cable, joints and possibly terminations. The spare cable may be stored on drums on shore or placed in a designated “wet store” on the sea floor. If the repair cable is located in a wet store, the vessel must locate the wet store cable and haul a length of it off the sea floor and onto a drum and, if necessary, test it. The length of wet store cable required will not be fully understood until the cable fault location has been accurately ascertained. This is because it will be necessary to both cut back the faulted cable ends to a dry location and allow for a length of repair cable, at least twice as long as the depth at which the fault occurred; this allows the cable repair to be performed on deck and a loop of cable placed on the sea floor. The joints supplied will be of a type suitable for assembling on the vessel. Depending upon the joint design, the joint may be flexible (capable of being bent and flexed similar in performance to the cable) or rigid and non-flexible.

The repair vessel will thus need to be of sufficient size to hold the spare cable drum, broad enough for the cable to be hauled onto the deck and a joint inserted into the cable repair, and have sufficient accommodation for crew, repair team and inspectors.

Following the completion of the first joint, the cable must be tested to ensure that the section of cable from the vessel to the shore end is sound. The first joint is then paid over the vessel with part of the repair cable. The other cut end of the cable is then recovered and cut back to a dry position where the closing repair joint is installed. On completion the joint is lowered over the side and the repair loop lowered over the side on a semicircular “quadrant” to the sea floor where the cable is released. The entire length is then retested to ensure that it is sound, protected/buried as necessary and, if necessary, retested before re-entering service.

It is not possible to give a “general” cost of repair. However, an allowance of £4–6m would not be unrealistic for each incident.

G-7 Anticipated future developments

The vast majority of HVDC transmission is from one point to another on merchant connections. The use of multi-terminal or network HVDC is limited. The advantage of a multi-terminal network is in the reduced number of converter stations required. A DC current breaking device which is commercially viable has not yet been developed. Currently the only means of breaking the DC current supply is by a voltage collapse at a converter station or by cutting the supply to the converters using the AC supply (i.e. by use of AC current breakers). A commercially viable DC current breaking device is currently under development by at least one company in the UK. This device should enable DC networks to be operated effectively. If, for example a cable fails on a DC leg of a network then the entire network will fail.

HVDC CSC converter technology of 1000kV and above was the subject of a technical paper⁶¹ in 2010, enabling ever greater power transfer over longer distances. However, such transmission voltage levels require the use of OHL technology as underground cable suitable for long-length DC transmission at such voltages is not currently available: the nominal maximum voltage in use/developed is 500kV for both solid dielectric and MI insulation.

The power transfer of the cable is limited by both the maximum voltage that it can support and the maximum current that it can pass without overheating the cable insulation. Mass impregnated cable currently operates at between 50°C and 55°C, European manufactured solid dielectric cables operate up to 70°C and Japanese solid dielectric up to 90°C. There are also possibilities of using a paper/polypropylene laminate (PPLP) within MI cable, raising the maximum operating temperature of MI cables to 80°C. All of these cable types are suitable for use with CSC or VSC converters with the exception of some European solid dielectric cable, which can only be used with VSC converters.

On paper, the Japanese solid dielectric cable operating at 90°C and up to 500kV appears to offer the highest power transfer capability of any cable design. All of the manufacturers of HVDC converter equipment are based in Europe and it is the European solid dielectric cables operating at a current maximum of 300/320kV with VSC converters that have been preferred over the Japanese designs, which have seen little or no service experience to date.

⁶¹ “Technical Feasibility and Research & Development Needs for ±1000kV and above HVDC System”, Nayak N., et al., paper B4-105, CIGRÉ, Paris, 2010

Appendix H Technology – HVDC Converter Stations

H-1 An introductory note on HVDC converters and subsea cable

This appendix focuses upon the technologies and costs of HVDC converter stations. However, for any meaningful understanding of the overall costs of HVDC links to be gained, the costs of converter stations must be taken together with the costs of the HVDC connecting cables. For this reason, whilst we have split the descriptions of converters and cables into separate appendices here (they are, after all, very different technologies), we have presented the costs of HVDC converters and their HVDC cables together in the main report.

H-2 Technology description – HVDC

Electrical power transmission systems around the world typically use alternating current (AC); however, direct current (DC) is often used either where electrical connections are required over very long distances, or where long subsea crossings are required. Since the DC voltages used in such installations are very high, they are commonly termed HVDC (high voltage DC) installations.

The common use for HVDC is to provide a connection between two AC systems with different frequencies. Unequal frequencies often occur between neighbouring jurisdictions, and where an HVDC installation connects across an international boundary it is often referred to as an HVDC interconnector. In this document, however, we restrict ourselves to the more general “HVDC installation” or “HVDC link” terminology.

An HVDC installation comprises:

- a converter station, acting as a rectifier to convert AC to DC,
- one or more pairs of HVDC conductors (underground cable or overhead line) to transmit the power to its destination, and
- a second identical converter station, acting as an inverter, to convert the power back from DC to AC.

The converter stations at the two ends of the link are identical, and their controls determine whether they act as rectifier or inverter, thus making it possible for power to flow through the link in either direction.

Although HVDC transmission conductors themselves (whether underground cable or overhead line) may be of lower cost than a comparable AC transmission connection, significant extra cost will be incurred for the converter stations. At any given time in their operation, the sending end station converts AC power to DC whilst the other converts it back from DC to AC. The conversion process is performed by power electronic valves (utilising either insulated gate bipolar transistors or thyristors), as described in the following sections.

The main advantages offered by high voltage direct current (HVDC) transmission over very long distances are lower losses, construction costs typically less than the AC option, and lower capacitance effects than would be experienced in the case of AC cable transmission.

Other benefits of HVDC can include:

- capability to link asynchronous systems (AC systems with different frequencies or phasing),

- control of power flows for most AC systems,
- no technical limit on distance of transmission (for either lines or cables),
- lower transmission losses than AC for long connections,
- fast real and reactive power control,
- assistance in AC system stability, and
- minimal magnetic fields for cable transmission.

H-2.1 Types of HVDC conversion

There are two distinct HVDC technologies currently used in electricity power transmission:

- current source converter (CSC), sometimes called line commutated converter (LCC), or “classic”
- voltage source converter (VSC)

The converter valves of the more established CSC technology are based on thyristors, which rely upon the AC system for commutation. In summary, CSC converters:

- are naturally commutated converters (i.e. they use the AC system for commutation),
- absorb reactive power, and thus requires reactive compensation,
- require harmonic filtering devices,
- typically cannot be connected to weak AC systems,
- have capacities currently in service of up to 6000MW with future developments planned for 7200MW using 800kV overhead line,
- currently offer transmission capability of over ten times that of VSC, although with planned future VSC projects this figure will reduce to below four,
- require converter station footprint areas approximately 70% greater than the equivalent capacity VSC sites,
- emit losses of less than 1.5% of rated capacity for the two converter stations combined (not including the cable connection), and
- cannot use solid dielectric XLPE transmission cables, so are restricted to the mass impregnated (MI)⁶² type of cable.

The 450MW Ballycronan More CSC converter station, situated at Islandmagee (the Irish end of the Moyle interconnector between Scotland and Northern Ireland) is shown in Figure 58.

⁶² MI transmission cables, which are more costly than the equivalent capacity solid dielectric XLPE cables, are paper-and-oil insulated, and are sometimes called self-contained liquid-filled cables (SCLF)

Figure 58 – Ballycronan More 500MW CSC converter station



The VSC alternative to CSC has been developed relatively recently, and is based upon pulse width modulation and multi-level switching converter technology. In summary, VSC converters:

- use power electronic turn-on/turn-off switches (gate turn-off thyristors or insulated gate bipolar transistors) rather than thyristors,
- have grown in popularity over the past 15 years from beginning with 80MW links to 400MW (presently in service), and with links up to 1000MW currently being built,
- can operate between 0% and 100% of rated capacity,
- have near-future potential for capacities well above 1000MW,
- do not need to rely on the AC system to perform its conversion process (self commutating),
- require less harmonic filtering than the equivalent CSC,

- can be connected to weak AC systems,
- can provide ancillary services such as “black start” (ability to start up an AC grid network without embedded generation),
- can control active and reactive power independently,
- can use cheaper/lighter XLPE cables (XLPE use within HVDC is an advancing technology, and is continuing to be developed for higher voltages),
- require converter station footprint areas approximately 40% smaller than the equivalent capacity CSC sites,
- are capable of reversal of power without significant delay,
- emit losses of around 2% of rated capacity for the two converter stations combined (not including the cable connection), and
- require a shorter build programme than equivalent rated CSCs.

H-2.2 Converter station components

The following main items of equipment (which are common to CSC and VSC technologies) make up the converter stations for HVDC transmission:

- DC terminal area (comprising cable termination, HVDC disconnectors and circuit breakers, instrument transducers and HVDC filters)
- converter valves
- reactors
- converter transformer
- AC filters/capacitors
- AC switchyard/substation
- control room
- ancillaries (cooling equipment, control, protection, communications, etc.)

The DC and valve areas are typically housed in buildings, with converter transformers and AC switchyard located out of doors. A smaller site footprint can be achieved using compact designs for both the AC and DC equipment, but this more costly option is not included within these cost estimates.

H-2.3 HVDC links

HVDC converter stations can be designed with either a monopole or a bipole configuration. The bipolar design, with high voltage DC conductors at both plus and minus DC voltages, is prevalent. Monopoles, with one high voltage conductor and the other conductor being at earth potential, are less common. (Earlier monopole links often used earth or sea return conductors to reduce the cost, but present practice is to install a metallic return, mainly for environmental reasons.)

This cost study is based upon the bipole converter station configuration. However, in the event of a fault, some bipole stations may be reconfigured to adopt a monopole operation

with 50% transmission capacity, thus minimising the impact of outages due to equipment failure.

H-3 Civil works

As shown in Figure 59, converter station components there are five main areas of a typical converter station. Subject to the actual HVDC technology, the DC hall, valve hall and control room are large buildings with the valve hall approaching 24m in height.

Figure 59 – Typical converter station layout and size

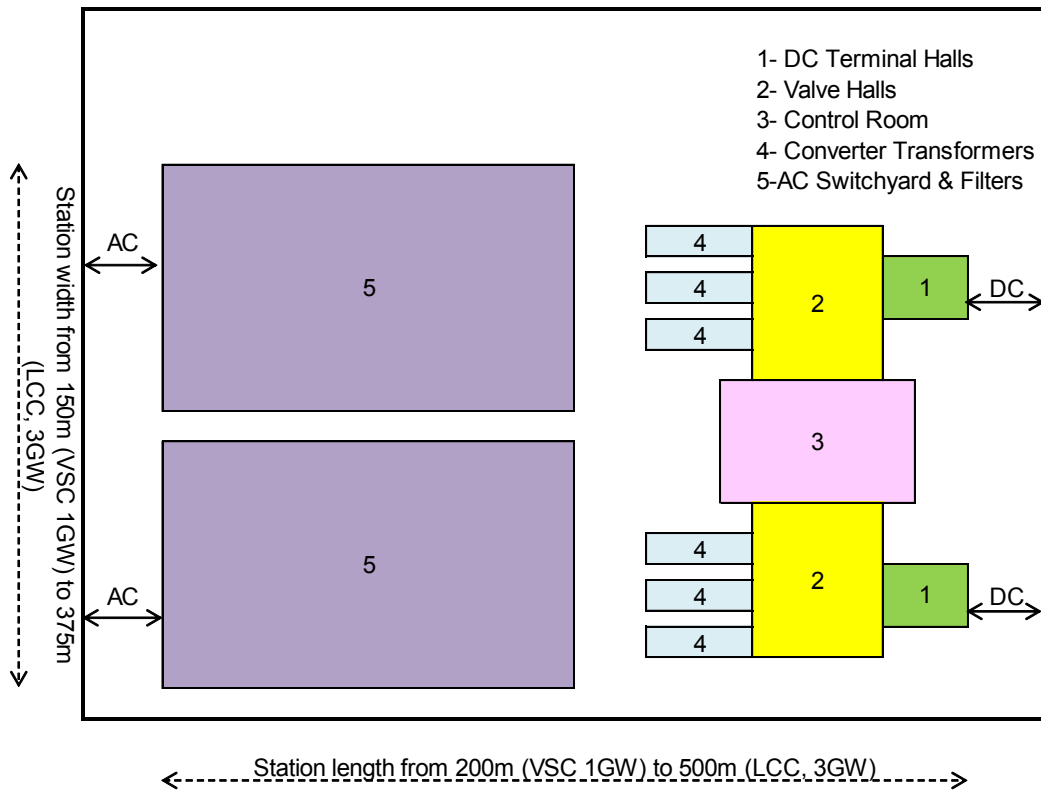

Converter transformers are heavy items of equipment (often over 100 tonnes each) requiring appropriate foundations and oil bund, interception and storage areas.

The converter AC switchyard is comparable in character to existing substations within the AC transmission system. However, the land area of this part of the converter station varies significantly, depending on the HVDC technology employed and the transfer capacity of the HVDC link. The limits of this variation are indicated in Figure 59.

Depending on the geology of the site there may be extra cost for piling and removal of existing ground material to meet the required building and equipment loadings and environmental requirements. This extra cost is not included within the cost estimate but its impact is covered by the sensitivity analysis.

The following diagram, Figure 59, identifies the main elements of an HVDC converter station, and indicates the range of land area needed. As displayed within Figure 59, the land area of the station is highly variable. The main influence on the area is the design of the AC switchyard and filters, which is dependent upon the AC busbar arrangement and number of reactive compensators/AC filters required.

HVDC converters

H-4 Application of the technology

At present, HVDC links are usually arranged as point-to-point connections – that is, they have only two connection points. Multiple connection points have not, in practice, been easy to achieve with the classic CSC technology, although this is set to change with developments in the newer VSC designs. For this study, however, we limit the cost estimates to those for point-to-point (two-ended) links.

HVDC links can transmit power over significant distances (for example, the Sardinia to Italy SAPEI subsea cable interconnector is 420km long) and typically the links will:

- provide power transmission interconnectors between countries,
- enable long subsea connections to be made, or
- connect together AC systems that are not synchronised.

For power transmission applications other than these three, and particularly over relatively short distances, AC rather than HVDC transmission links are normally more economic due to the high cost of the AC/DC converter stations of the latter.

Where the extra cost of a HVDC link can be justified, the choice between CSC or VSC technologies would require technical and economic studies to determine the appropriate solution. Amongst other things, these studies would normally take into account:

- the length of the transmission route, and its required capacity,
- whether ancillary services (which can be provided by VSC) are also required,
- the “strength” of the AC systems being connected together, and
- the additional costs associated with any environmental impact mitigation.

Regarding the siting of converter stations, important criteria to consider would include:

- the proximity to the existing AC network and the need for any new AC connections,
- access of the AC and DC connections to the converter station site,
- planning approval, and impact upon the local community, and
- any impact on the environment.

H-5 Cost make-up

To date, the number of HVDC projects commissioned in any one year, around the world, is rarely more than four or five. Almost every HVDC link constructed is unique, needing to meet the particular requirements of the transmission system and developer in the context of the HVDC equipment supply market prevailing at that time. This means that duplication of projects does not often occur, and that the statistics associated with HVDC converter station costs are rather sparse.

Given the above, this cost report has not attempted to use individual equipment component costs to build up an overall station cost. Rather, it has gathered data from manufacturers and owners of recent projects, and has used budget estimates for future proposed installations where these have been made available.

These costs and cost estimates have then been averaged to arrive at “primary” cost estimates for converter stations based on the two technologies, and covering a range of transmission capacities.

Whilst developing average costs for HVDC converter station installations, we recognised that these costs can vary widely, depending upon the electrical and environmental factors of the specific application. So, in addition to the above study, the factors to which HVDC converter costs are most sensitive have been identified, and the sensitivities quantified so far as possible.

The CIGRÉ⁶³ Brochure 388 (Aug 2009), an authoritative study on HVDC installations around the world, includes cost division information (Table 5.4, p. 104), allowing us to estimate the costs of the main components of the converter. This information was then used in our cost sensitivity assessment.

The basic converter station costs presented in the main part of this report assume a bipolar configuration with, in the case of VSC, two parallel-connected VSCs per pole to meet the 2GW and 3GW capacities. Costs also assume the purchase of typical strategic spares – that is, those items of equipment without which the converter cannot function but which have a long lead-time in the event of replacement being required following equipment failure. This spares allocation includes converter transformers, reactors, valves, capacitors and specialist tools for maintenance, as appropriate for each technology.

The value of ancillary services (e.g. black start) that could be provided by a VSC converter station has not been considered within this report – neither has the cost of providing such services.

Our HVDC costs are made up of two sections: fixed build costs, and variable operating costs. Unlike the other technologies covered by this report, there are no variable build costs since the converter stations only occur at the ends of the connection, and are not significantly affected by the length of the connection itself.

| HVDC converter stations | |
|--|---|
| Converter project launch + management | Owner costs – facilitation costs that are required to allow the project to proceed – see fuller description under underground cable cost make-up. Note that in this case, legal, technical, environmental and insurance advice would be required for every aspect, including subsea service crossing agreements. In addition, planners, fisheries and military authorities would need to be consulted. This figure includes reasonable provision for converter land purchase. |
| Converter engineer, procure, construct (EPC) contract cost (GBP costs) | The converters will be designed and built as a turnkey contract. This cost element relates to all the turnkey costs accounted for in GBP |

⁶³ CIGRÉ – the International Council on Large Electric Systems

| | |
|---|---|
| Converter EPC contract cost (EUR costs) | Some of the turnkey contract may have exposure to the euro exchange rate – this cost element relates to all the turnkey costs accounted for in EUR. |
| Converter build contingency | 10% allowance for unforeseen costs, as described for underground cable make-up. |
| Total fixed build costs | A |
| Total build costs | C = A |
| Cost of power losses | Costs associated with having generating plant available to generate the energy losses (described further in Appendix D). |
| Cost of energy losses | Costs associated with the fuel burned in the power station to supply the converter station losses (described further in Appendix D). |
| Operation & maintenance | This is the cost of maintaining the converter stations. |
| Converter refurbishment | Major mid-life refurbishment of electronics. |
| Total variable operating costs | D |
| Lifetime cost | E = C + D |

Client set-up and costs during construction

The client set-up costs include all costs incurred during the front-end work in developing the project up to award of a design/construction contract. They include internal costs, conceptual design, environmental impact assessment (EIA), consenting process, site preparation, surveys, land purchase, planning and public consultation and cost of finance. In this report the set-up cost has been estimated as 3% of the converter station build cost.

During the converter station construction by the main EPC Contractor there would be client costs for activities such as hiring consultants, various other contractors/surveyors/inspectors, insurance and legal fees, connection of local amenities and energy costs during commissioning tests, etc. This cost can be significant and has been estimated as 9% of the converter station build.

The client costs described above are based on the owner-experience of recent HVDC installations.

Converter station costs

Our costs are for the design, construction and commissioning of two converter stations under an engineer, procure and construct (EPC) contract. The maximum DC transmission voltages are assumed to be ±320kV and ±400kV for the VSC and CSC technologies respectively. A single VSC bipole cannot currently achieve a 2GW transfer, so we assume that two parallel connected VSCs would be required for 2GW or 3GW transfer capacity.

Lifetime costs

The converter lifetime costs cover annual operation and maintenance cost (typically a two-week annual outage is scheduled for HVDC converter stations), consumable spares used during annual maintenance and electrical losses.

Our operation and maintenance cost estimates are 2% of the converter station capital cost, this figure having been obtained from a recent HVDC project (identity confidential).

CSC electrical losses as stated in the CIGRÉ Brochure 388 (Aug 2009), as 1.5% of the rated transfer capacity for each station, are used within the cost study.

VSC losses have, until recently, been stated as up to 3.6% of the rated transfer capacity, but with research and improving VSC design the losses are now being stated as 2% for the two converter stations together.

It is possible that the costs of a serious but credible equipment failure, such as damage to a converter transformer, be incurred during the life of the plant. Whilst we have included strategic spares in the capital cost, the labour required to replace a faulted converter transformer with the spare, and then repair the faulted transformer itself, is difficult to estimate, but it is expected that any repair cost will be a very minor cost in comparison to the 40-year lifetime costs.

The cost impact of plant refurbishment, which can be significant, has been considered within the lifetime costs. It is commonly accepted that the control element of the converter station will be refurbished, and this has been included within the cost study after 20 years. Refurbishment of the valves may also be implemented if the converter's availability performance warrants it. However, this would represent a much larger cost than the control refurbishment, so it is included within our cost sensitivity analysis.

H-6 Cost sensitivities

The primary cost estimates discussed in the preceding section are sensitive to a number of factors, and we list here some key factors that could significantly modify the cost of a specific application away from the primary cost estimates:

- market conditions for converters
- sterling/euro exchange rate
- route length
- converter refurbishment costs
- average circuit loading
- materials prices

H-7 Cost comparison – reliance on cable type

As explained at the start of this Appendix, HVDC converter stations represent just part of the cost of an HVDC link. The connection between the two stations is equally important, and in this report we also consider the costs of subsea HVDC cables. HVDC undersea cables are the subject of a separate section of this report – Appendix G – and the following comments are intended to outline the HVDC context within which the cable costs should be interpreted.

Most importantly, any cost comparison between CSC and VSC converter stations needs to take into account the technical restrictions on the use of a particular type of cable. XLPE cable technology has developed to the extent that this type of cable may be used with the highest voltage VSC stations. This is possible because the VSC HVDC technology does not require the cables to change polarity as the direction of power flow is changed.

However, this is not the case with the classic CSC HVDC technology, where change in direction of power flow requires the connecting cables to swap polarity. The current state of XLPE cable development cannot accommodate this reversal in polarity, so CSC stations have to be connected using the more expensive MI cable type.

We show in the main report that VSC converters are generally more costly per MW transfer capacity than the CSC equivalent. However, when costing an HVDC link it is important to take account of the costs associated with both the converters and the cable between them. By doing this, it becomes evident that the technical limitation imposed by XLPE cable, in conjunction with the differing costs of the two types of converter, results in short HVDC links being more economic with a CSC design, and long HVDC links being more economic with a VSC design. The cross-over point – the length of a link at which the two technologies cost the same, will depend upon all the sensitivity factors described in the main report for subsea cable and HVDC converters.

H-8 Costing sources and confidence levels

This section outlines the sources of each of the above-described costing and cost sensitivity items. It describes the levels of confidence which may be placed in the figures which contribute to the costing estimates for this technology.

The requests for cost data from the industry were in two forms, one being a request from asset owners, the other from manufacturers. The helpful replies received from the manufacturers were either a budget estimate, or published costs of specific recent projects. Within the CSC and VSC 1GW, 2GW and 3GW categories, each of the respective manufacturer costs were averaged to provide the figures used in this report.

Within Europe the main manufacturers of HVDC converter stations are ABB, Alstom and Siemens. All three have provided costing information for the cost study. There are other manufacturers of HVDC systems such as Toshiba and Hitachi but their work is mainly restricted to Japan.

Very few responses to data requests were received from HVDC link owners. However, one helpful reply related to a recently installed HVDC link that has enabled the report to include “client set-up costs”.

H-9 Anticipated future developments

We anticipate that, over the next 10–15 years, continuing developments in VSC technology will see VSC transmission links being capable of transfers in excess of 2000MW. These developments, along with those in XLPE cables, may render the cost of VSC links comparable with that of equivalent capacity CSC links over the same period.

Reduction of VSC power losses will continue as the technology develops. However, whilst we anticipate VSC technology to be capable of greater power transfers in the future, we believe that cost reductions for VSC projects have already been taken through the benefit of using XLPE instead of MI cable, and future cost reductions will be mainly confined to reductions in operational costs as losses decrease.

The number of HVDC installations currently in service is just over 90 in the world, some having been in operation for over 45 years (ref. Index of Operating Schemes, CIGRÉ B4 Working Group). It is noted that the rate of completion of new installations has recently increased, with 43 new HVDC links completed in the past 10 years. This significant increase of HVDC installations is forecast to continue and within the next four years approximately 16 new projects are expected to complete. This increase of HVDC projects reflects a number of new drivers in the industry: from countries expanding their grid systems (e.g. India and China), to the interconnection of world energy markets and connections to large-scale offshore wind farms.

HVDC multi-terminal technology (the establishment of an HVDC circuit to which several converter stations are connected at various points along the connection, rather than just two, one at each end) has not been discussed within this report because it is not yet a mature technology at transmission voltages and power transfer levels. There are a few examples of HVDC multi-terminals around the world, though none in the UK, and none demonstrating reliably the advantages which the technology theoretically promises. However, with the advancement of VSC technology, in conjunction with the rate of adoption of HVDC links described above, we consider that multi-terminal HVDC systems will become a practical reality for grid systems within the medium term.

Appendix I Technology – Gas Insulated Lines

I-1 Technology description

Gas insulated line (GIL) transmits bulk electricity supplies at high voltage and, in some applications, represents a viable alternative to overhead lines or underground cables.

Each phase of a GIL consists of an aluminium conductor running down the centre of an outer aluminium tube. Epoxy cast resin insulators centre the high voltage conductor within the outer enclosure, which is itself earthed. The enclosure is then filled with a mixture of nitrogen and sulphur hexafluoride (SF₆) gases to complete the electrical insulation. Three such tubes are required to make up each three-phase transmission circuit.

The aluminium tubes provide a secure mechanical containment for the conductors and insulating gasses. The centrally mounted conductor is made of low resistivity aluminium alloy to minimise losses and provide high mechanical strength. An example of the equipment offered by the manufacturer Siemens is shown in Figure 60.

Figure 60 – Short section of gas insulated line, by Siemens

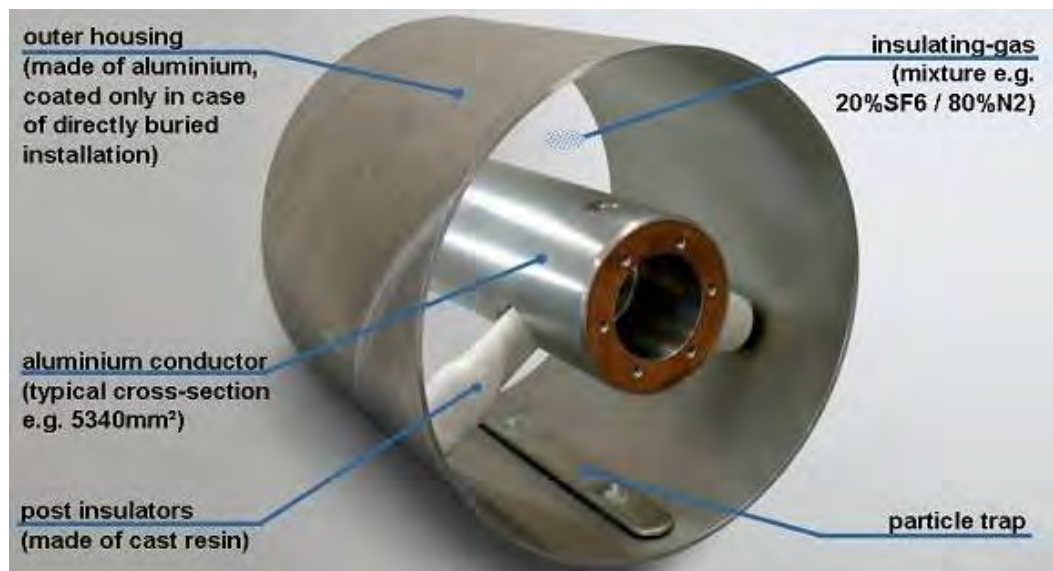

I-2 Installation options

GIL may be mounted at ground level, on substantial metal supports above ground, buried below ground or contained within a tunnel. It may be delivered in one of two forms. In the first form, it would arrive in assembled sections – short enough to be delivered by road – and fixed together on site. As an alternative, the constituent materials could be delivered to site, then fabrication and assembly would take place there in a temporary clean conditions environment.

For direct buried installations, each GIL section would then be lowered into a trench and connected to the sections already in place. After connection of the central conductors, the outer pipes would be welded using an automated welding station, and external protection would then be applied. Figure 61 shows the process of weld edge preparation prior to connection of two outer tubes.

Figure 61 – GIL weld edge preparation prior to connection



Once a section of GIL is ready for connection, it is moved to its operational position. Figure 62 shows a section of GIL being lifted into place. In this example, the GIL is to be installed above ground, on steel supports. The outer casing has been fabricated from aluminium strip with a helical weld. The end of the tube has been capped to maintain cleanliness within.

Whichever delivery method is chosen, the GIL tubes have a minimum bend radius of around 400m. For deviations sharper than this, the trench or tunnel would need to accommodate special flexible connectors and “knuckle joints” to allow the GIL to change direction.

For high voltage testing of the installation, “partition modules” would be installed every 1000–1200m. The partitions each contain a removable conductor piece and a flange to allow connection of a high voltage test bushing.

Figure 62 – GIL segment being lifted into position



There is minimal use of GIL in the UK at present, although National Grid now owns a number of examples of the similar gas-insulated busbar technology. Elsewhere in the world GIL is currently normally installed below ground, either direct buried with an anti-corrosion protective layer, or in a tunnel. One of the main benefits for below-ground installation is safety, since this approach prevents public access to the equipment. Shorter lengths of GIL/GIB are sometimes installed above ground, but normally within the confines of a power station or substation where personnel access to the equipment can be controlled.

GIL terminations at the substation have been considered within the overall costs of the technology. These items can be described as fixed or non-variable costs associated with the technology due to the fact that the costs would not change with respect to the different circuit lengths being considered. For 400kV substations within the UK, we have considered two different termination arrangements: termination for substations of air insulated switchgear (AIS) design and of gas insulated switchgear (GIS) design.

For a GIS substation interface, typical equipment to consider would include the GIL-GIS interface module (dependent on GIS type at substation), any additional angular and tube modules installed above ground, and the required steel support structures. For an AIS substation interface, typical equipment to consider would include SF₆/air outdoor bushings, bushing interface modules, angular modules for change in direction and the steel structures for supporting the bushing.

Worldwide, GIL is not a commonly used technology but for some applications it does offer distinct technical benefits over the alternatives:

- Overhead connections using GIL can be a useful alternative to UGC, especially where the existing services below ground make UGC routing difficult to achieve.
- Resistive losses for GIL are typically considerably lower than for UGC or OHL.
- Phase-to-earth capacitance of GIL is also much lower than that of UGC, so phase angle compensation is usually not required.
- EMFs from GIL are generally lower than those from OHL and UGC.
- Should a flashover occur within a GIL tube, the insulating gas mix allows the insulation performance to self-heal immediately after breakdown.

There are not many applications of GIL around the world's transmission networks, so operation performance is difficult to measure objectively. We have seen no failure statistics or insulation gas mix leakage statistics for 400kV GIL; however, anecdotally the technology is considered safe and reliable. The following table provides some examples of GIL installations around the world: we note that only one of these installations has been buried underground.

Table 11 – Siemens GIL installations at 400kV

| Country | Rated voltage (kV) | Rated current (A) | Total circuit length (km) | No. of circuits | Position | Date installed |
|--------------|--------------------|----------------------|---------------------------|-----------------|------------------------------|----------------|
| Germany | 420 | 2500 | 1.3 | 2 | Tunnel with vertical section | 1975 |
| Namibia | 362 | 800 | 0.27 | 2 | Vertical and welded | 1976 |
| Iran | 420 | 1600 | 1.23 | 2 | Tunnel | — |
| Libya | 245 | 800 | 0.27 | 4 | Outdoor | 1980 |
| Saudi Arabia | 420 | 2500 | 0.1 | 2 | Outdoor | 1981 |
| Norway | 300 | 3150 | 0.04 | 1 | Outdoor | 1981 |
| Germany | 420 | 1000 | 0.27 | 1 | Tunnel | 1982 |
| Saudi Arabia | 420 | 2500 | 0.17 | Several | Outdoor with sunshield | 1984 |
| Saudi Arabia | 420 | 2500 | 0.33 | 2 | Outdoor with sunshield | 1984 |
| Germany | 420 | 1000 | 0.27 | 1 | Tunnel | 1985 |
| Canada | 550 | 4000 6300 8000 | 0.4 0.14 0.53 | Several | Outdoor | 1985–1987 |
| Saudi Arabia | 420 | 2500 | 0.17 | 2 | Outdoor | 1988 |
| Germany | 420 | 1000 | 0.27 | 1 | Tunnel | 1990 |
| Indonesia | 150 | 3850 | 0.77 | 2 | Outdoor | 1992 |
| Singapore | 245 | 2000 | 0.07 | 2 | Basement | 1992 |
| Egypt | 245 | 1250 | 0.22 | 2 | Outdoor | 1993 |
| Switzerland | 300 | 2000 | 0.85 | 2 | Tunnel | 2001 |
| Thailand | 550 | 4000 | 1.17 | Several | Outdoor | 2002 |

| Country | Rated voltage (kV) | Rated current (A) | Total circuit length (km) | No. of circuits | Position | Date installed |
|--------------|--------------------|-------------------|---------------------------|-----------------|--------------------|----------------|
| Egypt | 245 | 3150 | 0.6 | 2 | Outdoor | 2004 |
| UK | 420 | 4000 | 0.25 | 2 | Outdoor and tunnel | 2004 |
| India | 420 | 2000 | 1.5 | 2 | Tunnel | 2006 |
| Dubai | 420 | 2500 | 1.3 | Several | Outdoor | 2007 |
| Germany | 420 | 2750 | 1.8 | 2 | Buried | 2009 |
| Austria | 420 | 1000 | 0.2 | 1 | Tunnel | 2010 |
| Dubai | 420 | 2500 | 0.3 | Several | Outdoor | 2010 |
| Dubai | 420 | 2500 | 0.2 | Several | Outdoor | 2010 |
| UK | 420 | 4000 | 0.3 | Several | Outdoor | 2010 |
| Saudi Arabia | 380 | 3150 | 7 | Several | Outdoor | 2010 |
| China | 550 | 4000 | 1.1 | 3 | Vertical shaft | 2011 |

I-3 Civil works

Below are examples of typical arrangements for direct buried and tunnel GIL installations. There are two standard arrangements for tunnel installation, dependent on the terrain. For rural or areas with medium population density, surface tunnels could be utilised. Within densely populated urban areas then a “drilled tunnel” may be considered as the optimum solution. Note that the dimensions shown are based on typical 400kV GIL double circuit arrangements.

Figure 63 – Example of direct-buried GIL double circuit

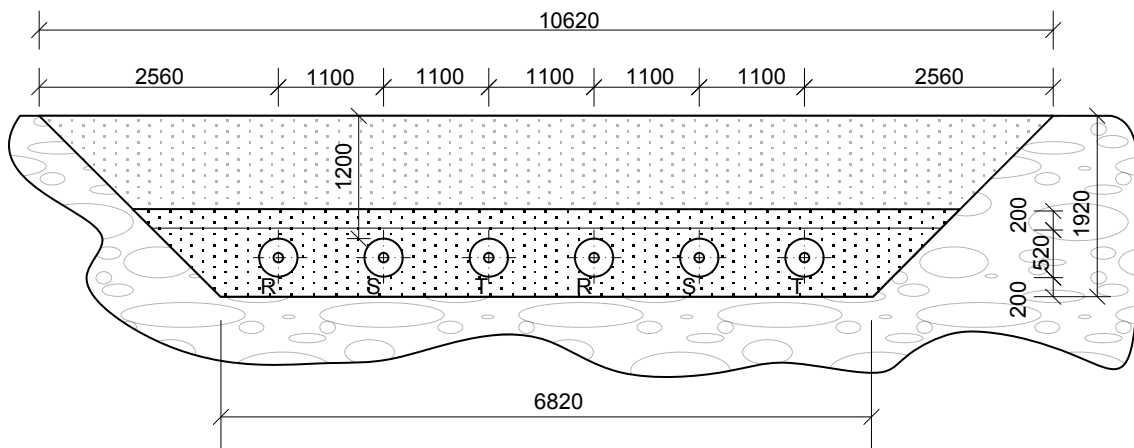

Gas Insulated Line

Figure 64 – Example of GIL double circuit in vertical-sided (surface) tunnel

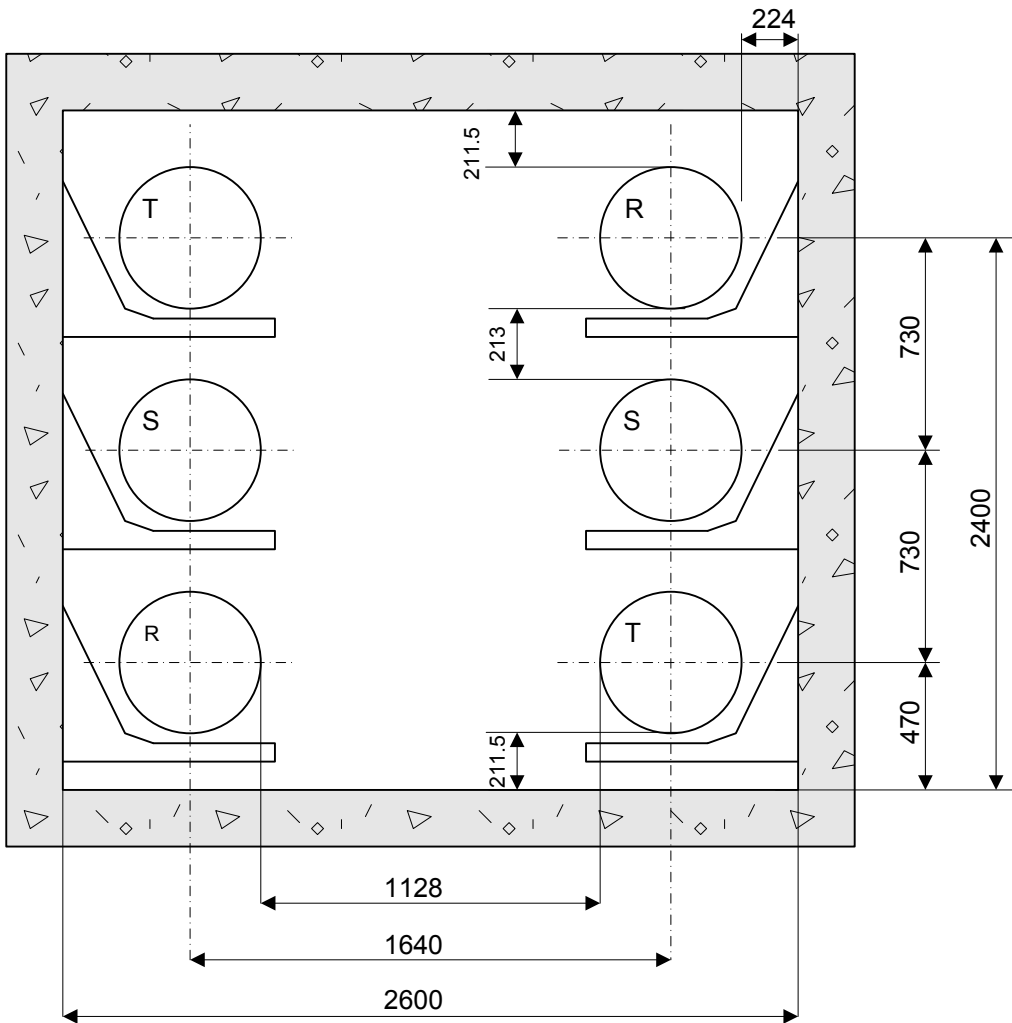
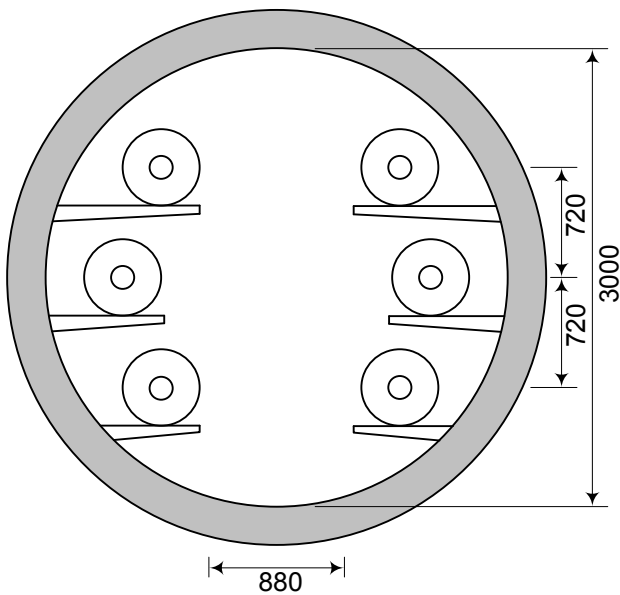

Figure 65 – Example of GIL double circuit in typical bored tunnel



I-4 Application of the technology

Amongst the applications which may benefit from the use of GIL are:

Hydro power stations – In the design of hydroelectric power stations it is often required for power to be transmitted over large vertical distances. GIL can connect generators and step-up transformers located on a low level to transmission lines at higher elevations.

Renewable energy applications – Offshore wind farms typically generate large amounts of power in remote locations. As subsea applications of GIL develop, the technology may become a suitable low-loss alternative to cable for the transmission of bulk power to the main transmission network.

Environmentally sensitive areas – In areas of natural beauty direct buried or tunnel-installed GIL may help to control the visual impact of a transmission installation.

Urban environments with minimal space – Where the use of OHL is restricted due to lack of space, GIL may provide equivalent transmission capacity utilising less space per circuit.

Line crossings – In locations congested with transmission circuits, GIL can offer a compact crossing alternative to UGC.

I-5 GIL cost make-up

The following list identifies the key components which go to make up the cost of a new gas insulated line in the UK. The listed items are those found in the pie-charts of the GIL lifetime costs in the main body of the report. They are based on the cost estimates from the case studies where cost assessments were made on the basis of installing GIL between real locations and across actual terrain.

| AC gas insulated line | |
|------------------------------------|--|
| GIL terminations (AIS) and testing | the build cost of supplying and erecting GIL terminations compatible with air insulated switchgear (AIS); it also includes the cost of testing the route |
| GIL terminal compound | cost of a new terminal compound to house the above terminations |
| Total fixed build costs | A |
| Equipment costs | GIL materials and equipment procurement, delivery to site, and assembly |
| Project launch + management | owner costs – facilitation costs that are required to allow the project to proceed – see fuller description under underground cable cost make-up |
| Build contingency (GIL) | 15% allowance for unforeseen costs, as described for underground cable make-up |
| Total variable build costs | B |
| Total build costs | C = A + B |
| Cost of power losses | Costs associated with having generating plant available to generate the energy losses (described further in Appendix D). |

| | |
|---------------------------------------|--|
| Cost of energy losses | Costs associated with the fuel burned in the power station to supply the conductor losses (described further in Appendix D). |
| Operation & maintenance | the cost of maintaining the GIL |
| Total variable operating costs | D |
| Lifetime cost | E = C + D |

In order to try and provide a true comparison between different technologies, three route lengths and three double-circuit power ratings were used. These route lengths were 3km, 15km and 75km, and the double-circuit power ratings were Lo (3190MVA), Med (6380MVA) and Hi (6930MVA). It is worth noting that for the two higher ratings, only tunnel installation is considered, as a direct-buried GIL circuit would not achieve the desired ratings.

I-6 Cost sensitivities

This section identifies the key factors to which the estimated prices are sensitive, and provides typical ranges within which the costs could vary, all else being equal.

It may be noted from the case study costs that the type of terrain (urban or rural) has a huge effect on the overall costs. However, the main area of interest for this report is the use of underground technology as a replacement for overhead line in the rural or less densely populated locations, typically where OHL would be normally used. With this in mind, in order to provide the reader with an appreciation of costs for urban areas, it was decided to assume that all routes consider a sensitivity analysis set between 100% rural to 100% urban, thus enabling outer values to be displayed in the study results.

For GIL, variable costs cover those cost items which principally vary by route length. Examples would be the length of equipment provided and also the length of trench or tunnel excavation.

The need for special constructions, such as directional drilling under roads or rivers may be expected to increase with route length and be dependent upon the specific location. The cost of these constructions can be significant. For the case studies, the cost of special constructions was in the region of 20–30% of total civil costs, though this amounts to only 5–6% of the total costs of the technology.

Both losses and maintenance costs can be largely considered to be variable costs, that is they vary with circuit length. However, maintenance costs can be considered minimal for GIL technology. Manufacturers are recommending only visual checks after approximately nine years and extended inspections after approximately 17 years. Some of the activities included within the extended inspections are to check external condition, check gas pressures, check gas moisture content and check the monitoring system.

Fixed costs for GIL projects are considered to be those associated with the substation terminations. In general, the 400kV substations within the UK are of air insulated or gas insulated switchgear design. For consistency with the other technologies, however, only the AI terminations were costed. In general, the cost differences between the AIS and GIS interface is relatively small with respect to the overall cost of the transmission circuits.

Costing figures received were generally based on the individual case studies described earlier within this report, but manufacturers were keen to highlight that, especially as there is very little costing experience for GIL on the UK network, the budget figures they provided to us should be considered to lie within a range of ±20%.

Direct-burial civil costs for GIL were only received from one source, a subcontractor of one of the manufacturers. However, these were reasonably consistent with similar costs for UGC when the differences in earthworks between UGC and GIL were taken into account, which provided additional confidence in the estimates.

I-7 Anticipated future developments

- Grid connections to offshore wind farms: Offshore wind farms typically provide large amounts of energy in remote locations. If the cost of GIL per km approaches that of OHL more closely, GIL could become a much more competitive technology for the transmission of bulk power with minimal losses over long distances.
- Some wind farms with capacities of several GW lie more than 100km from the coast. If a good track record can be established for subsea GIL, this technology could become a competitive technology for the transmission of bulk power subsea, again with minimal losses over long distances. Recent feasibility work has studied the use of GIL within an underwater tunnel or within individual steel pipe casings.

Appendix J Technology – Tunnels for UGC and GIL

J-1 An introductory note on tunnels, cables and gas-insulated lines

This appendix focuses upon the description, construction and cost estimating of tunnels. However, in the main costs report, we present the tunnelling costs together with those of underground cables (UGC) and gas insulated lines (GIL), so that the overall cost of a tunnelled transmission option may be easily seen.

J-2 Technology description

Tunnels offer a technically acceptable, albeit more costly, alternative to the direct burial of high voltage underground cables and gas insulated lines. The main advantages of a tunnel over a direct burial solution are that:

- it offers alternative routes for transmission network development where overhead line and direct buried cable options are restricted,
- it causes relatively low impact on existing surface infrastructure and the public, avoiding the risks and disruption associated with direct burial in trenches,
- it provides a safe and secure environment that minimises the risks of third-party damage,
- it allows access for transmission equipment maintenance with little or no impact on third parties, and
- it offers control of operating environment through forced ventilation.

The development of a typical tunnel undergrounding solution comprises the following key stages:

Feasibility studies

- initial desk studies and identification of possible tunnel routes
- identification of likely constraints both for construction and operation

Preliminary design

- ground and site investigations (tunnelling methodology, possible risks for construction and operation)
- ventilation studies (tunnel and shaft size optimisation)
- transportation and safety studies (inter-shaft distances)
- environmental studies (planning, spoil removal, noise, traffic)

Detailed design

- production of detailed designs, drawings and specifications

Procurement and construction

- technical and financial assessment of tender submissions
- construction of shafts, tunnels, head-houses and associated civil infrastructure
- installation of ventilation, drainage, lighting, tunnel transportation, security, etc.
- installation of cable or GIL
- commissioning of tunnel and cable system, issue of operating manuals and training in use of facilities

J-3 Civil works

Cable tunnels are generally constructed between vertical shafts. As shown in Figure 66, the civil infrastructure comprises:

- concrete-lined tunnel, generally circular in cross-section,
- vertical end-shafts (often also circular) for tunnel construction and accommodation of the cables or GIL,
- intermediate vertical shafts (if required) for additional ventilation and emergency egress, and
- headhouse structures over each shaft, which secure the shafts, protect the access facilities from the environment and accommodate the ventilation plant. It may also store a tunnel access vehicle.

Figure 66 – Cable tunnel outline schematic

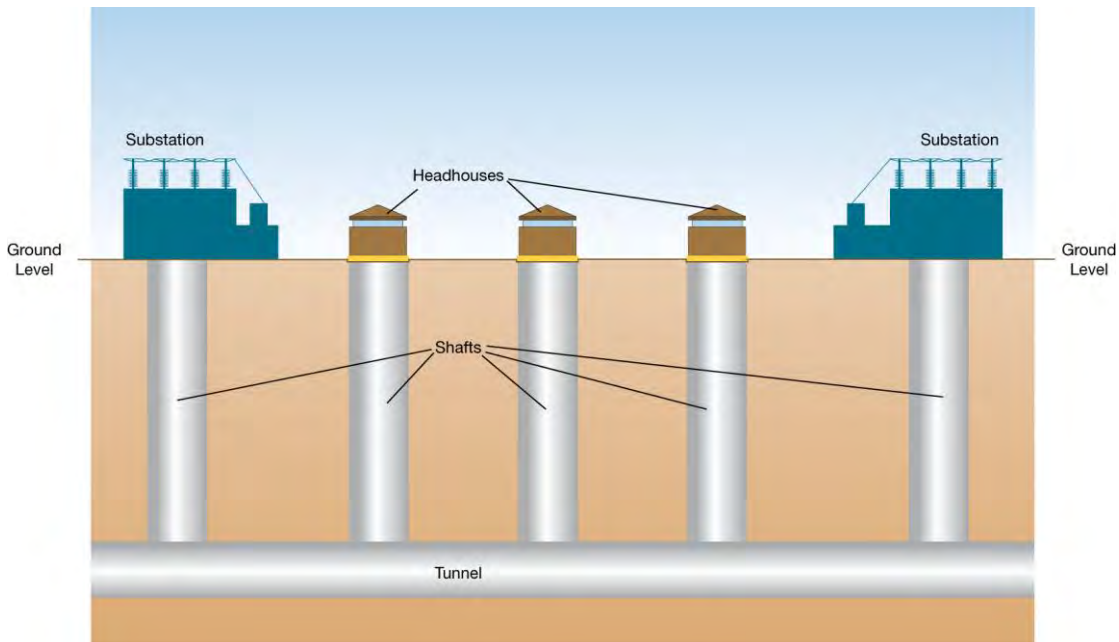

Shafts

During construction, three types of shaft are required: working shaft, reception shaft and intermediate shaft.

All shafts need to be of sufficient size to allow for:

- safe temporary access for construction work and operational access to the completed tunnel, and
- insertion and removal of mechanical and electrical services required for tunnel operation, including drainage sumps and pumps and tunnel ventilation fans located below ground, in the event of equipment failure.

In addition, the working and reception shafts need to be of an adequate size to:

- allow safe installation and removal of the tunnel boring machine and its associated equipment, and
- accommodate the plant/equipment required to remove the excavated soil and transport the various construction materials such as precast concrete tunnel linings to their operational location.

A number of different methods are used to construct shafts and tunnels. The method chosen for a particular project is largely dependent on whether the prevailing ground conditions are classified as soft ground or rock. For example, circular shafts in water-bearing soils are often

constructed using precast concrete segmental linings by a caisson⁶⁴ technique as shown in Figure 67.

Figure 67 – Hydraulic jacks on caisson technique shaft construction



Tunnel

Tunnels can be a variety of shapes and sizes and, although a circular section is often the most structurally efficient, a non-circular profile may provide a more cost-effective solution which optimises the use of space within the tunnel.

The diameter of the tunnel is determined by:

- the number of power conductors to be accommodated, their mechanical supports, and ancillary cabling,
- whether a tunnel transport system is required,
- the level of conductor cooling ventilation required, and
- future transmission strategies, including the possible future addition of further power circuits, or the replacement of cables at the end of their operational life with gas insulated line (GIL).

The horizontal alignment of a tunnel is mainly defined by consideration of land ownership, topography, geology, existing/future infrastructure and cost. The optimum tunnel alignment will provide the shortest practicable route between shafts whilst:

- minimising any potential impacts on third party infrastructure,

⁶⁴ Caisson technique for excavating tunnel shafts: This involves building the shaft lining in incremental rings at ground level, and forcing each complete ring into the ground with additional temporary weight or hydraulic jacks as the ground is excavated from within the shaft.

- minimising the number of easements required (route restricted to public highways or local authority land where possible),
- suit the existing ground conditions such that the short-term construction risks are minimised and both the structural and operational integrity of the tunnel are maintained throughout its service life, and
- accommodating various operational limitations, for example such as the tunnel transport system and minimum bend radii for GIL.

The type of tunnel and method of construction is largely influenced by the prevailing ground conditions. Modern tunnels are usually constructed using either precast concrete or steel segmental sections, or in-situ sprayed concrete, though the latter is only suitable in stable ground which is not exposed to groundwater.

Tunnelling in soft ground is usually carried out using tunnel boring machines (TBMs). These allow rapid excavation and construction of the tunnel structure whilst providing constant support to the exposed ground. There are essentially two types of TBM – open-face and closed-face. Open-face machines are used in stable non-water-bearing ground such as firm clays. They comprise a cylindrical steel shell, with either a mechanical excavator arm or a rotating cutter head at the front, and various hydraulic rams at the rear. Some rams push the TBM forward, whilst others erect the precast concrete segmental tunnel lining behind the machine.

There are two types of closed-face TBM design: an earth pressure balanced machine (EPBM) and a slurry machine. The latter is more suitable for medium/coarse granular soils, whilst an EPBM is the preferred choice for finer grain soil strata. They both operate on the principle of applying a regulated support pressure to the face of the excavation behind a sealed bulkhead, allowing a segmental concrete lining to be constructed behind the machine. Figure 68 shows an example of a closed-face EPBM.

Figure 68 – Head-section of TBM being lowered into working shaft



If necessary, tunnelling can be performed in both directions from a central shaft. Figure 69 shows an example of a central working shaft (15m internal diameter) from which a 4m internal diameter precast concrete lined tunnel is being constructed in both directions.

Figure 69 – Central shaft with tunnel constructed in both directions



Tunnel safety

The safety features installed in a tunnel will depend on the requirements of the project. However, the main concern is to prevent risk where possible, and to facilitate the exit of personnel when danger is present. Since the distance between exit shafts can be up to 4km, tunnel vehicles may be installed, to carry personnel and equipment to the nearest safe exit within a reasonable timescale. Figure 70 shows one example of such a vehicle.

Figure 70 – Tunnel vehicle suspended from monorail



The completed tunnel will contain communication systems and possibly a vehicle monorail as well as the power circuits for which it was designed. An example of a completed tunnel is shown in Figure 71. This example has supports for six future power cables in addition to the six already installed.

Figure 71 – Completed tunnel: vehicle monorail and power cables installed



Head-house/head-works structure

The head-works are the structures that allow routing of the power circuits to and from the entry and exit shafts. As the power cables arrive at the top of the shaft they are turned from their vertical orientation and extended horizontally to the substation via either cable troughs or direct burial trenches.

At ground level the top of the shaft is usually incorporated within a head-house structure which provides accommodation for the various tunnel operating facilities which may include some or all of the following:

- control room
- communications room
- storage room (may include storage capacity for the tunnel vehicle)
- uninterrupted power supplies (UPS) room
- shaft lift
- staircase ventilation plant

- main tunnel ventilation plant, including attenuation ducting and intake/exhaust louvres
- welfare and washing facilities
- lifting facilities with direct access for full depth of shaft

The design of the head-house will depend upon the extent of the facilities to be provided and local planning constraints and requirements. One example is shown in Figure 72.

Figure 72 – Completed shaft head-house, within a secure compound



J-4 Application of the technology

Cable tunnels are becoming the preferred option – and in certain circumstances the only viable option – for the routing of high voltage power lines below dense city environments. Digging trenches within the streets and major highways of modern urban environments is fraught with risk to road users and to the existing subterranean services, and will, of course, cause considerable traffic management issues for the period that the trenches are open. Tunnels avoid all these issues by passing beneath the city.

Tunnelling is also used to cross below busy transport corridors such as rail tracks and motorways, and tunnelling may provide a cost-effective solution for crossing below rivers and other topographical features.

The installation of power cables in tunnels may be the preferred solution to overcome local environmental concerns or where security of the asset is of particular concern.

A tunnel can also be designed to provide spare capacity for meeting future demands on the cable transmission system. Thus, where a detailed cost-benefit analysis shows this approach to be of value, tunnels can allow future upgrading of the network without any further serious disruption to traffic or local communities.

However, there are other subsurface boring methods, besides tunnelling, which may be feasible for undergrounding transmission circuits. These include:

- horizontal directional drilling,
- auger boring,
- pipe jacking, and
- micro tunnelling.

J-5 Cost make-up

This section identifies the key cost components of a new tunnel in the UK. They are categorised as follows:

| | |
|---------------------------------------|--|
| Tunnel | |
| Tunnel + shaft | fixed costs associated with the construction of a tunnel and associated shafts, detailed immediately below this table |
| Tunnel boring machine costs | fixed costs associated with the provision of one or more tunnel boring machines |
| Tunnel PM + overheads | fixed costs associated with tunnel project set-up, project management and overhead costs, detailed immediately below this table |
| Total fixed build costs | A |
| Tunnel + shaft | variable costs associated with the construction of a tunnel and associated shafts, detailed immediately below this table |
| Tunnel boring machine costs | variable costs associated with the provision of one or more tunnel boring machines |
| Tunnel PM + overheads | variable costs associated with tunnel project set-up, project management and overhead costs, detailed immediately below this table |
| Total variable build costs | B |
| Total build costs | C = A + B |
| Cost of power losses | costs associated with having generating plant available to generate the energy losses (described further in Appendix D) |
| Cost of energy losses | costs associated with the fuel burned in the power station to supply the tunnel cooling fan losses (described further in Appendix D) |
| Operation & maintenance | the cost of maintaining the tunnels |
| Total variable operating costs | D |
| Lifetime cost | E = C + D |

Tunnel and shaft:

- Tunnelling
 - preliminary ground investigation
 - surveys
 - accommodation for PM
 - contractor final design – tunnel section
 - contractor set up main site
 - contractor contract management and site management
 - tunnel excavation and lining
 - tunnel equipment.
- Shafts
 - contractor final design – per shaft
 - contractor set up shaft sites
 - drive shaft construction
 - receiving shaft construction
 - intermediate shaft construction
 - head-house drive shaft
 - head-house receiving shaft
 - head-house intermediate
 - tunnel vent system
 - tunnel vehicle system
 - power distribution for tunnel and shaft head-houses
 - shaft equipment
 - detection systems
 - small tools and consumables
 - testing and commissioning
 - final documentation and manuals

Tunnel boring machine

- TBM supply

Project set-up and miscellaneous costs

- Early stage set-up
 - client need case, outline design
 - planning consent, inc. environmental baseline report
 - client project management, inc. contract and tender docs

- Contractor set-up
 - insurance and bonds
 - detailed site investigations and monitoring
- Miscellaneous
 - head office overheads @ 6.5% of construction costs
 - profit @ 5% of construction costs
 - risk contingency @ 5% of construction costs.

Other costs that may apply – not included in our estimates

We have estimated in this document the “normal expected” lifetime costs of a power transmission tunnel. There are other costs, however, which may or may not apply to any given tunnel project, and some of these would be significant, either financially, or in terms of their effects on the construction or operational schedule, if they materialised. Three of these are identified here, for the consideration of the reader, though they are not included in the cost estimates in the main section of the report:

- public enquiries
- dealing with contaminated ground
- tunnel damage from subsequent piling

Regarding this last item, where development occurs above an existing tunnel, the tunnel is vulnerable to damage from piled foundations. Such an event would typically include full or partial collapse of the tunnel lining, and damage to the cables and mechanical services within the tunnel. Depending upon whether the ground was stable and dry, or unstable and wet, safety concerns could range from crushing to flooding, and repair costs of tunnel and cable could vary from around £100,000 to more than ten times that.

J-6 Cost sensitivities

The primary prices given in the main section of the report are based on a 4m internal diameter tunnel, constructed through mixed ground conditions below groundwater table comprising:

- cohesive and non-cohesive soils of the Lambeth group,
- dense Thanet sand, and
- chalk.

Tunnel construction costs (assuming a 4m internal diameter precast concrete segmental lining constructed by TBM) are particularly sensitive to the following variables.

- Ground conditions
 - primary cost assumption: mixed wet ground
 - cost reduction sensitivity: hard rock, -30%

- further cost reduction sensitivity: stiff/firm competent clay soils provide good ground conditions for construction – possible reduction of base cost of up to 40%
- Alignment
 - primary cost assumption: minimum turning radius of 250m
 - cost reduction sensitivity: increased minimum turning radius of 1000m
 - cost increase sensitivity: decreased minimum turning radius of 150m
- Tunnel diameter (comparison based on analysis of all-in tunnelling rates given in the Infrastructure Cost Review – technical report published in December 2010; Annex G):
 - primary cost assumption: 4m internal diameter tunnel
 - cost reduction sensitivity: 3m internal diameter tunnel
 - cost increase sensitivity: 5m internal diameter tunnel

J-7 List of costing sources

Data sources include the following.

- The key source of information for the cost sensitivity assessments has been the document produced by HM Treasury Infrastructure UK titled: Infrastructure Cost Review – Technical Report, HM Treasury Infrastructure UK, and published in December 2010. Annex G of the report refers to cost data obtained from various sources including surveys.
- A benchmarking exercise carried out by the British Tunnelling Society. This exercise reviewed 14 tunnels in the UK and 21 tunnels in other EU countries, relating to rail, highway, water and power sectors.
- Parsons Brinckerhoff tunnel specialists' experience

The HM Treasury technical report referred to above states that for tunnels of 3m diameter or greater, the primary influence on the average unit rate for the cost of a tunnel is the diameter. Other factors such as length, ground conditions, tunnelling method and lining type were found generally to have less impact on cost.

Reference costs have been based on tender prices for a 4m internal diameter precast concrete segmental lining approximately 7km long constructed in mixed ground conditions comprising: clays, water-bearing sands and chalk.

J-8 Anticipated future developments

Regarding tunnel safety, some tunnels are designed to include a maintenance/safety evacuation vehicle which, in the past, have been suspended from a track on the ceiling of the tunnel. Experience has shown that, since the tunnel environment is hostile to their control and propulsion systems, these battery-operated vehicles are often not operational at the moment that they are required. One development being considered is to store these vehicles above ground, in a more benign environment, and where they can more readily be tested

and maintained. Though their performance may thus be enhanced, there would be additional cost for the systems to readily deliver the vehicle from storage to the tunnel ready for use.

Appendix K ENTSO-E – Europacable Joint Paper

K-1 ENTSOe – Europacable joint paper⁶⁵

A paper, “Joint paper: Feasibility and technical aspects of partial undergrounding of extra high voltage power transmission lines” was published in December 2010 as a joint paper between ENTSO-E⁶⁶ and Europacable.⁶⁷ This paper is of particular interest as it is an agreed statement between two organisation representing groups within the industry.

The following extract has been taken from the executive summary of the joint paper and commented upon insofar as they have relevance to the findings of this study.

Following an invitation by the European Commissioner for Energy, Mr Andris Piebalgs, in December 2009, ENTSO-E and Europacable have jointly produced this paper, outlining the feasibility and technical aspects of partial undergrounding of Extra High Voltage (EHV) tower transmission lines (AC 220–400kV).

The objective of this document is to provide an authoritative source of information for future transmission projects, which shall be made available to any interested party.

It provides information on the feasibility and technical aspects of partial undergrounding of EHV transmission lines (AC 220–400kV) based on the expertise of cable systems manufacturers and on the experience gained by the European Transmission System Operators with the inclusion of underground EHV cables in their systems.

The document focuses on the use of 400kV XLPE cables, a technology that performs well based on established international standard IEC 62067 and is available for transmission projects.

It is recognised that each transmission project is unique due to its specific features. Given the complexity of integrating partial undergrounding into high voltage transmission systems, all projects require a case by case analysis of the technical specifications.

From a technical perspective, partial undergrounding can be a viable option for transmission projects of vital interest for the development of the EU transmission network.

Reliability and costs are of the highest importance. The use of IEC standards for testing and qualification aims to ensure the reliability of the cable systems. Monitoring systems are available to further increase reliability. Depending on the type and scope of failure, repair times for cables can be longer than for overhead lines. As with any transmission link, also partial undergrounding requires a risk assessment by the TSO of integrating the link into the system.

⁶⁵ “Joint paper: Feasibility and technical aspects of partial undergrounding of extra high voltage power transmission lines”, ENTSO-E Europacable paper, Brussels, December 2010, <http://tinyurl.com/7p6t638>

⁶⁶ ENTSO-E (European Network of Transmission System Operators for Electricity) is an association of transmission system operators including National Grid Electricity Transmission plc, System Operation Northern Ireland Ltd, Scottish and Southern Energy plc and Scottish Power Transmission plc.

⁶⁷ Europacable, an organisation registered in the UK, is a lobby organisation, representing the wire and cable industry. Its members include General Cable Europe, Nexans and Prysmian.

The Underground Cable (UGC) investment cost is typically 5 to 10 times higher than Overhead Line (OHL) costs. These cost ratios are directly related to the capacity of the link. Factor down to 3 can be reached for links with limited rating and under special favorable conditions for cable laying or in case of expensive OHL. Factors above 10 can be reached for high capacity double circuit links and if specific structures are needed.

Where partial undergrounding is considered, the above multiples apply to the undergrounded part of the link; therefore any decision for partial undergrounding needs to take the whole economical balance of the transmission projects into account. Such a decision must also be carefully analysed with all stakeholders, in particular the regulators whose authorization is in many cases needed by the TSO to ensure an appropriate cost recovery through the transmission tariff.

*The case study provides an example of UGC dimensioning in order to comply with the requirements of a typical double circuit 400kV OHL carrying 2*2500MVA which can be considered today as a typical solution used for the development of the European transmission system.*

It shows that four cable systems would be generally needed leading to a corridor of 20–25 meters on which no deeply rooted trees may be planted and appropriate access must be managed.

This study has found that XLPE insulated cables are the predominant type of AC underground cable being manufactured and installed. Operational experience is being gained.

This study has found the following from the case studies:

- Costs will vary on a project-by-project basis and this is also a finding in paragraph 5 of the joint paper executive summary.
- This study considers that underground cable repair times for a serious fault (i.e. insulation breakdown) may be expected to be longer than for an overhead line. Evidence submitted to the study indicates that return-to-service times (experienced by Transco in Abu Dhabi) are in the order of 2 months for AC UGC, and failures in GIS equipment have taken up to 6 months to repair (TSO 50Hertz Germany).
- This report has found that the build cost of the Lo (3190MVA) for a 75km link is 6.9:1, and for the Med (6380MVA) the ratio is 10.6:1. The joint paper estimates an investment cost ratio⁶⁸ (which we assume is comparable) of between 5:1 and 10:1 for a 5000MVA connection. The joint paper does not give actual cost values but the unrefined simplification of cost ratios falls within the wide band presented by the joint paper.
- The joint paper (not in the executive summary) considers the cost of a tunnelled cable installation and gives a cost factor to overhead line of more than 15:1. This report finds that the build cost for cables in tunnels (deep tunnels not open cut) are 14.4:1 to 16.0:1

⁶⁸ The joint paper costs do not include for termination compounds. In order to obtain the nearest ratio equivalent to the joint paper's "investment ratio", the 75km connection build ratios from this study have been used, where the cost terminal compounds are less significant.

- The authors agree with the joint paper that deeply rooted trees should not be allowed to grow near the cables.
- The joint paper considers that a 5000MVA cable connection may be placed in a swathe of 20 to 25m. The method of installation indicated in the joint paper does not include for a haul road or swathe water interceptor drains but shows the as-installed arrangement rather than the construction arrangement.

It can be seen that the cost ratio information contained within the joint paper is not significantly at variance with the ratio results given in this study.

Appendix L Planning and Environment

L-1 Introduction

This appendix outlines the planning framework that transmission consent applications need to comply with, and then summarises the key environmental issues likely to result from a new transmission connection.

L-2 The planning framework

Planning context

This section provides a summary of the planning context for the electricity transmission technologies reviewed by this costing study.

The summary focuses on the national level, and the Government's planning reform agenda. It does not cover secondary legislation, local authority planning policy and guidance, or any site-specific issues since, whilst these locational factors could have significant impact on energy infrastructure project consents, their details are beyond the scope of this generic report.

Infrastructure need

The UK's infrastructure need is set out in the National Infrastructure Plan 2011. In the section of the plan on sectoral performances, the Government states that current strengths of the electricity market are a "reliable and secure supply, adequate current generation, spare capacity margins and low prices (relative to Europe)". The challenges are "falling generation spare capacity margin in the future" and "the increasing need to de-carbonise the electricity system" (page 18).

In the section of the plan on the UK's energy systems, the Government's vision is "a secure, low carbon and affordable energy system" (page 52). Under "Ambitions", the Government aims to:

- *maintain the security of supply of the electricity system, by ensuring that there is adequate reliable capacity in place to meet peak demand, and*
- *reduce the carbon intensity of the electricity system at least cost to consumers while reducing vulnerability to external commodity price and supply shocks, through a low carbon and diverse generation mix. The Government is committed to reducing UK greenhouse gas emissions by 80 per cent by 2050 (compared to 1990 levels) (National Infrastructure Plan 2011, page 57).*

Planning reform

One of the Government's perceived "barriers to efficient delivery" of infrastructure projects is planning and consents. The National Infrastructure Plan states that:

the delivery of effective, timely and high value for money infrastructure projects requires a transparent planning and consents regime which is able to respond quickly to the need for new infrastructure (page 17).

An “efficient” planning regime is seen as “vital to encourage private investment” (page 17). Part of the move to a more efficient planning regime is the Government’s reform of the planning system “through National Policy Statements that set out energy needs ... that will help guide the planning process, so that if sound proposals come forward in sensible places, they will not face unnecessary hold-ups” (page 26).

Fast track planning approach – the Infrastructure Planning Commission

The planning legislation impacting on transmission projects consists of the Planning Act 2008, the Localism Act 2011 (which amends some of the 2008 Act), secondary legislation, and national policy and guidance from the Government (mainly from the Department of Communities and Local Government).

Energy infrastructure projects are usually considered Nationally Significant Infrastructure Projects (NSIPs), which require national consent in the form of a Development Consent Order (DCO).

The IPC has been an essential element of the reformed planning process, and was launched in October 2009. It is an independent public body comprising a chair (Sir Michael Pitt) and approximately 40 commissioners. The IPC will make recommendations in accordance with the new National Policy Statements now in place for each type of infrastructure.

Geographical coverage

The IPC examines infrastructure projects in England and Wales. While energy policy is generally a matter reserved to UK Ministers, Scotland has its own decision-making process for infrastructure. In Northern Ireland, planning consents for energy infrastructure are devolved to the Northern Ireland Executive. The National Policy Statements do not apply to Scotland or Northern Ireland.

What needs consent?

The Planning Act 2008, as amended by the Localism Act 2011, is the primary legislation. It sets out the thresholds for NSIPs in the energy sector. The Act empowers the IPC to examine applications and make decisions on nationally significant energy infrastructure projects.⁶⁹

If the project is not considered to be an NSIP, then the normal local planning consent regime or Electricity Act regime still applies. This includes planning permission, listed building consent and other development and environmental consents, as appropriate.

⁶⁹ Note: This “electricity lines” terminology relates specifically to **overhead** electricity lines. Proposed underground lines are, of themselves, classed as permitted development, and so do not require a DCO under the Planning Act. However, if they should form part of a new infrastructure project which is the subject of an application under the Act, they may be included in the overall consideration. In addition, underground cable sealing end compounds may require planning permission from the local authority if not included in a DCO.

Consultation

Consultation is an essential element of the consent process. Indeed, the process is “front-loaded”, with substantial public and stakeholder consultation required before the application for a DCO is submitted to the IPC.

The IPC advises that consultation should be iterative and phased, and promoters must produce a consultation report detailing how they have complied with the consultation requirements of the Act. The consultation report is one of the application documents.

IPC abolished

The Localism Act made one major change to the planning process as well as a number of other amendments to the 2008 Act.

The major change was the abolition of the IPC, and the creation of a Major Infrastructure Planning Unit (MIPU) within the existing Planning Inspectorate in April 2012. From that date the MIPU will consider applications for DCOs, and will make recommendations to the Secretary of State, but it will be the Secretary of State, rather than the MIPU, who will be responsible for the final decisions.

National policy statements: EN-1 and EN-5

National policy statements (NPSs) are produced by the Government. They include the Government’s objectives for the development of nationally significant infrastructure, including that for energy. Each NPS sets out policy and gives the reasons for the policy. Each also includes an explanation of how the policy takes account of other Government policy relating to the mitigation of, and adaptation to, climate change.

There are to be 12 national policy statements, including six dealing with energy, which have been published. The two specifically related to electricity transmission, and which form the primary basis for IPC decision-making on applications for new overhead lines, are:

- EN-1 Overarching Energy NPS
- EN-5 Electricity Networks Infrastructure NPS

EN-1 and EN-5 provide the primary basis for decisions taken by the IPC and the Secretary of State. They set out the key considerations for developers proposing new transmission lines, including routeing, and the “Holford rules” for mitigating landscape impact.

L-3 Key environmental issues

The following list recognises that all the technologies being considered by this report have the potential to cause environmental impact.

Of course, there will be circumstances where some of these effects are less evident, or do not occur at all, and others where the effect is more pronounced, or more likely to occur than indicated here. However, this list of typical impacts assumes that, in balancing the conflicting requirements of electricity users and the individuals past whom the transmission circuits are brought, a professional and considerate approach is taken to establishing the need,

assessing the land use and amenity value, choosing the transmission technology, route planning, stakeholder consultation, construction, subsequent operation.

Table 12 – Potential environmental impacts from HV transmission

| Potential for impact |
|--|
| Land use |
| construction duration |
| disruption to agricultural activity |
| land take |
| field boundaries |
| buildings |
| drainage patterns |
| Geology and soils |
| soil cover |
| material disposal |
| Water |
| disruption to groundwater |
| surface water |
| Ecology |
| loss of habitat (construction and operation) |
| risk to flora (construction and operation) |
| risk to mammals |
| bird/bat strike |
| risk to aquatic ecosystems |
| Landscape and visual |
| landscape character |
| landscape features |
| visual impact (construction and operation) |
| access |
| communities |
| Cultural heritage |
| archaeological resources |

| Potential for impact |
|--|
| heritage resources |
| Traffic |
| traffic (construction and operation) |
| Noise and vibration |
| noise (construction and operation) |
| vibration (construction) |
| Air quality |
| air quality (construction and operation) |
| Communities |
| EMF |
| property prices |
| severance (construction and operation) |

One should note that there may be instances where positive impacts occur as a result of the presence of the transmission technologies, for example the use of towers as nesting sites or the enabling of development in an area where previously there was none.

The relative significance of these impacts will vary considerably on a site-specific basis. The above table provides a list of generic impacts for consideration; with mitigation, the scale and significance of many of the impacts will reduce. However, an environmental impact assessment would be required to obtain a full and detailed understanding of the impacts resulting from any transmission scheme.

Appendix M Bibliography

M-1 Generic references

1. "Case Study 1 – new cable tunnel", National Grid Publication, <http://tinyurl.com/85haoaa>
2. "Electric Cables Handbook", Bungay, E. et al., BSP professional Books, 2nd Edition, London, 1990, ISBN 0-632-02299-X
"Joint paper: Feasibility and technical aspects of partial undergrounding of extra high voltage power transmission lines", ENTSO-E Europacable paper, Brussels, December 2010, <http://tinyurl.com/7p6t638>
3. "Updating the Cost of Capital for the Transmission Price Control Rollover", Ofgem – Phase 2 Final Report, Feb 2011

M-2 References relating to costs of losses

4. National Grid 2011 Strategic Optioneering Report for the proposed new Hinkley Point C connection, <http://tinyurl.com/7lh2tdr>

M-3 References relating to costs of overhead lines

5. "Parametric Studies of Overhead Transmission Costs" – CIGRÉ Working Group 09 (Overall Design) of Study Committee 22 – Published in Electra No.136 dated June 1991
6. "Unit Costs of Constructing New Transmission Assets at 380kV within the European Union, Norway and Switzerland" – ICF Consulting – Published in October 2002
7. London Metal Exchange Limited – Primary aluminium price graphs (historical), <http://tinyurl.com/5toywjr>

M-4 References relating to costs of underground cables

8. IEC60287
9. Beaulieu Denny APL 5/16
10. The Electricity Safety, Quality and Continuity Regulations 2002, <http://tinyurl.com/7j9w7ax>
11. Installation Requirements for Power and Auxiliary Cables, National Grid Internal Technical Specification, TS 3.05.07 issue 6, April 2011
12. "Development of a New 380kV Double Circuit XLPE Insulated Cable System in the Netherlands", Koreman C. G. A. et al., B1-107, CIGRÉ, Paris, 2006
13. "Red Electrica Installs Spain's First 400kV Cable System", Granadino R., Red Eléctrica de España, Transmission and Distribution World, Aug 1, 2005, <http://tinyurl.com/7tmc7cj>
14. "Statement of Accounts", London Development Agency, 2008, <http://tinyurl.com/74u5hto>

15. "Programme Baseline Report Summary", Olympic Delivery Authority, September 2009
16. "400kV Vienna, The Vienna 400kV North Input" Vavra J. et al., B1-101, CIGRÉ, Paris, 2006
17. "APL/PTH-41, Proposed Beauilly to Denny 400kV Overhead Transmission Line, The use of underground cable as an alternative to overhead line: Perth & Kinross, Final report", PB, September 2007
18. "The 2001 Kista Blackout: Corporate Crisis and Urban Contingency", E. Deverell, Publishers Elanders Gotab, Stockholm 2003, ISBN 91-89683-06-4, <http://tinyurl.com/73wltz6>
19. "Fire Accidents of the Power Cable Line in Tunnel and Preventative Methods" Junhua L, et al., IEEE Electrical Insulation Conference, Montreal, QC, Canada 2009
20. "Operational Experience of High Voltage Power Cable Systems in Berlin And Future Planning for Bulkpower Lines", Presentation, Euroforum Conference, W Fischer, 50 Hertz, Nov 2010, Brussels
21. "The Highland Council, Cairngorms National Park Authority and Scottish Natural Heritage: Undergrounding of EHV Transmission Lines", Jacobs Babbie, 2009
22. "Update of service experience of HV underground and submarine cable systems", Publication TB 379, Working group B1.10, CIGRÉ, Paris, 2009
23. "Return of Experience of 380kV XLPE Landcable Failures", Meijer, S. et al., paper A.3.7, JICABLE, Paris, 2011
24. "Challenges at the Planning, Development and Performance at the 275kV XLPE Cable Project in the City of Liverpool", Ebert, S. et al., Paper B.5.4, JICABLE, 2011
25. "Natural and forced-cooling of HV underground cables: UK practice", Williams D.E., IEE Proc, Vol. 129, Pt. A, No.3 May 1982
26. Paper A.2.2, P. D. Radhakrishna et al., JICABLE 95, Paris, 1995
27. "A New Backfill Material with an Extremely High Thermal Conductivity", Brakelmann H. et al., Paper C.10.2, JICABLE 2011, Paris, 2011
28. "Upgrading Quality of 275kV Y-Branch Pre-Fabricated Transition Joint", Nakanishi T. et al., JICABLE 07, Paris 2007
29. "Impact of moisture migration on the current rating of high operating temperature cables", Pilgrim J. et al., Paper C.9.6, JICABLE 11, Paris, 2011
30. "Investigation into the benefits of installing high operating temperature cables in tunnels", Pilgrim J. et al., Paper C.10.1, JICABLE 11, Paris 2011
31. "Feasibility study for 500kV AC underground cables for use in the Edmonton region of Alberta, Canada", B. Gregory, A. Williams, Cable Consulting International, Feb 2010, <http://tinyurl.com/7no2u5p>
32. "Design Development and Testing of the First Factory Made High Temperature Superconducting Cable for 115kV, 400MVA", M. Nassi et al., Paper 21-202, CIGRÉ Conference 1998, Paris
33. "Design, Installation and Operation of World's First High Temperature Superconducting Power Cable in a Utility Power Network", J. Ostergaard and O. Tonnesen, Paper 21-205, CIGRÉ Technical Conference 2002, Paris

34. "Verification Tests of a 66kV High-TC Superconducting Cable System for Practical Use", S. Honjo et al., Paper 21-202, CIGRÉ Technical Conference, 2002, Paris
35. "Demonstration and Verification Test Results of 500m HTS Power Cable", M. Ichikawa et al., Paper B1-104, CIGRÉ Conference, 2006, Paris
36. "Development of Superconducting Cable System for Bulk Power Delivery", S. I. Jeon, et al., Paper B1-06, CIGRÉ Conference, 2006, Paris
37. "Type Test Results for 22.9kV 50MVA HTS Cable System in Korea", H. M. Jang et al., Paper B1-108, CIGRÉ Technical Conference, 2008, Paris
38. "Installation and Commissioning of Triax HTS Cable", D. Lindsay et al., Paper A.3.2, JICABLE 2007 Conference, Versailles
39. "Operating Experience of 13.2kV Superconducting Cable System at AEP Bixby Station", D. Lindsay et al., Paper B1-107, CIGRÉ Conference, 2008, Paris
40. "Superconducting Cables – Status and Applications", J.-M. Saugrain et al., Paper A.3.1, JICABLE 2007 Conference, Versailles
41. "Development and Demonstration of a Long Length Transmission Voltage Cold Dielectric Superconducting Cable to Operate in the Long Island Power Authority", F. Schmidt et al., Paper A.3.4. 2007 JICABLE Conference, Versailles

M-5 References relating to costs of subsea cables

42. "Electric Cables Handbook", Bungay and McAllister, BSP, 1992, ISBN 0-632-02299-X
43. "Submarine Power Cables, Design Installation, Repair Environmental Aspects", Worzyk T., Springer 2009, ISBN 978-3-642-01269-3
44. "Solid DC Submarine Cable Insulated with Polypropylene Laminated Paper (PPLP)", Hata, R., SEI Technical Review, Number 62, June 2006, <http://tinyurl.com/7946qo8>
45. "Third Party Damage to Underground and Subsea Cables", WG B1.21, Technical Brochure 398, CIGRÉ, Paris, December 2009
46. Mutual Energy Press release 26 August 2011, <http://tinyurl.com/76bqhyg>
47. Mutual Energy press release 7 July 2011, <http://tinyurl.com/835f7nn>
48. Mutual Energy Press Release 16 December 2011, <http://tinyurl.com/7fwm29t>
49. Prysmian Press Release, <http://tinyurl.com/7j8p3bb>
50. HVDC Western Interconnector website, <http://tinyurl.com/7mo7wny>
51. Scottish Government, Key Policies and Drivers, 29 Dec 2012, website <http://tinyurl.com/7hntm6c>
52. Subsea cable-laying vessel website: <http://tinyurl.com/6rxrj32>
53. "Technical Feasibility and Research & Development Needs for ± 1000 kV and above HVDC System", Nayak N., et al., paper B4-105, CIGRÉ, Paris, 2010

M-6 References relating to costs of HVDC converters

- 54. Impacts of HVDC Lines on The Economics of HVDC Projects, CIGRÉ Brochure 388, WG B2/B4/C1.17, August 2009
- 55. Index of Operating Schemes, CIGRÉ B4 Working Group, October 2009

M-7 References relating to costs of GIL

- 56. Dena Grid Study II
- 57. General GIL description, Siemens
- 58. Grid connection of offshore wind farms – A feasibility study on the application of power transmission pipelines. Siemens

M-8 References relating to costs of tunnels

- 59. Benchmarking exercise carried out by the British Tunnelling Society
- 60. Tender data from recent UK cable tunnel projects (details commercially sensitive)
- 61. Infrastructure Cost Review: Technical Report, HM Treasury Infrastructure UK, December 2010

M-9 References relating to environment and planning

- 62. The Planning Act 2008, <http://tinyurl.com/76o5aq6>
- 63. National Infrastructure Plan 2010, <http://tinyurl.com/7cmx9ld>
- 64. The Localism Act 2011, <http://tinyurl.com/8x3a9pt>
- 65. National Policy Statements for Energy – EN-1 and EN-5, <http://tinyurl.com/6mwsuyt>

Appendix N Letters sent by DECC

Four letters were sent by DECC to organisations in four different categories:



Mr aaa – **Letter 1 – All UK Companies**
Title bbb
Company Name XXX
Address of XXX

Charles Hendry MP

Minister of State

Department of Energy & Climate Change
3 Whitehall Place
London
SW1A 2AW

www.decc.gov.uk

Your ref:

Our ref:

August 2011

UK ELECTRICITY TRANSMISSION TECHNOLOGIES COSTS STUDY

I request your assistance with the provision of cost information on the construction and use of electricity power transmission technologies.

The UK Government has arranged for Parsons Brinckerhoff (PB), an international engineering consultancy, to produce a comparison study of the different technologies for the transmission of electrical energy. The study will consider, among other things:

- **The cost of each transmission technology (construction and lifetime),**
- **Impacts from the use of each technology, and**
- **Developing technologies.**

Parsons Brinckerhoff will approach a number of organisations over the coming weeks to request data – particularly costing data – that will be used to inform the study. I would be most grateful for any assistance you can provide to ensure a supportive response from departments within your organisation.

Although one of the key drivers for this study is the push to connect renewable energy sources, any new applications for transmission connections or reinforcements, whether domestic or international, are likely to be faced with the challenge of balancing cost with environmental impact. This study has thus been commissioned to inform all those involved in the design, planning and consenting of

new transmission connections. The intention is to publish the results towards the end of the year.

It may be helpful to know that I am writing, with a similar request, to other key suppliers and users of transmission technologies around the world.

If you or your colleagues should have any queries regarding this request, either now or following any approach regarding cost data, please contact Ian Lomas here at the UK Department of Energy and Climate Change (email: ian.lomas@decc.gsi.gov.uk; tel: +44 (0) 300 068 5827).

I thank you in anticipation,

CHARLES HENDRY



Mr aaa – **Letter 2 – Overseas Equipment Suppliers**
Title bbb
Company Name XXX
Address of XXX

Charles Hendry MP

Minister of State

Department of Energy & Climate Change
3 Whitehall Place
London
SW1A 2AW

www.decc.gov.uk

Your ref:

Our ref:

August 2011

UK ELECTRICITY TRANSMISSION TECHNOLOGIES COSTS STUDY

As communities around the world strive to harness renewable energy resources, electricity transmission companies face increasing public opposition to the construction of new overhead lines to connect the new generators. Faced with this challenge, the UK Government has commissioned a comparison study of transmission technologies, and I wish to request your assistance with the provision of information to the study – particularly on the costs associated with transmission circuit construction and lifetime running.

The study will be performed by Parsons Brinckerhoff (PB), an international engineering consultancy, and their work will consider, among other things:

- **The cost of each transmission technology (construction and lifetime),**
- **Impacts from the use of each technology, and**
- **Developing technologies.**

Parsons Brinckerhoff will approach a number of organisations over the coming weeks to request data that will be used to inform the study, and I would be most grateful for any assistance you can provide to ensure a supportive response from departments within your organisation.

Although one of the key drivers for this study is the push to connect renewable energy sources, any new applications for transmission connections or reinforcements, whether domestic or international, are likely to be faced with a similar challenge. This study has thus been commissioned to inform all those involved in the design, planning and consenting of new transmission connections. The intention is to publish the results towards the end of the year.

It may be helpful to know that I am writing, with a similar request, to other key transmission technology stakeholders around the world.

If you or your colleagues should have any queries regarding this request, either now or following any approach regarding cost data, please contact Ian Lomas here at the UK Department of Energy and Climate Change (email: ian.lomas@decc.gsi.gov.uk; tel: +44 (0) 300 068 5827).

I thank you in anticipation,

CHARLES HENDRY



Mr aaa – **Letter 3 – Overseas TSO**
Title bbb
Company Name XXX
Address of XXX

Charles Hendry MP

Minister of State

Department of Energy & Climate Change
3 Whitehall Place
London
SW1A 2AW

www.decc.gov.uk

Your ref:

Our ref:

August 2011

UK ELECTRICITY TRANSMISSION TECHNOLOGIES COSTS STUDY

I wish to request your assistance with the provision of cost information on the construction and use of electricity power transmission technologies.

The UK Government has arranged for Parsons Brinckerhoff (PB), an international engineering consultancy, to produce a comparison study of the different technologies for the transmission of electrical energy. The study will consider, among other things:

- **The cost of each transmission technology (construction and lifetime),**
- **Impacts from the use of each technology, and**
- **Developing technologies.**

Parsons Brinckerhoff will approach a number of organisations over the coming weeks to request data – particularly costing data – that will be used to inform the study. I would be most grateful for any assistance you can provide to ensure a supportive response from departments within your organisation.

One of the key drivers for this study is the push for renewable energy. As we strive to harness these new energy resources, transmission network extensions are required to connect this new generation. However, these developments come at a time of unprecedented public reaction against new high voltage overhead lines, and the study has been commissioned to inform the debate. The intention is to publish the results towards the end of the year.

It may be helpful to know that I am writing, with a similar request, to other key suppliers and users of transmission technologies around the world.

If you or your colleagues should have any queries regarding this request, either now or following any approach regarding cost data, please contact Ian Lomas here at the UK Department of Energy and Climate Change (email: ian.lomas@decc.gsi.gov.uk; tel: +44 (0) 300 068 5827).

I thank you in anticipation,

CHARLES HENDRY



Mr aaa – **Letter 4 – Overseas Industry Associations**
Title bbb
Company Name XXX
Address of XXX

Charles Hendry MP

Minister of State

Department of Energy & Climate Change
3 Whitehall Place
London
SW1A 2AW

www.decc.gov.uk

Your ref:

Our ref:

August 2011

UK ELECTRICITY TRANSMISSION TECHNOLOGIES COSTS STUDY

As communities around the world strive to harness renewable energy resources, electricity transmission companies face increasing public opposition to the construction of new overhead lines to connect the new generators. Faced with this challenge, the UK Government has commissioned a comparison study of transmission technologies, and I wish to request your assistance with the provision of information to the study – particularly on the costs associated with transmission circuit construction and lifetime running.

The study will be performed by Parsons Brinckerhoff (PB), an international engineering consultancy, and their work will consider, among other things:

- **The cost of each transmission technology (construction and lifetime),**
- **Impacts from the use of each technology, and**
- **Developing technologies.**

Parsons Brinckerhoff will approach a number of organisations over the coming weeks to request data that will be used to inform the study, and I would be most grateful for any assistance or suggestions you can provide to ensure a supportive response from your organisation.

Although one of the key drivers for this study is the push for renewable energy, any new applications for transmission connections or reinforcements, whether domestic or international, are likely to be faced with a similar challenge. This study has been commissioned to inform all those involved in the design, planning and consenting of new transmission connections. The intention is to publish the results towards the end of the year.

It may be helpful to know that I am writing, with a similar request, to other key transmission technology stakeholders around the world.

If you or your colleagues should have any queries regarding this request, either now or following any approach regarding cost data, please contact Ian Lomas here at the UK Department of Energy and Climate Change (email: ian.lomas@decc.gsi.gov.uk; tel: +44 (0) 300 068 5827).

I thank you in anticipation,

CHARLES HENDRY

Appendix O List of organisations approached

Lists of all organisations approached:

O-1 Information requests for this study

A list of the organisations from whom information was sought for this study.

| Organisation name | Location |
|--|----------------|
| ABB Ltd | UK |
| Allied Insulators | UK |
| Alstom Ltd | UK |
| AMEC | UK |
| Babcock | UK |
| Balfour Beatty PLC | UK |
| Global Marine Systems | UK |
| Mosdorfer CCL Systems Ltd. | UK |
| National Grid | UK |
| Nexans | UK |
| Northern Ireland electricity (NIE) | UK |
| Oxford Archaeology | UK |
| Painter Brothers | UK |
| Preformed Line Products (GB) Limited | UK |
| Prysmian Cables and Systems Ltd | UK |
| Scottish and Southern Energy plc | UK |
| Siemens PLC | UK |
| SP Energy Networks | UK |
| St Gobain Industrial Ceramics | UK |
| Toshiba International (Europe) Ltd | UK |
| ICF (International Cablemakers, Federation) | Austria |
| Midal | Bahrain |
| ENTSO-E | Belgium |
| Europacable E.E.I.G. c/o Cablebel | Belgium |
| Lamifil nv | Belgium |
| Taihan Electric Wire Co., Ltd | China |
| EGE | Czech Republic |
| Dong Energy | Denmark |
| Energinet.dk | Denmark |
| Fingrid Oyj | Finland |
| International Council for Large Electrical Systems (CIGRÉ) | France |
| RTE Réseau de transport d'électricité | France |
| Sediver | France |
| Silec Cable | France |
| EnBW Energie Baden-Württemberg AG | Germany |
| Lapp | Germany |

| Organisation Name | Location |
|---|---------------------|
| NKT Cables | Germany |
| RWE Transportnetz Strom/Amprion | Germany |
| Siem Offshore Contractors | Germany |
| Südkabel | Germany |
| University of Hannover | Germany |
| 50Hertz Transmission GmbH | Germany (N&E) |
| TenneT | Holland |
| Aldabirla | India |
| Sterlite | India |
| Prysmian | Italy |
| Terna SpA | Italy |
| JPower | Japan |
| Viscas | Japan |
| LS Cable & System | Korea |
| Visser & Smit Hanab | Netherlands |
| Statnett | Norway |
| Quintas & Quintas-Condutores Eléctricos, SA | Portugal |
| EirGrid plc | Republic of Ireland |
| Red Eléctrica de España | Spain |
| Svebska Kraftnät | Sweden |
| Brugg | Switzerland |
| MITAS | Turkey |
| AZZ CGIT Systems, Inc. | USA |

Total number of organisations: 59

O-2 Requests for updates to previous submissions

A list of December 2010 stakeholder workshop correspondents who were invited to update any previous submissions.

| Organisation Name | Location |
|---|---------------------|
| CNP | UK |
| CNP in Wales | UK |
| CPRE | UK |
| CPRW | UK |
| Crown Estates | UK |
| DEFRA | UK |
| Dept of Enterprise, Trade and Investment (Northern Ireland) | UK |
| East Anglian Consortium of interested parties | UK |
| Energy UK | UK |
| ENPAA | UK |
| English Heritage | UK |
| Environment Agency | UK |
| HPA | UK |
| ICE | UK |
| IMechE | UK |
| Imperial College | UK |
| Infrastructure Planning Commission | UK |
| Local Government Association | UK |
| Morrison Utility Services | UK |
| NAAONB | UK |
| NFU | UK |
| No Moor Pylons | UK |
| Renewable UK | UK |
| RICS | UK |
| SCNP | UK |
| Scottish Government | UK |
| SHETL | UK |
| SONI | UK |
| Southampton University | UK |
| Strathclyde University | UK |
| UMIST | UK |
| WANPAA | UK |
| Welsh Assembly | UK |
| Wraxall and Failand Parish Council | UK |
| ESB | Republic of Ireland |
| American Superconductor Corps | USA |

Total number of organisations: 36

Of the above 95 organisations approached, substantive responses were received from a total of 25 organisations.

Appendix P December 2010 stakeholder workshop contributions received

A list of electronic files received.

| Filename | Descriptor |
|--|--|
| 1. KEMA – David Davy Femmy – 9Dec2010.pdf | 09Dec10 workshop presentation – KEMA |
| 3a. PBPower Mark Winfield – 9Dec2010.pdf | 09Dec10 workshop presentation – PB / CCI |
| 3b. CPRE- Paul Miner – 9Dec2010.pdf | 09Dec10 workshop presentation – CPRE |
| 3c. No Moor Pylons – Paul Hipwell – 9 Dec2010.pdf | 09Dec10 workshop presentation – No Moor Pylons |
| 3d. Suffolk Amenity – John Foster – 9Dec2010l.pdf | 09Dec10 workshop presentation – Suffolk Amenity |
| 3e. Siemens – Colin Johnston – 9Dec2010.pdf | 09Dec10 workshop presentation – Siemens |
| 3f. HTS presentation 9–12–2010.pdf | 09Dec10 workshop presentation – HTS |
| 3g. NG – Presentation to IET and KEMA 101209.pdf | 09Dec10 workshop presentation – NG |
| 3h. Hugh Pratt IET 8 Dec.pdf | 09Dec10 workshop presentation – IET |
| National Grid – Representation Final Edit 5th Jan 2010 [1].doc | No Moor Pylons – Representation to NG on Hinkley Pt C, Jan”10 |
| 2010 10 13 Poehler.pdf | Siemens undergrounding presentation – cables + GIL |
| Addendum to report of 5th Jan 2010.pdf | Wraxall & Failand – Hinkley C consultation response |
| Call for Evidence Submission AMSC Attachment.pdf | American Superconductor – Superconductor cables for AC and DC. |
| Comments on APL INV4 19.05.07.pdf | PB Power, CCI and MTLA Response to Undergrounding document (APL/INV4) – Beaulieu – Eskdale |
| Entsoe (Europacable) 2010_annual_report_annex7.pdf | Joint Entso Europacable paper |
| Ganderkesee – St. Hulfe.ug-ohl.doc | Cost comparison for 380kV OHL / UGC – Prof. B. R. Oswald (Leibniz University of Hannover, Institute of Electric Power Systems) |
| Wahle – Mecklar.ug-ohl.doc | Cost comparison for 380kV OHL / UGC – Prof. B. R. Oswald (Leibniz University of Hannover, Institute of Electric Power Systems) |
| Gand – St. Hulfe.etc – Prof.Oswald’s comments.doc | Correspondence: Prof. B. R. Oswald to Mr Darke |
| IET_Suffolk_KEMA submission final.doc | Suffolk & Essex amenity groups – Independent Evaluation of the Costs of Undergrounding HV Cables. |

| Filename | Descriptor |
|---|---|
| James Fraser full.pdf | Stirling Before Pylons – Precognition – Tourism and Economic Impact – Stirling Inquiry – Beaully-Denny |
| Joint ENTSO E Europacable Final 8 Dec 2010_4.pdf.pdf | Wrongly named: EirGrid Position on NEPP ASKON Study. Joint Entsoe – Europacable paper filed as: Entsoe (Europaacable) 2010_annual_report_annex7.pdf |
| Ltr to KEMA from M Kinsey 101207 v3_4_.pdf | Letter from Martin Kinsey (NG) |
| Attachment A CBL 275kV.pdf | Capex breakdown (Opex data not filled in) – attachment A to letter from Martin Kinsey (NG) |
| Attachment A CBL 400kV.pdf | Capex breakdown (Opex data not filled in) – attachment A to letter from Martin Kinsey (NG) |
| Attachment A OHL400kV.pdf | Capex breakdown (Opex data not filled in) – attachment A to letter from Martin Kinsey (NG) |
| Nick Hanley.pdf | Prof. Nick Hanley – Stirling Before Pylons, Beaully-Denny Public Inquiry |
| Prysmian wins contract worth more than 90 m euros from INELFE.doc | Prysmian press release – Dec 2010 |
| RE Study on Cable Undergrounding KEMA and others.msg | Email response to KEMA – David MacLehose, Chairman, Scotland Before Pylons |
| Response to beaully to denny 400kV line.pdf.pdf | Highland Council, Cairngorms National Park Authority & Scottish National Heritage – Undergrounding of EHV Transmission Lines (Beaully – Denny) |
| SOE IET undergrounding study 031210.pdf | Costs for HV UGCs in GB – submission by the Campaign to Protect Rural England (CPRE) and the Campaign for National Parks (CNP). |
| sse – 16. Underground as an alternative.pdf | PB Power report, Jan 2007 – Beaully Denny – Use of UGC as an alternative to OHL in Specific Locations |
| Study on Cable Undergrounding KEMA and others.msg | Email response to KEMA – Ronald MacLean, Kiltarlity Community Council (representing Pylon Pressure) |
| UGC Sub to IET Study.pdf | High level assessment of alternative transmission technologies – Meath-Tyrone Interconnection Development – (magazine article?) |
| Under Ground Cables NFU Submission 1 1 10 v2.doc | National Farmers' Union submission to KEMA. |
| Underground high voltage cables – response by the English National Park ec 2010.doc | English National Park Authorities Assoc. |
| UNDERGROUND LINKS BY GAS INSULATED TRANSMISSION LINES.pdf | APSCOM conference 2000 – Underground links by GIL (G.Bazannery, Alstom, France) |

Appendix Q Abbreviations and acronyms

AC: alternating current
ACCC: aluminium composite core conductors
ACSR: aluminium conductor, steel reinforced
CIGRÉ: the International Council on Large Electric Systems
CLF: circuit loading factor
CSC: HVDC current source converter
DC: direct current
DCO: Development Consent Order
DECC: Department of Energy and Climate Change
EHV: extra high voltage
EIA: environmental impact assessment
EPBM: earth pressure balanced machine – one type of TBM
EPC: engineer, procure and construct
GIB: gas insulated busbar
GIL: gas insulated line
GW: gigawatt (one million kW of power)
GZTACSR: Gap-type ZT aluminium alloy conductor, steel reinforced
HVDC: high voltage direct current
IET: Institution of Engineering & Technology
IPC: Infrastructure Planning Commission
km: kilometre
kV: kilovolt – 1000 volts
kW: kilowatt (1000 watts of power)
L6: L6, L8 and L12, are three tower designs currently used by National Grid
LCC: line commutated converter
LF: load factor
LLF: loss load factor
LRMC: long run marginal cost of generation
MI: mass impregnated type transmission cables
MIPU: Major Infrastructure Planning Unit
MVA: megavolt-amperes (a measure of transmission capacity)
MW: megawatt (1000 kW of power)
NSIP: Nationally Significant Infrastructure Projects
OHL: overhead line
OPGW: optical fibre ground wires
PM: project management
PPL: peak power losses
PV: present value
SEC: cable sealing end compound
SRMC: short run marginal cost of generation
TBM: tunnel boring machine
TO: transmission owner
ToR: terms of reference
TSO: transmission system operator
UGC: underground cable
VSC: HVDC voltage source converter
XLPE: cross-linked polyethylene

APPENDIX 3

Approach to the Development of Electricity Transmission Lines

EirGrid (2012)



**Approach to the
Development of Electricity
Transmission Lines**

Approach to the Development of Electricity Transmission Infrastructure

What is EirGrid?

EirGrid is a state-owned company that is responsible for operating and developing the electricity transmission grid in Ireland for the benefit of electricity consumers.

It is putting in place the grid infrastructure required to support competition in the supply of electricity, to assist economic growth and to meet Government targets for the generation of renewable energy.

The Grid

The transmission grid refers to the network of higher-voltage electricity infrastructure on the island, comprising overhead lines, underground cables and substations.

The grid provides the vital link between generators of electricity and its users, ensuring that adequate electricity is provided to power homes, farms and industry.

A grid that is safe, secure, reliable and economical is a key factor in Ireland's ability to attract and retain jobs.

Further development and reinforcement of the grid is required to ensure that all enterprises, from large corporations to small businesses, continue to provide jobs in Ireland.

Over the next 15 to 20 years, there will be major improvements and enhancements to the grid. This is being driven by a number of factors, including

- Harnessing of wind and other renewable energy sources
- Increasing competition in the electricity market
- Reinforcing the grid to meet future demand
- Further interconnection to UK and European grids

Grid25

Grid25 is EirGrid's strategic response to these challenges.

It is a strategy that involves significant improvement to, and reinforcement of, the electricity grid. Over the course of the programme, approximately €3.2 billion will be invested in the planning and development of a broad range of electricity transmission projects throughout the country.

Approach to Developing Large Transmission Projects

The purpose of this document is to provide information as to how we progress our large-scale transmission infrastructure projects over a number of key stages - through the public planning process, to construction and eventual operation.



There are opportunities for engaging with EirGrid throughout these stages, helping inform decisions with regard to the nature, extent and location of our projects.

While this overview is intended to give general guidance to our stakeholders in relation to the development of transmission projects, it must be understood that all projects are different and there is no “one size fits all” process.

As such, while we always seek to develop large-scale projects in line with this approach, in some instances, because of the nature and size of the project, there may be a requirement to deviate from this process. In such circumstances we will explain the reasons for any deviation.

However, our structured framework ensures that planning, environmental and community issues are identified and addressed from the earliest stage, helping EirGrid make fully-informed decisions during the development of a project.

Project Development & Consultation

For our larger projects, EirGrid seeks to follow a structured framework of project development that provides a clear and transparent process to all stakeholders.

We seek to engage with a wide range of stakeholders, including

- Landowners
- Local Communities and the General Public
- Business Organisations
- Statutory Bodies
- Public Representatives

Central to this is ensuring that stakeholders are included in the ongoing development of such projects.

We have identified five key stages of project development - four of which are undertaken prior to the lodgement of an application for statutory consent.

Wayleaving and construction of the grid infrastructure, if consented, is undertaken during the fifth stage.

Consultation and engagement are significant elements of EirGrid’s project development framework. Through all stages of the process, we endeavour to keep the public, and other stakeholders, informed about the project, providing opportunities for input and feedback.

The need for the project is kept under review throughout its progression towards the statutory consent process.

EirGrid's

Project Development Roadmap

The Public's Role in the Development of Projects

The public is an important stakeholder in our projects and can play a crucial role from the earliest stages of project development, for example by making us aware of local constraints that may affect the siting or routeing of a project.

EirGrid always considers this information and endeavours to avoid, limit or mitigate any impact on identified constraints. The final project proposal involves a careful balance between the identified need for the project and technical, environmental, economic and social issues.

EirGrid seeks to engage with people who may be affected by the planned transmission infrastructure - from the earliest stage of project development through to project completion.

Engagement with stakeholders can take a variety of forms, such as open days, meetings and written correspondence, depending on the nature and extent of the project.

As the project develops up to submission of a planning application, the public, local communities, individuals, and others, will have regular opportunities to review and provide input into the issues and options we are considering.

Following submission of a planning application for a proposed development, the public will be provided with an opportunity to make a formal written submission to the decision-making authority – normally An Bord Pleanála.

For some projects, a public Oral Hearing will be held by An Bord Pleanála, which allows a further opportunity for issues to be voiced and addressed.

EirGrid's framework for project development and consultation is set out graphically on the opposite page.

- **Stage One:**
Information Gathering
- **Stage Two:**
Evaluate Options
- **Stage Three:**
Confirm Design
- **Stage Four:**
Prepare Planning Application
- **Stage Five:**
Wayleaving and Construction



Project Development & Consultation Roadmap

| | | | | |
|--|---|--|--|---|
|  <p>STAGE 1</p> <p>Information Gathering</p> <p>Identify Project Study Area</p> <p>Identify environmental & other constraints</p> <p>Identify feasible options (corridor/sites)</p> <p>Publication of Stage 1 Report</p> <p>Pre-application consultation with An Bord Pleanála</p>  <p>1</p> |  <p>STAGE 2</p> <p>Evaluate Options</p> <p>Consideration of all feedback from Stage 1</p> <p>Identification of EirGrid's emerging preferred option (route corridor/site)</p> <p>Identification of indicative line within corridor or site boundary</p> <p>Identify and meet landowners of indicative line/site; initial survey</p> <p>Publication of Stage 2 Report</p> <p>Pre-application consultation with An Bord Pleanála</p>  <p>2</p> |  <p>STAGE 3</p> <p>Confirm Design</p> <p>Consideration of all feedback from Stage 2</p> <p>Conduct environmental studies and surveys</p> <p>Confirmation of design of line/site proposal including construction methodology</p> <p>Ongoing engagement with landowners on preferred line route or site</p> <p>Pre-application consultation with An Bord Pleanála</p>  <p>3</p> |  <p>STAGE 4</p> <p>Prepare Planning Application</p> <p>Complete reports and prepare planning application</p> <p>Preparation of Environmental Impact Statement (EIS) or Environmental Report as required</p> <p>Conclusion of Pre-application consultation with An Bord Pleanála</p> <p>Submit application to An Bord Pleanála</p>  <p>4</p> |  <p>STAGE 5</p> <p>Wayleaving and Construction</p> <p>Preparation of construction plans</p> <p>Serve wayleave notice to landowners and agree access for construction</p> <p>Commence construction</p>  <p>5</p> |
| <p>Public</p> <p>Public and stakeholder consultation on study area and constraints</p> <p>Public and stakeholder consultation on findings of Stage 1 Report</p> | <p>Public</p> <p>Public and stakeholder consultation on findings of Stage 2 Report</p> | <p>Public</p> <p>Ongoing public information</p> | <p>Public</p> <p>Ongoing public information</p> <p>Once application submitted, public can make submissions to An Bord Pleanála including at an oral hearing, if held</p> | <p>Public</p> <p>Ongoing public information</p> <p>Evaluation of Public Consultation process</p> |

Stage One: Information Gathering

STAGE

1

Having identified the technical need for new or enhanced grid infrastructure, EirGrid begins the process of gathering technical, environmental and other information regarding the project.

This stage does not involve making binding decisions regarding the detailed nature, extent and location of the project, but simply gathering as much information as possible to ensure a balanced and robust outcome later in the process.

The focus at this stage is primarily on gathering environmental, social, technical and other information to inform and shape the project.

A broad study area is defined in which the project is likely to be located. Within this study area, environmentally sensitive areas and other constraints are identified and mapped; these include designated or protected landscapes (Special Protection Areas, Special Areas of Conservation, Natural Heritage Areas), protected views, villages, towns and other areas of scenic, amenity, ecological and cultural value.

The principal objective is to avoid these environmental and other constraints.

Public/Stakeholder Input

At this stage of the project we commence engagement with the local communities and the general public within the identified study area of the project. We invite public and

stakeholder comment and feedback on published documentation - regarding the identified study area, the identified constraints therein and on identified potential corridor and site options.

Stage One is the first real opportunity for public input in respect of a project. It is extremely useful for the public to engage with, and provide local knowledge to EirGrid at this early stage, where no decisions have been made, and where there is considerable scope to influence the ongoing development of the project, by identifying what considerations should inform our judgements

Stage One Report

A Stage One Report is prepared by EirGrid, which sets out the need for the project, identifies the broad study area, and presents the information gathered to date. Consultants generally identify a number of identified potential options - indicative corridors or site locations - and what is considered at this stage to be the least constrained of these options to meet the need for the project. We make this report available to the public and other stakeholders, and invite feedback on its content, and issues arising.



STAGE 1

Information Gathering

Identify Project Study Area

Identify environmental & other constraints

Identify feasible options (corridor/sites)

Publication of Stage 1 Report

Pre-application consultation with An Bord Pleanála

Output

- Explanation of project need
- Identification of Study Area
- Identification of environmental and other constraints
- Identification of potential route corridors and/or site locations, including considered least constrained option or options
- Publication of Stage One Report for public consultation and feedback



Public

Public and stakeholder consultation on study area and constraints

Public and stakeholder consultation on findings of Stage 1 Report

Stage Two: Evaluate Options

STAGE

2

Stage Two is where decisions begin to be made and endorsed by EirGrid regarding the detailed nature, extent and location of the proposed development.

We consider all feedback from public and stakeholder consultation obtained during Stage One, and use this, as well as our ongoing technical, environmental and other studies, to make informed decisions regarding potential project options.

This may include modifications to an option, or indeed the identification of other options, to meet the needs of the project. There remains scope for ongoing public and stakeholder input and feedback to influence decisions.

Evaluation of Options

The results of ongoing consultation, together with technical, environmental and other studies carried out to this point, are used to identify what EirGrid considers to comprise the emerging preferred option – generally being the best option from a technical, environmental, community and economic perspective. This ensures a structured approach to determining overall preferences among alternative options.

This stage includes identification of the detail of the project proposal – for example identification of an indicative line route within the emerging preferred corridor, or the indicative site for a substation.

Public /Stakeholder Input

Ongoing public and stakeholder engagement will occur throughout Stage Two in order both to inform the general public about the project and to request further feedback from stakeholders.

This stage also involves identification of, and early engagement with landowners along the identified indicative line route or at the identified indicative substation site.

During Stage Two, we also begin pre-application consultation with An Bord Pleanála (or the relevant planning authority as appropriate) in accordance with the governing Planning and Development Acts.

Stage Two Report

At the end of Stage Two, we will produce a Stage Two Report which summarises feedback received to date. The report identifies any local or wider modifications to potential options and the emerging preferred (least constrained) option following the evaluation process, plus the indicative proposal (line route or substation). This will allow stakeholders to see how and where we have made decisions and the basis upon which we have done so.

As before, we will invite public and stakeholder input and feedback in respect of the Stage Two Report, so it should not be considered that a final decision on these matters has been made at this stage of project development.

STAGE 2

Evaluate Options

Consideration of all feedback from
Stage 1

Identification of EirGrid's emerging preferred option (route corridor/site)

Identification of indicative line within corridor or site boundary

Identify and meet landowners of indicative line/site; initial survey

Publication of
Stage 2 Report

Pre-application consultation with An Bord Pleanála

Public

Public and stakeholder consultation on findings of
Stage 2 Report

Output

- Review and consider all feedback arising in respect of the Stage One Report
- Modify options where appropriate including rationale for making such changes
- Identification of an emerging preferred (least constrained) option, following a multi-criteria evaluation process
- Identification of indicative detailed proposal (line route or substation), following initial landowner engagement and ongoing consultation
- Publication of Stage Two Report for public consultation and feedback



Stage Three: Confirm Design

STAGE

This stage usually occurs in parallel with Stage Four. In this stage, feedback from stakeholders from Stage Two informs the decisions being made by EirGrid with regard to the specific nature, extent and location of the project. EirGrid and its agents will seek to engage with all landowners on the identified proposed route and/or station sites, in order to ensure that any concerns or matters regarding siting of the proposed infrastructure are addressed.

The focus is on land and site-specific technical and environmental surveys and assessment. There is a shift in emphasis from public and stakeholder consultation and feedback to information-giving.

Preferred Option (Route/Site)

As a result of all the information gathering, technical and environmental studies, and public, stakeholder and landowner consultation and engagement that has been carried out up to this stage, the preferred option is identified. We continue to refine the preferred option in consultation with landowners and other stakeholders, and in the context of ongoing studies and assessment, to minimise the potential impact on the receiving human and natural environment. We complete the preliminary design of the proposed development as it is evolving, including identification of the specific location of the alignment, site and associated structures.

Environmental Assessment

We will carry out a comprehensive environmental assessment on the preferred option and will

consult with key statutory and non-statutory stakeholders (primarily government departments, statutory bodies and agencies) on the scope of this assessment. An Environmental Report (ER) or Environmental Impact Statement (EIS) will be submitted as part of the application.

Where a proposed development has the potential to impact upon a designated Natura 2000 site – a site designated under the European Birds and Habitats Directives – we will undertake a screening for Appropriate Assessment in accordance with the requirements of the governing legislation. Depending on the results of this screening, we will prepare a Natura Impact Statement (NIS) which will also be submitted as part of the application.

Public/Stakeholder Input

We continue to update our stakeholders during the process of confirming the design of the proposed development. In particular, we will continue to engage with landowners who are directly affected by the project, as well as with the relevant planning authority. The public and stakeholders will continue to be informed of project progress, and further feedback and input in respect of the project is always welcomed. We will continue to publish factual reports and updates concerning the project on our project website (www.eirgrid.com/projects).

However, at this stage of project development, where there is less opportunity to influence decisions, the emphasis is more on sharing information with the public and stakeholders, for example on project progress, than on seeking new public and stakeholder feedback and input.



STAGE 3

Confirm Design

Consideration of all feedback from **Stage 2**

Conduct environmental studies and surveys

Confirmation of design of line/site proposal including construction methodology

Ongoing engagement with landowners on preferred line route or site

Pre-application consultation with An Bord Pleanála

Output

- Identify preferred project option and the nature, extent and location of proposed development
- Undertake environmental assessment of proposed development (including Appropriate Assessment if required), in accordance with Irish legislation and European Directives
- Ongoing public and stakeholder involvement, primarily by means of information-giving
- Ongoing landowner engagement



Public

Ongoing public information

Stage Four: Prepare Planning Application

STAGE

4

Stage Four usually occurs in parallel with Stage Three. In this stage, we are preparing the documents, maps and drawings, and other particulars to submit as a planning application.

Once the application has been submitted, the project is in a formal application process. The consenting authority (either An Bord Pleanála or the relevant planning authority, depending on the nature of the application, as confirmed by An Bord Pleanála) will facilitate public input, initially by means of written submission.

At its discretion, An Bord Pleanála may hold an oral hearing in respect of the proposed development. As such, the application process also ensures considerable public participation.

Stage Four will conclude with a decision by the consenting authority in respect of the proposed development.

Public and Stakeholder Consultation

In addition to any informal update or information provided by EirGrid, the public will be formally notified when the application is lodged through a public notice in the newspaper.

The project website will also be updated once the planning application is lodged and we will direct

the public to where they can make a submission to the consenting authority during its formal public consultation period.

If the application is submitted to An Bord Pleanála, it will require EirGrid to provide a dedicated website, containing the full planning application, to allow the public and other parties to view the application online.

Oral Hearing

At the discretion of An Bord Pleanála, an oral hearing will be undertaken under its chairmanship in the region in which the project is proposed. We will fully engage in any oral hearing and will provide all relevant information to allow the Bord to make an informed decision.

Planning Decision

On concluding the planning process the consenting authority will issue its decision and will either issue one of three decisions.

1. Decision to Grant Permission.
2. Decision to Grant Permission, subject to conditions which have to be complied with.
3. Decision not to Grant Permission.

STAGE 4

Prepare Planning Application

Complete reports and prepare planning application

Preparation of Environmental Impact Statement (EIS) or Environmental Report as required

Conclusion of Pre-application consultation with An Bord Pleanála

Submit application to An Bord Pleanála

Output

- Preparation of application documents, including environmental assessment
- Submission of application to the appropriate planning authority or An Bord Pleanála
- Publication of application documents on a dedicated applications website
- Updating of separate EirGrid project website
- Ongoing input throughout applications process as required
- Ultimate decision of An Bord Pleanála or Planning Authority



Public

Ongoing public information

Public can make submissions to An Bord Pleanála once application submitted

Stage Five: Wayleaving and Construction

STAGE

5

Assuming that an application for a proposed development has been successful and has been consented, construction plans will be developed. Wayleave notices will be issued to landowners for access to land to enable construction to proceed.

Subsequent to obtaining landowner permission, EirGrid will inform ESB Networks of the successful issuance of wayleaves. ESB Networks will undertake the actual construction of the transmission infrastructure and the resulting energisation of the project.

Public and Stakeholder Consultation

We will continue to engage with landowners who are directly affected by the project with a view to agreeing access for constructing the permitted development.



5

STAGE 5

Wayleaving and Construction

Preparation of construction plans

Serve wayleave notice to landowners and agree access for construction

Commence construction

Output

- Implementation of permitted development
- Preparation of detailed construction plans
- Construction of the permitted development
- Energisation and operation of the new transmission infrastructure
- Ongoing communications and liaison with landowners, and as appropriate, local communities and the general public



Public

Ongoing public information

Evaluation of Public Consultation process

EirGrid is a wholly owned State company which is responsible for operating and developing the electricity transmission grid in Ireland. The electricity grid or “grid” is the backbone of the electricity network in Ireland. The grid provides the vital link between generators of electricity and its users. The grid ensures that adequate electricity is provided, to all users in Ireland, to power homes, farms and industry.

We seek public input in respect of projects, including local knowledge views as to what considerations should inform our judgements, based on what is considered to be important to local stakeholders.

Major changes to Ireland’s electricity industry will be driven by the harnessing of wind and other renewable energy sources, increased competition in the supply of electricity, a requirement to reinforce the existing grid to meet anticipated future demand and further interconnection to UK and European grids.



EirGrid plc
The Oval
160 Shelbourne Road
Ballsbridge
Dublin 4

Tel: +353 (0)1 6771700
Fax: +353 (0)1 661 5375

www.eirgrid.com

APPENDIX 4

EU Law and Policy

[in chronological order]

DRAFT

DRAFT

| Date of Adoption or Publication | Document Title |
|---|--|
| Relevant EU Law and Policy includes: | |
| 19 December 1996 | Directive 96/92/EC of the European Parliament and of the Council concerning common rules for the internal market in electricity |
| 27 September 2001 | Directive 2001/77/EC of the European Parliament and of the Council on the promotion of electricity produced from renewable energy sources in the internal electricity market |
| 8 May 2003 | Directive 2003/30/EC of the European Parliament and of the Council on the promotion of the use of biofuels or other renewable fuels for transport |
| 26 June 2003 | Directive 2003/54/EC of the European Parliament and of the Council concerning common rules for the internal market in electricity and repealing Directive 96/92/EC |
| 18 November 2004 | Department of Communications, Marine and Natural Resources (DCMNR) and the Department of Enterprise, Trade and Investment (DETI), and the two regulatory authorities - Commission for Energy Regulation (CER) and the Northern Ireland Authority for Energy Regulation (NIAER) " <i>All-Island Energy Market Framework – A Development Framework</i> " |
| 18 January 2006 | Directive 2005/89/EC of the European Parliament and of the Council concerning measures to safeguard security of electricity supply and infrastructure investment |
| 8 March 2006 | <i>Green Paper-A European Strategy for Sustainable, Competitive and Secure Energy</i> |
| 6 September 2006 | Directive 2006/1364/EC on trans-border European energy network infrastructure |
| 10 January 2007 | Communication from the Commission to the European Council and the European Parliament <i>An Energy Policy for Europe</i> [COM (2007) 1 final] |
| 23 April 2009 | Directive 2009/28/EC of the European Parliament and of the Council National Renewable Energy Action Plans on the promotion of the use of energy from renewable sources and amending and subsequently repealing Directives 2001/77/EC and 2003/30/EC |
| 13 July 2009 | Directive 2009/72/EC of the European Parliament and of the Council concerning common rules for the internal market in electricity and repealing Directive 2003/54/EC |
| 13 July 2009 | Directive 2009/73/EC of the European Parliament and of the Council concerning common rules for the internal market in natural gas and repealing Directive 2003/55/EC |
| 30 March 2010 | Treaty on the Functioning of the European Union (TFEU) |
| 10 November 2010 | Communication from the Commission to the European Parliament, the Council, the European Economic and Social Committee and the Committee of the Regions " <i>Energy 2020 A Strategy for competitive, sustainable and secure energy</i> " [COM(2010) 639 final] |
| 17 November 2010 | European Commission issued the Communication Energy Infrastructure Priorities for 2020 and beyond – A Blueprint for an Integrated European Energy network [COM/2010/1395] |
| 8 March 2011 | Communication from the Commission to the European Parliament, the Council, the European Economic and Social Committee and the Committee of the Regions " <i>Energy Efficiency Plan 2011</i> " [COM/2011/109 final] |
| 19 November 2011 | European Commission Report " <i>Connecting Europe – The Energy Infrastructure of Tomorrow</i> " |
| 15 December 2011 | Communication from the Commission to the European Parliament, the Council, the European Economic and Social Committee and the Committee of the Regions " <i>Energy Roadmap 2050</i> " [COM/2011/0885 final] |

| | |
|------------------|---|
| 6 June 2012 | Communication from the Commission to the European Parliament, the Council, the European Economic and Social Committee and the Committee of the Regions <i>“Renewable Energy: A Major Player in the European Energy Market”</i> [COM/2012/0271 final] |
| 15 November 2012 | Communication from the Commission to the European Parliament, the Council, the European Economic and Social Committee and the Committee of the Regions <i>“Making the Internal Energy Market Work”</i> [COM/2012/0663 final] |
| 28 November 2012 | Report from the Commission to the European Parliament, the Council, the European Economic and Social Committee and the Committee of the Regions <i>“State of the Single Market Integration 2013 -Contribution to the Annual Growth Survey 2013 “</i> |
| 27 March 2013 | Green Paper <i>“A 2030 Framework for Climate and Energy Policies”</i> [COM (2013) 169 final] |
| 27 March 2013 | Report from the Commission to the European Parliament, the Council, the European Economic and Social Committee and the Committee of the Regions <i>“Renewable Energy Progress Report”</i> (under the framework of the Directive 2009/28/EC) |
| 17 April 2013 | Regulation (EU) No 347/2013 of the European Parliament and of the Council, on guidelines for trans-European energy infrastructure and repealing Decision No 1364/2006/EC and amending Regulations (EC) No 713/2009, (EC) No 714/2009 and (EC) No 715/2009 |
| 24 July 2013 | European Commission (July 2013) Streamlining environmental assessments procedures for energy infrastructure Projects of Common Interest (PCIs) |
| 14 October 2013 | European Commission Delegated Regulation 1391/2013, issued on 14 October 2013, which identified the projects to be part of the first EU list of projects of common interest (PCIs) and described the process which led to the identification of such projects. |
| 16 April 2014 | Directive 2014/52/EU of 16th April 2014 amends Directive 2011/92/EU. The amendments are intended to address the new policy, legal and technical context for assessing the potential effects of projects on the environment and correct identified and persistent shortcomings. Member States have until 16 May 2017 to transpose the Directive into national legislation and apply the new rules. |

APPENDIX 5

Policy Review of County Development Plans

DRAFT

MONAGHAN COUNTY DEVELOPMENT PLAN 2013 - 2019

DRAFT

| MONAGHAN COUNTY DEVELOPMENT PLAN 2013-2019 | | | |
|--|---------------------------------|---|--|
| POLICY TOPIC | POLICY | POLICY OBJECTIVE | |
| Vision Statement | Vision | <i>"Monaghan is an inclusive, outward-looking, progressive county, which enjoys a diverse, vibrant economy, a sustainable environment and a high quality of life for all" (p. 25)</i> | |
| Vision Statement | Development Plan Strategic Aims | <p>The Plan sets out the following Strategic Aims:</p> <ul style="list-style-type: none"> • <i>"Sustainably develop the full potential of each part of the County in economic, social and environmental terms.</i> • <i>Sustain traditional settlement patterns, while developing the role and function of each town, village and settlement throughout the county.</i> • <i>Developing Monaghan Town as a hub town with a target population of 9,000 by 2020.</i> • <i>Developing Carrickmacross, Castleblayney, Clones and Ballybay towns as attractive, viable services centres to meet the needs of their surrounding hinterlands.</i> • <i>Sustaining the vitality of the villages and settlements throughout the county as sustainable service centres to meet the needs of rural communities.</i> • <i>Improve transport linkages and communications between County Monaghan and its neighbouring counties, and to capitalise on the county's strategic spatial location.</i> • <i>Support balanced economic development throughout the county by delivering improved infrastructure and services.</i> • <i>Preserve the environmental quality of the natural and built environment in rural and urban areas.</i> • <i>Improve the quality of life of all who live and work in the county."</i> (p. 26) | |
| Environment Heritage | & Geological Heritage | <p>Policies:</p> <p>GHP 1. <i>To protect geological heritage sites within the county from inappropriate development.</i></p> <p>GHP 2. <i>To protect geological NHAs / pNHAs as they become designated and notified to the Council, during the lifetime of this Plan.</i></p> <p>GHP 3. <i>Notify the Geological Survey of Ireland in advance of any significant ground excavations".</i> (p. 56)</p> | |
| Environment Heritage | & Landscape Assessment | Character | <p>Objectives:</p> <p>LPO 1. <i>Sustain, conserve, manage and enhance the landscape diversity, character and quality of the County for the</i></p> |

| MONAGHAN COUNTY DEVELOPMENT PLAN 2013-2019 | | |
|--|---|--|
| POLICY TOPIC | POLICY | POLICY OBJECTIVE |
| | | <p>benefits of current and future generations.</p> <p>LPO 2. Zone important landscape features and elevated lands within settlements as Landscape Protection / Conservation Areas, to ensure that developments do not detrimentally impact on the amenity of the landscape or on the natural setting of settlements” (p.58).</p> <p>Policies:</p> <p>“LPP 1 Ensure the preservation and uniqueness of the county’s landscape by having regard to the character, value and sensitivity of landscape as identified in the County Monaghan Landscape Character Assessment, August 2008 (or any subsequent versions) when determining a planning application.</p> <p>LPP 2 Protect the landscapes and natural environments of the county by ensuring that any new developments in designated sensitive rural landscapes do not detrimentally impact on the character, integrity, distinctiveness or scenic value of the area.</p> <p>LPP 3 Development which fails to appropriately integrate into the landscape with due regard to visual impact, landscape amenity, the protection of skylines, amenities such as lakes, designated walkways, heritage sites and recreational and tourist facilities shall be resisted.” (p. 58)</p> |
| Environment Heritage | & Amenity Areas of Primary Amenity Value | <p>The Plan states that:</p> <p>“County Monaghan has two principle areas of outstanding landscape quality which require protection from insensitive and inappropriate development. They are designated as Areas of Primary Amenity Value.</p> <ol style="list-style-type: none"> 1. Lough Muckno and its Environs 2. Slíabh Beagh and Bragan Mountain Areas <p>Development will only be permitted in these areas in exceptional circumstances where the integrity of the landscape is not threatened. Any intrusive development, where such development would normally be exempt, is removed from the category of exempted development.</p> <p>Whilst there is limited potential to accommodate sensitively designed development in these areas, any proposal which would threaten the existing landscape, landform, flora, fauna, scenic or environmental characteristics that distinguish these areas will be resisted. An Environmental Impact Assessment must accompany all planning applications, where the Planning Authority considers that new development may have a detrimental environmental impact on the area.</p> <p>Tree planting and felling will be strictly controlled to ensure minimal disturbance of the landscape and environment”.</p> <p>(p.59-60)</p> |

| MONAGHAN COUNTY DEVELOPMENT PLAN 2013-2019 | | |
|--|--|--|
| POLICY TOPIC | POLICY | POLICY OBJECTIVE |
| | | <p>The Plan contains the following Policies:</p> <p>PAP 1 Limit development in Areas of Primary Amenity Value to those where the applicant has proven to the satisfaction of the Planning Authority that the proposed development would not threaten the integrity of these areas.</p> <p>PAP 2 Development within primary amenity areas that would normally be considered 'exempt development', and which would in the opinion of the planning authority detrimentally impact on the visual amenity of the area, will be removed from that category of exempted development." (p. 60)</p> |
| Environment & Heritage | Amenity Areas of Secondary Amenity Value | <p>The Plan states that:</p> <p><i>".....County Monaghan has a number of other sensitive landforms and amenity areas that require protection from inappropriate development. These areas are designated as Areas of Secondary Amenity Value, by reason of their landscape quality and recreational potential. These areas have significant potential to develop as sustainable community, recreational or tourism centres. Whilst these areas are to be kept free from intrusive development, sensitively designed proposals on unobtrusive sites and compatible amenity may be accommodated. The areas identified in Appendix 1 are designated as Secondary Amenity Areas."</i> (p. 60)</p> <p>The table in Appendix 1 of the Plan lists the Areas of Secondary Amenity Value as follows:</p> <ul style="list-style-type: none"> • Emy Lough and Environs • Blackwater River Valley • Mountain Water River Valley • Mullyash Mountain • Ulster Canal and Environs • Rossmore Park and Environs • Castleshane Woods and Environs • Billy Fox Memorial Park and Environs • Annaghmakerrig Lake, Woodlands and Environs • Dartry Demesne and Environs • Dromore River and Lake System • Lough Major and Environs |

| MONAGHAN COUNTY DEVELOPMENT PLAN 2013-2019 | | |
|--|-----------------------------------|---|
| POLICY TOPIC | POLICY | POLICY OBJECTIVE |
| | | <ul style="list-style-type: none"> • Hollywood Lake • Lisanisk Lake • Lough Naglack • Rahans Lake <p>The Plan contains the following policies:</p> <p>SAP1 Limit development within Areas of Secondary Amenity Value to compatible amenity developments on unobtrusive sites.</p> <p>SAP2 Tree planting and felling will be strictly controlled to ensure minimal disturbance of landscape and the environment.” (p. 60)</p> |
| Environment Heritage & | Areas of Visual Amenity | <p>AVP 1 Protect the views from scenic routes listed in Appendix 2, Scenic Routes. Development will be strictly controlled along these routes and no development will be permitted that will detrimentally impact on the visual character or amenity of these views. Particular emphasis will be placed on the preservation of views of lakes, rivers, unspoilt landscape or views of historical, heritage and/or cultural interest.</p> <p>AVP 2 Protect the scenic quality of lakes by prohibiting development which is located between a public road and a lake, where the development would interrupt a view of the lake, or detrimentally impact on the setting of that lake. Development may be permitted between a road and a lakeshore where the development is screened from the lake by existing topography or vegetation.</p> <p>An exception to this policy may include short term let holiday accommodation or recreational development where a specific need has been established. The design, scale and setting of development granted under this exception should reflect the site’s sensitive location.</p> <p>Such prohibition will also apply to high open landscape overlooking lakes and waterways, where such development would detrimentally impact on the setting of that lake or waterway.</p> <p>For the purpose of this policy a lake is considered to be a permanent (i.e. non seasonal) water feature in excess of 1 hectare.” (p. 61)</p> |
| Environment Heritage & | Biodiversity and Natural Heritage | <p>The Plan contains the following objectives:</p> <p>BDO 1 To protect, enhance and promote for current and future generations the rich biodiversity of County Monaghan.</p> <p>BDO 2 To designate County Biodiversity Sites within the lifetime of the Plan and to protect the ecological integrity of</p> |

| MONAGHAN COUNTY DEVELOPMENT PLAN 2013-2019 | | |
|--|---------------------|---|
| POLICY TOPIC | POLICY | POLICY OBJECTIVE |
| | | <p>these sites.</p> <p>BDO 3 Protect and enhance, plant and animal species and their habitats, which have been identified under the EU Habitats Directive, EU Birds Directive, the Wildlife Act and the Flora Protection Order.</p> <p>BDO 4 Promote the retention, management and development of wildlife features such as hedgerows, riparian corridors, wetlands and other semi natural features that are essential for the migration, dispersal and genetic exchange of wild species. In exceptional circumstances, where it has been demonstrated to the satisfaction of the Planning Authority that the removal of habitats of local biodiversity value cannot be avoided, equal quantities of habitat must be reinstated. Details of which must be agreed with the planning authority.</p> <p>BDO 5 Ensure that development proposals do not lead to the spread of invasive species. Ensure that landscaping proposals do not include invasive species.</p> <p>BDO 6 Implement the actions of the Monaghan Biodiversity Action Plan 2009-2014 and any subsequent version.</p> <p>BDO 7 Ensure that the Council, in the performance of its functions, takes account of the Ramsar Convention principle of conservation and wise use of wetlands as a contribution towards achieving sustainable development.” (p.64)</p> <p>The Plan sets out the following policy:</p> <p>“BDP 1 The Council will resist any development that may have a negative impact upon Biodiversity and Natural Heritage”. (p.64)</p> |
| Environment & Heritage | Trees and Hedgerows | <p>Objectives:</p> <p>“THO 2 Employ where appropriate, Tree Preservation Orders to protect important trees, groups of trees or woodlands of special amenity value”. (p. 65)</p> <p>Policies:</p> <p>“THP 1 Protect trees and hedgerows from development that would impact adversely upon them. Development proposals which necessitate the removal of extensive amounts of trees and hedgerows should be avoided and transplanting of existing trees and hedgerows should be employed where appropriate.</p> <p>THP 2 Preserve trees and/or groups of trees that form significant features in the landscape or have particular importance in setting the landscape character of an area or which contribute to the biodiversity of the area (Appendix 3, Trees of Special Amenity Value).</p> <p>THP 3 Ensure that existing mature trees, woodlands and hedgerows are, as far as practicable, preserved and incorporated into any new developments or where removal is unavoidable, compensatory planting of at least equal</p> |

| MONAGHAN COUNTY DEVELOPMENT PLAN 2013-2019 | | |
|--|------------------------------------|---|
| POLICY TOPIC | POLICY | POLICY OBJECTIVE |
| | | <p>amounts of native trees and shrubs should be undertaken.</p> <p>THP 4 Where trees and/or hedgerows along a public road are set back/removed in order to provide sightlines for a new access, a new hedge containing native species will be planted behind sight lines.” (p. 65)</p> |
| Environment & Heritage | Habitat Designation and Protection | <p>Policy for Sliabh Beagh Conservation Management:</p> <p>“SBP 1 To implement the objectives of the Sliabh Beagh Conservation Management Plan”. (p. 67)</p> <p>Policies for the Protection of Designated Sites:</p> <p>“DSP 1 Strictly protect areas designated or proposed to be designated as Natura 2000 sites (listed in Appendix 4). Development within or adjacent to these areas will only be permitted where it has been clearly demonstrated to the satisfaction of the planning authority that such development will have no significant adverse effects on the conservation objectives or integrity of these sites in accordance with the Habitats Directive.</p> <p>DSP 2 Protect the NHA and pNHAs, listed in Appendix 4 by resisting development which would detrimentally impact on the conservation status or integrity of those sites. Development in these areas will only be permitted where it has been clearly demonstrated to the satisfaction of the Planning Authority that any such development will have no significant adverse effects on the integrity of these sites”. (p. 67)</p> <p>Objective for Wetlands:</p> <p>“WLO 1 To protect existing wetlands from destruction, infilling, fragmentation and degradation.” (p. 68)</p> <p>Policy for Wetlands:</p> <p>“WLP 1 Development that would destroy, fragment and degrade wetlands will be resisted”. (p. 68)</p> <p>Objective for Appropriate Assessment:</p> <p>“AAO 1 Ensure that the Council in the performance of its functions takes account of the Habitats and Birds Directives.” (p. 71)</p> <p>Policies for Appropriate Assessment:</p> <p>“AAP 1 Ensure that all plans and projects in the County, not directly connected with or necessary to the management of a Natura 2000 site, but likely to have a significant effect, either directly or indirectly, on a Natura 2000 site, either alone or in combination with other plans or projects, are subject to Appropriate Assessment Screening in accordance with Article 6 of the Habitats Directive.</p> |

| MONAGHAN COUNTY DEVELOPMENT PLAN 2013-2019 | | |
|--|-----------------------------|---|
| POLICY TOPIC | POLICY | POLICY OBJECTIVE |
| | | <p>AAP 2 The Planning Authority shall fully implement the DEHLG guidance <i>Appropriate Assessment of Plans and Projects in Ireland (2009)</i> and any subsequent versions, when assessing plans and projects likely to have significant effects on a Natura 2000 site.</p> <p>AAP 3 All planning applications for development within, adjacent to, or with the potential to affect a Natura 2000 site must be accompanied with a Natura Impact Statement in accordance with the Habitats Directive. Natura Impact Statements submitted in support of proposals for development must be carried out by appropriately qualified professionals with any necessary survey work taking place in appropriate seasons.</p> <p>AAP 4 Consult the National Parks and Wildlife Service (NPWS), the Department of the Arts, Heritage and the Gaeltacht (DAHG), the Heritage Council and An Taisce when considering plans or projects which are likely to affect Natura 2000 sites.</p> <p>AAP 5 All plans within, adjacent to, or with the potential to affect a Natura 2000 site must be accompanied with a Natura Impact Report in accordance with the Habitats Directive”. (p. 71)</p> |
| Environment & Heritage | Water Resources and Quality | <p>Objectives for Protection of Water:</p> <p>WPO 1 Protect and improve County Monaghan’s water resources.</p> <p>WPO 2 All first order streams containing areas of stony/gravel bed and higher order streams are considered vulnerable and require protection in terms of water quality and physical structure. Such streams shall be identified and or the connectivity to such streams shall be identified in the water protection plan referred to in Policy WPP 5. All discharges to such streams should be assessed with a view to minimisation of risk to waters.</p> <p>WPO 3 Provide information on environmental issues, promote engagement between developers and regulators, promote sustainable development and encourage a high standard of environmental protection. The precautionary principle will be applied where a significant risk to the environment exists.</p> <p>WPO 4 Protect rivers, streams and other water courses and maintain them in a state capable of providing and sustaining suitable habitats for flora and fauna, and where necessary designate riparian zone protection areas.</p> <p>WPO 5 Achieve ‘good status’ in waterbodies and prevent deterioration of existing water quality status in all waterbodies in accordance with the Water Framework Directive” (p. 75)</p> <p>Policies for Protection of Water:</p> <p>WPP 1 In assessing applications for developments the Council will consider the impact on the quality of surface waters and will have regard to targets and measures set out in the Neagh Bann and North Western International River Basin Management Plans and where appropriate the Blackwater, Glyde, Fane, Woodford and Erne East Water Management Unit Action Plans.</p> |

| MONAGHAN COUNTY DEVELOPMENT PLAN 2013-2019 | | |
|--|--------|--|
| POLICY TOPIC | POLICY | POLICY OBJECTIVE |
| | | <p>WPP 2 In assessing applications for development, the planning authority shall ensure compliance with the European Communities Environmental Objectives (Surface Waters) Regulations, 2009 (S.I. No 272 of 2009) and the European Communities Environmental Objectives (Groundwater) Regulations, 2010 (S.I. No. 9 of 2010).</p> <p>WPP 3 Protect known and potential groundwater reserves in the county. In assessing applications for developments the planning authority will consider the impact on the quality of water reserves and will have regard to the recommended approach in the Groundwater Protection Scheme for County Monaghan. The employment of the methodology identified in the Groundwater Protection Scheme for County Monaghan (available at www.gsi.ie) and Guidance on the Authorisation of Discharges to Groundwater (available at www.epa.ie) will be required where appropriate.</p> <p>WPP 5 Require submission of a water protection plan and detailed site drainage plans with all planning applications. Maps of sensitive areas and waters and a Water Protection Plan Checklist (Appendix 13) will assist in the preparation of plans at application stage.</p> <p>WPP 6 Prevent further degradation of habitat by the promotion of riparian corridors and the prevention of any in stream works, or culverting of waterways unless in accordance with Inland Fisheries Ireland (IFI) guidance document Requirements for the Protection of Fishery Habitat During Construction and Development Works at River Sites. The IFI should be consulted prior to the submission of any plans involving works close to waterways.</p> <p>WPP 7 No development shall be permitted within 200 metres of any lake that is the source of a water supply, where that development has the potential to pollute the lake.</p> <p>WPP 9 Details of land spreading arrangements of manures or sludge arising from industrial or intensive agricultural development shall be submitted to the planning authority with all planning applications.</p> <p>WPP 10 Development within the vicinity of groundwater or surface water dependant Natura 2000 sites (Kilroosky Lough Cluster SAC) will not be permitted where there is potential for a likely significant impact upon the groundwater or surface water supply to the Natura 2000 site. Where appropriate, the applicant to demonstrate with hydrogeological evidence, that the proposed development will not adversely affect the quality or quantity of groundwater or surface water supply to the Natura 2000 sites.</p> <p>WPP 11 Development which would have an unacceptable impact on the water environment, including surface water and groundwater quality and quantity, river corridors and associated wetlands will not be permitted.</p> <p>WPP 12 Floodplains and riparian corridors will be maintained free from development to provide flood retention features within these areas.” (p. 76-78)</p> |

| MONAGHAN COUNTY DEVELOPMENT PLAN 2013-2019 | | |
|--|---|---|
| POLICY TOPIC | POLICY | POLICY OBJECTIVE |
| Environment Heritage & | Green Infrastructure | <p>Objectives:</p> <p>GIO 1 Develop a Green Infrastructure Strategy within County Monaghan during the life-time of the Development Plan, ensuring the protection of County Monaghan's Natura 2000 sites is central to this strategy. This Strategy shall be prepared in full compliance with the requirements of Strategic Environmental Assessment (SEA) and Habitats Directives.</p> <p>GIO 2 Seek a net gain in green infrastructure through the protection and enhancement of existing assets, through the provision of new green infrastructure where appropriate, and in consultation with stakeholders, as an integral part of the planning process.</p> <p>GIO 3 Provide attractive and safe routes linking key green space sites, parks and open spaces, cultural and heritage assets as an integral part of infrastructure provision where feasible and appropriate". (p. 82)</p> <p>Policy:</p> <p>GIP 1 Resist development that would damage, degrade, fragment or prejudice the County's strategic green infrastructure network". (p.80)</p> |
| Environment Heritage & | Architectural and Built Heritage | <p>Objectives:</p> <p>ABO 1 To secure the preservation of all sites and features of architectural and historical interest.</p> <p>Policy:</p> <p>ABP 2 In securing the conservation and preservation of built heritage, the planning authority will have regard to the advice and recommendations of the Department of the Arts, Heritage and the Gaeltacht, both in respect of whether or not to grant planning permission and in respect of the conditions to which the permission, if granted, should be subject". (p. 84)</p> |
| Environment Heritage & | Record of Protected Structures Policies | <p>Objective:</p> <p>PSO 1 Protect and/or conserve, as appropriate, all structures included in the Register of Protected Structures set out in Appendix 5." (p. 85)</p> <p>Policy:</p> <p>PSP 4 Resist development which is likely to adversely affect the setting of, designed landscape features of, or designed views or vistas to or from a protected structure, where the setting is considered of importance." (p. 86)</p> |

| MONAGHAN COUNTY DEVELOPMENT PLAN 2013-2019 | | |
|--|-------------------------|--|
| POLICY TOPIC | POLICY | POLICY OBJECTIVE |
| Environment & Heritage | Archaeological Heritage | <p>Objectives:</p> <p><i>“AHO 1 Protect the monuments and places listed in Appendix 6 (and any additions by the National Monuments Service) to ensure that the importance of the setting of the monument or site, and its interrelationship with other archaeological sites is not materially injured, and that no development will impinge directly on any monument or site or on any associated archaeological material.</i></p> <p><i>AHO 2 Co-operate with the Department of Arts, Heritage and the Gaeltacht and all other relevant bodies in providing maximum protection to any monument or place of archaeological importance not listed in Appendix 6 and discovered within the lifetime of this plan” (p. 89)</i></p> <p>Policies:</p> <p><i>“AHP 1 Safeguard the value of archaeological sites listed in the Record of Monuments and Places in Appendix 6 by strictly controlling any development that may prove injurious to the historical, archaeological, scientific, setting and/or educational value of any monument or place.</i></p> <p><i>AHP 2 To ensure that development in the vicinity of a site of archaeological interest shall not be detrimental to the character of the archaeological site or its setting by reason of its location, scale, bulk, detailing or visual impact.</i></p> <p><i>AHP 3 When considering development in the vicinity of archaeological monuments, the planning authority will aim to achieve a satisfactory buffer area between the development and the monument in order to ensure the preservation and enhancement of the amenity associated with the monument. This should be achieved in consultation with the Department of the Arts, Heritage and Gaeltacht. The areas of the monument and buffer areas should not be included within the required open space area of any development but should be in addition to such requirements.</i></p> <p><i>AHP 4 In securing the conservation and preservation of built heritage, the planning authority will have regard to the advice and recommendations of the Department of the Arts, Heritage and the Gaeltacht, both in respect of whether or not to grant planning permission and in respect of the conditions to which the development, if granted, should be subject.</i></p> <p><i>AHP 5 When considering development in the vicinity of all archaeological monuments, the planning authority will require the preparation and submission of an archaeological assessment, detailing the potential impact of any development on both upstanding and buried structures and deposits. The report shall also include a visual assessment to ensure adequate consideration of any potential visual impact and should define the buffer area or area contiguous with the monument which will preserve the setting and visual amenity of the site. Where a monument or place included in the Record of Monument and Places lies within the open space requirement for a development, a conservation plan for that monument should be requested as part of the landscape plan for that proposed open space.</i></p> |

| MONAGHAN COUNTY DEVELOPMENT PLAN 2013-2019 | | |
|--|--|--|
| POLICY TOPIC | POLICY | POLICY OBJECTIVE |
| | | <p>AHP 6 Require archaeological investigations at pre-approval stage where development is proposed on areas of archaeological potential.</p> <p>AHP 7 Consider archaeological value when considering proposals for public service schemes, electricity, sewage, telecommunications, water supply and proposed road schemes where these impinge on or are in close proximity to Recorded Monuments and Places and/or Areas of Urban Archaeology. Where any subsurface archaeological features are discovered during the course of infrastructural/development works, these features should be preserved in-situ or preserved by record.</p> <p>AHP 8 Have regard to Historic Landscape Character Assessments in assessing planning applications.” (p. 89-90)</p> |
| Environment Heritage | & Noise | <p>Policy:</p> <p>“NCP 1 The Planning Authority will seek to protect the amenity of individuals, dwellings, businesses, community facilities and other existing development, when assessing proposals for development that are likely to generate significant levels of noise”. (p. 91)</p> |
| Environment Heritage | & Air | <p>Objectives:</p> <p>“AQO 2 Promote the retention of trees, hedgerows and other vegetation, and encourage forestation and tree planting as a means of air purification and filtering.” (p. 92)</p> <p>Polices:</p> <p>“AQP 1 In conjunction with the EPA, ensure that all existing and proposed developments are operated in a manner that does not permit them to contribute to any deterioration in air quality.” (p. 92)</p> |
| Economic Activity | Agriculture | <p>Objectives:</p> <p>“AGO 3 Protect high quality agricultural land within the county” (p. 103)</p> |
| Economic Activity | Forestry | <p>Objectives:</p> <p>“FYO 3 Protect natural waters, wildlife habitats, conservation areas, heritage areas, archaeological sites and artefacts within forest sites and nature designations from pollution or injury”. (p. 105)</p> |
| Economic Activity | Climate Change, Energy and Renewable Resources | <p>Objectives for Climate Change:</p> <p>“CCO 1 To implement where relevant and appropriate the National Climate Change Strategy 2007-2012 and any subsequent strategies.</p> |

| MONAGHAN COUNTY DEVELOPMENT PLAN 2013-2019 | | |
|--|--------------------------------|--|
| POLICY TOPIC | POLICY | POLICY OBJECTIVE |
| | | <p>CCO 2 To facilitate measures which seek to establish a low carbon economy and society by 2020.</p> <p>CCO 3 To facilitate measures which seek to reduce emissions of greenhouse gases.” (p. 106)</p> <p>Objectives for Energy and Renewable Resources:</p> <p>“ERO 1 Ensure that all plans and projects relating to energy and renewable resources development are subject to policies AAP1-AAP5 contained within Chapter 4, Environment and Heritage, of the Monaghan County Development Plan 2013-2019.</p> <p>ERO 2 Promote and support an optimal mix of renewable energy generation within the county to assist in meeting the targets set out in the National Renewable Energy Action Plan.</p> <p>ERO 3 Promote and encourage the use of renewable energy sources in appropriate locations, where this can be done in an environmentally sensitive manner.</p> <p>ERO 8 Encourage efforts to reduce energy usage across all sectors in support of the implementation of the National Energy Efficiency Action Plan 2007-2020.”</p> <p>ERO 10. Facilitate electricity and gas infrastructure improvements/installations which will not result in adverse impacts on the natural or built heritage of the county.</p> <p>ERO 12. Consider the identification of a strategic corridor in the county for major energy infrastructure.” (p. 109-110)</p> |
| Infrastructure and Services | Water and Waste Water Services | <p>Objectives:</p> <p>“WSO 4 Protect the source and raw water quality of all public and private water supply schemes throughout the county.</p> <p>WSO 7 Protect existing aquatic habitats in the case of surface waters”. (p. 140)</p> |
| Infrastructure and Services | Flooding | <p>Objectives:</p> <p>“FLO 4 Recognise, secure and promote the natural role of floodplains as a form of flood defence and an important environment and social resource.</p> <p>FLO 5 Promote an integrated sustainable approach to the management of development and flood risk”. (p. 146)</p> <p>Policies:</p> <p>“FLP 1 Prohibit development which would be directly exposed to flooding or which would exacerbate flooding in areas outside of the site of the proposed development itself”. (p. 147)</p> |

| MONAGHAN COUNTY DEVELOPMENT PLAN 2013-2019 | | |
|--|--|---|
| POLICY TOPIC | POLICY | POLICY OBJECTIVE |
| Infrastructure and Services | Major Accidents | <p>Policies:</p> <p><i>MAP 1. Protect areas of particular natural sensitivity or interest in the vicinity of establishments covered by this Directive, through appropriate safety distances or other appropriate measures where necessary.</i></p> <p><i>MAP 2. Facilitate the implementation of the “Seveso II and III” major accidents directives in respect of the siting of new establishments, modifications to existing establishments and major infrastructure projects including any proposed gas pipeline, rail links and major roads.</i></p> <p><i>MAP 3. Consult the Health and Safety Authority (HSA), where appropriate, when considering proposals for new development.</i></p> <p><i>MAP 4. The Council will have regard to the provision of the Fire Services Act 1981”. (p. 155)</i></p> |
| Development of Community Infrastructure | Community Facilities, Sports, Recreation, Amenity and Open Space | <p>Objectives for Recreation and Amenity:</p> <p><i>RAO 4. Protect the amenity of scenic and environmentally sensitive areas and promote the knowledge and appreciation of the natural amenities of the County.</i></p> <p><i>RAO 10. Maintain and conserve existing rights of way within the County.</i></p> <p><i>RAO 11. Identify on maps and by list those public rights of way giving access to mountains, lakeshores, riverbanks, canals or other place of natural beauty or recreational activity during the lifetime of the development plan, where resources are available to do so”. (p. 166)</i></p> |
| Development of Community Infrastructure | Walking and Cycling | <p>Objectives:</p> <p><i>CWO 5 Protect established walking routes from development which would adversely impact upon them”. (p. 169)</i></p> |
| Strategic Objectives for Settlements | Development Management | <p>Section 8.10.3 of the Plan is entitled “Power and Telecommunications”. This section states that:</p> <p><i>“The Councils will continue to co-operate with statutory and regulated bodies in the provision of power and communication facilities throughout the county. Section 6.6 in Chapter 6 of the Monaghan County Development Plan 2013–2019 contains the relevant objectives for telecommunications throughout County Monaghan”. (p. 197)</i></p> |
| Strategic Objectives for Settlements | Natural Heritage | <p>Objectives:</p> <p><i>SNO 2 Prohibit development that would detrimentally impact on the value or designation of areas of natural amenity in the towns.</i></p> <p><i>SNO 3 Protect individual trees, groups of trees and woodland areas because of their nature conservation value or their</i></p> |

| MONAGHAN COUNTY DEVELOPMENT PLAN 2013-2019 | | |
|--|-----------------------------------|--|
| POLICY TOPIC | POLICY | POLICY OBJECTIVE |
| | | <p>contribution to amenity of the town and require the retention of existing mature trees and hedgerows in all new developments except in exceptional circumstances.</p> <p>SNO 4 Prohibit development in Landscape Protection/Conservation Areas unless in exceptional circumstances, where it has been clearly proven to the Planning Authority that the works would not be contrary to the zoning objective as outlined in Section 8.3 in Chapter 8 Monaghan County Development Plan 2013-2019.</p> <p>SNO 5 Have regard to nature conservation issues when considering proposals for development which may detrimentally impact on habitats, species or features worthy of protection.” (p. 198)</p> |
| Strategic Objectives for Settlements | Built Heritage | <p>Objectives:</p> <p>“SBO 2 Protect and preserve the Protected Monuments and Structures located within the towns.</p> <p>SBO 3 Protect existing Architectural Conservation Areas by ensuring that all developments within them comply with the policies laid out in Chapter 4 Environment and Heritage, Monaghan County Development Plan 2013–2019 and the DEHLG Architectural Heritage Protection Guidelines. In these areas repair and refurbishment of existing buildings will be favoured over demolition and new build.</p> <p>SBO 4 To protect the architectural quality of the towns by investigating the potential of designating additional Architectural Conservation Area(s) (ACAs) in accordance with DEHLG Architectural Heritage Protection Guidelines, during the plan period. (p.199)</p> |
| Strategic Objectives for Settlements | Recreation and Amenity | <p>Objectives:</p> <p>“REO 2 Prohibit development on zoned recreation/open space lands unless where it is clearly demonstrated that it is of compatible amenity value and that there will be no adverse effect on the environment”.</p> <p>“REO 6 Maintain existing rights of way and investigate the creation of additional public rights of way either, by agreement or by use of compulsory powers”. (p. 200-201)</p> |
| Development Management Guidelines | Development in Towns and Villages | <p>Policies:</p> <p>“TVP 11 Development on the top of drumlins or on elevated or exposed lands shall be restricted to protect locally important views and landmarks.</p> <p>TVP 15 Promote the protection and conservation of the existing habitats within Towns and Villages.” (p. 313)</p> |

| MONAGHAN COUNTY DEVELOPMENT PLAN 2013-2019 | | |
|--|------------------------------------|--|
| POLICY TOPIC | POLICY | POLICY OBJECTIVE |
| Development Management Guidelines | Rural Accesses | <p>Policies:</p> <p><i>“RAP 1 Access should be taken from existing lanes where practical.</i></p> <p><i>RAP 2 New accesses should be positioned to minimise loss of hedgerow / trees.</i></p> <p><i>RAP 3 New access lanes/roads should run alongside existing hedgerows/boundaries and should follow the natural contours of the site. Sweeping driveways should be avoided.” (p. 329)</i></p> |
| Development Management Guidelines | Electricity and Gas Infrastructure | <p>Policies:</p> <p><i>“EGP 1 All projects concerning the development of electricity and gas infrastructure shall be considered under policies AAP1-AAP5 contained within Chapter 4, Environment and Heritage, of the Monaghan County Development Plan 2013-2019.</i></p> <p><i>EGP 2 Facilitate electricity and gas infrastructure improvements/installations which will not result in adverse impacts on the natural or built heritage of the county.</i></p> <p><i>EGP 3 The undergrounding of electricity transmission lines shall be considered in the first, as part of a detailed consideration and evaluation of all options available in delivering and providing this type of infrastructure. The development shall be consistent with international best practice with regard to materials and technologies that will ensure a safe, secure, reliable, economic, efficient and high quality network, and mitigation measures shall be provided where impacts are inevitable.” (p. 340)</i></p> |
| Development Management Guidelines | Tourism | <p>Policy:</p> <p><i>“TOO 3 Resist development that would adversely affect the natural resources upon which tourism is based”. (p. 346)</i></p> |
| Development Management Guidelines | Development on National Routes | <p>Policy:</p> <p><i>“NRP 8 The Council will severely restrict the creation of new accesses or the intensification of use of an existing access in speed transition zones onto national roads between the 50 km/hr and 60 km/hr limits.</i></p> <p><i>NRP 9 Where development is proposed in close proximity to existing or planned national roads, the applicant will be required to address potential negative impacts arising from national roads such as noise, air, and light pollution through mitigating impacts such as appropriate design of buildings, landscaping features and site layout”.</i></p> <p>(p.348)</p> |

CAVAN COUNTY DEVELOPMENT PLAN 2014 - 2020

DRAFT

| CAVAN COUNTY DEVELOPMENT PLAN 2014 - 2020 | | |
|---|-----------------------------------|--|
| POLICY TOPIC | POLICY | POLICY OBJECTIVE |
| Vision | Development Vision For The County | <p>The vision of the Plan is as follows:</p> <p><i>“That Cavan in 2020 will be a place that we all can be proud of; a place where people can have a good quality of life; a better place to live, work and enjoy.” (p.25)</i></p> <p>The Plan sets out that:</p> <p><i>“This vision emphasises the important link between the sustainable development of the County and the quality of life of the people who live here. A number of strategic aims emerge from this vision.” (p.25)</i></p> <p>The Strategic Aims are set out as follows in the Plan:</p> <ul style="list-style-type: none"> • <i>“Protect and enhance the cultural, built and natural heritage of the County.</i> • <i>Recognise and cater for the physical, cultural, religious and social diversity of the County’s people.</i> • <i>Encourage the development of employment opportunities throughout the county.</i> • <i>Ensure equal access to services and amenities.</i> • <i>Provide good quality, accessible leisure, social and amenity services and spaces in an equal manner across the county.</i> • <i>Ensure the principles of quality of life and sustainable development informs all decisions which relate to development within the county.</i> • <i>To provide good quality services infrastructure including adequate and appropriate drinking water and waste water treatment.” (p.25-26)</i> |
| Core Policies | Strategy Renewable Energy | <p>The Plan contains 20 core strategy policies which will inform and link together the differing sections of the plan. Core Strategy Policy CSP15 pertains to the generation of energy from renewable sources, this policy states:</p> <p><i>“CSP15 Proposals for the generation of energy from renewable sources will be supported, provided that the wider environmental benefits are not outweighed by any detrimental impacts of the proposed development, (including any electricity transmission facilities needed, on the landscape, public safety, and the local environment.” (p.68)</i></p> |

| CAVAN COUNTY DEVELOPMENT PLAN 2014 - 2020 | | |
|---|--|--|
| POLICY TOPIC | POLICY | POLICY OBJECTIVE |
| Energy- Physical Infrastructure | Electricity | <p>Section 4.7.1 of the Plan sets out the following:</p> <p><i>“Cavan County Council supports the provision of new high voltage electrical infrastructure, including high voltage transformer stations and new overhead transmission power lines. This infrastructure will be required for reinforcement of the transmission network, related to growing electricity demand from existing customers, as well as, the connection of new generation and large demand customers e.g. industry.” (p.134)</i></p> |
| Energy- Physical Infrastructure | Electricity Development Of Overhead Power Lines | <p>Section 4.7.1 of the Plan states the following in relation to Overhead Power Lines:</p> <p><i>“Bulk electricity, generated in the various Generating Stations in Ireland is transported around the Country using a system of 110kV, 220kV and 400kV overhead lines to the major load centres. Underground cables are generally used in heavily populated areas where there is no room to install overhead lines. It is recognised that overhead lines are faster and easier to repair and not subject to excavating activities, however, underground cabling will be encouraged in heavily populated areas, if feasible. The development of secure and reliable electricity transmission infrastructure is recognised as a key factor for supporting economic development and attracting investment to the area.</i></p> <p><i>Cavan County council takes cognisance of the ‘Government Policy Statement on the Strategic Importance of Transmission and Other Energy Infrastructure’ issued by the Department of communications, Energy and Natural resources” (p. 134-135)</i></p> |
| Energy- Physical Infrastructure | Electricity Objectives | <p>The following Electrical Objectives (PI – Physical Infrastructure) are set out in Section 4.7.1 of the Plan:</p> <p><i>“PIO06 Where development is of a scale that requires approval under the Strategic Infrastructure Act, 2006, the applicants / promoters shall include as an integral part of their planning approval / planning application documentation, a study by a suitably qualified independent person / body demonstrating whether the proposal is incorporating the most appropriate technology available and method of construction including a comprehensive examination (in the case of transmission lines) of the under-grounding of such services. The applicant shall also ensure that planning applications involving the siting of electricity power lines and other overhead cables, consider in full, the impacts of such development on the landscape, nature conservation, archaeology, residential and visual amenity.</i></p> <p><i>PIO07 In routing new overhead power lines, on the grounds of general amenity, and where possible. EirGrid and ESB Network shall seek to achieve the maximum separation distance to residential and other property generally occupied by human beings while also seeking to avoid, or minimise impact upon, other identified technical and environmental constraints. All proposals for new residential and other development in proximity to existing overhead power lines shall be assessed in reference to the provisions of the Electricity (Supply) (Amendment) (No. 2) Act, 1934 regarding separation distance. Construction works occurring in proximity to power lines shall have</i></p> |

| CAVAN COUNTY DEVELOPMENT PLAN 2014 - 2020 | | |
|---|---|---|
| POLICY TOPIC | POLICY | POLICY OBJECTIVE |
| | | <p>regard to relevant published Electricity Supply Board Guidelines such as the “Code of Practice for Avoiding danger from Overhead Electricity Lines” and other nationally accepted standards or guidelines.</p> <p>PIO108 To support the infrastructural renewal and development of electricity networks in the County and recognise the development of secure and reliable electricity transmission infrastructure as a key factor for supporting economic development and attracting investment to the area and to support the infrastructural renewal and development.</p> <p>PIO109 Cognisance will be taken of the ‘Code of Practice’ between the DECLG and EirGrid (2009).”</p> <p>PIO110 To ensure that High Voltage electrical lines must be constructed and monitored in accordance with current ‘Guidelines of the International Commission on Non-Ionising Radiation Protection (ICNIRP)’ and Commission for Energy Regulation (CER).”</p> <p>PIO111 To support the undergrounding of HV powerlines, where technically feasible, economically viable and environmentally appropriate.”</p> <p>PIO112 To support the development of Hydro Electric Power, as appropriate.”(p.135-136-91)</p> |
| Energy - Physical Infrastructure | Energy Renewable Energy Objective | “It is an objective of the Planning Authority to encourage and facilitate renewable forms of energy production” (p. 137). |
| Built Heritage & Archaeology | Protected Structures Policy and Objectives | <p>The Protected Structures Policy as set out in the Plan is as follows:</p> <p>“BHP1 To protect, preserve and enhance the architectural heritage of County Cavan by taking into consideration the advice contained in the ‘Architectural Protection, Guidelines for Planning Authorities’, 2004. To adhere to the standards advocated in the ‘Principles of Conservation’ published by the Department of the Environment, Heritage and Local Government in undertaking works on elements of the built heritage and to protect all structures or parts of structures, where appropriate, that are of special architectural, historical, archaeological, artistic, cultural, scientific social or technical interest, which are included in the RPS”. (p. 178)</p> <p>The Protected Structures Objectives as set out in the Plan are as follows:</p> <p>“BHO2 Review and maintain the Record of Protected Structures on an on-going basis and to have regard to the NIAH, as appropriate.</p> <p>BHO3 To protect the architectural heritage of Cavan and to include all structures, or parts of structures, considered to be of special architectural, historical, archaeological, artistic, cultural, scientific, social or technical interest in the RPS, including modern structures.</p> <p>BHO4 To promote cultural tourism in Cavan and to fully recognise the potential of the County’s architectural</p> |

| CAVAN COUNTY DEVELOPMENT PLAN 2014 - 2020 | | |
|---|--|--|
| POLICY TOPIC | POLICY | POLICY OBJECTIVE |
| | | <p>heritage in this role. This shall include the upgrading of existing heritage interpretation methods including the use of a variety of media to engage visitors. This will help to make the County's heritage story relevant to the mass tourism market, from children to older visitors and to attract and engage a wider number and variety of people.</p> <p>BHO5 Prohibit development in gardens or landscapes which are deemed to be an important part of the setting of Protected Structures or where they contribute to the character of an ACA." (p. 178-179)</p> |
| Built Heritage & Archaeology | Archaeological Heritage Policies and Objectives | <p>Section 7.5.2 of the Plan sets out the following Policies:</p> <p>"BHP5 To protect and enhance archaeological monuments, their settings and zones of archaeological potential."</p> <p>BHP6 To facilitate appropriate guidance in relation to the protection of the archaeological implications of a proposed development.</p> <p>BHP7 To promote public awareness of the rich archaeological heritage in the area.</p> <p>BHP8 To secure the preservation of sites and features of historical and archaeological interest" (p. 185)</p> <p>The Archaeology Objectives set out in the Plan are as follows:</p> <p>"BHO17 Ensure the preservation in-situ of any part of our archaeological heritage is to be undertaken by Archaeological assessment which is to be carried out by a suitably qualified professional archaeologist.</p> <p>BHO18 The avoidance, as far as possible, of developmental impacts on the archaeological heritage of the County. The preservation in-situ of archaeological monuments and sites as a preferred option.</p> <p>BHO19 Cognisance will be taken of the 'Code of Practice between ESB National Grid and the Minister of the ECLG in relation to Archaeological Heritage". (p. 185-186)</p> <p>Archaeological Investigations</p> <p>"BHO20 Ensure that archaeological material is not disturbed so that an opportunity will be given to investigate and record any material of archaeological value that may be found on sites or to protect them in-situ.</p> <p>BHO21 Where archaeology is likely to be encountered or impacted upon by a proposed development, developers will be advised of their obligations under the 'National Monuments (Amendment) Act', 1994. Development that impact on the archaeology of the County will be treated as follows:</p> <ul style="list-style-type: none"> • Within the zone of archaeological potential, archaeological remains will be investigated, recorded, and/or preserved. • Outside the zone of archaeological potential, where in the opinion of the Planning Authority, developments involve major ground disturbances; conditions relating to archaeology may be applied. |

| CAVAN COUNTY DEVELOPMENT PLAN 2014 - 2020 | | |
|---|---|--|
| POLICY TOPIC | POLICY | POLICY OBJECTIVE |
| | | <ul style="list-style-type: none"> • The Local Authority will require that archaeological investigations be undertaken by a licensed archaeologist prior to the commencement of development. • The developer will be liable for the cost of archaeological investigations. • The Local Authority may require the developer to submit a report, prepared by a suitably qualified archaeologist. On the archaeological implications of the proposed development. The Planning Authority may impose conditions requiring: <ul style="list-style-type: none"> ○ Professional archaeological supervision of site excavations. ○ Funding by the applicant for archaeological monitoring, testing and/or assessment. ○ Preservation of all or part of any archaeological remains. ○ Conditions may be imposed which modify the development in order to facilitate investigation or preservation. ○ Developers will be encouraged to supply an archaeological assessment and method statement outlining construction procedures as part of their planning application. <p>BHO22 Ensure that all planning applications for new development, refurbishment and restoration works within identified Zones of Archaeological Potential and within close proximity to individual Recorded Monuments or Sites, are submitted to the Department of Arts, Heritage and Gaeltacht (DAHG). On receipt, the DAHG shall provide advice and recommendations regarding treatment of archaeology as an integral part of the development process. The planning decision made by the Planning Authority will have due regard to the recommendations made by the DAHG.</p> <p>BHO24 Applicants may be formally requested, as part of a request for further information or as a planning condition attached to the grant of permission, to have a report prepared by an archaeologist on the archaeological implications, if any, of the proposed development. The archaeologist shall be employed by the applicant/developer. These archaeological reports shall be submitted to the Planning Authority, the National Museum and the DAHG as appropriate, for their consideration prior to the making of the planning decision in the case of requested additional information, and prior to the commencement of site preparation and/or construction works in the case of archaeological reports requested as a condition attached to the grant of planning permission.” (p.186-187)</p> |
| Natural Heritage And Environment | Guiding Principles For Natural Heritage | <p>“The following principles guide the Council’s heritage objectives and policies:</p> <ol style="list-style-type: none"> 1. Avoid negative impacts or unnecessary impacts to natural heritage; 2. Promote natural heritage as a key principle to every development; 3. Ensure that all developments include adequate provisions to mitigate the effects of impact upon heritage where it can be avoided; |

| CAVAN COUNTY DEVELOPMENT PLAN 2014 - 2020 | | |
|---|--|--|
| POLICY TOPIC | POLICY | POLICY OBJECTIVE |
| | | <i>4. Maximise the benefits to the County arising from its unique natural heritage.” (p.190)</i> |
| Natural Heritage And Environment | Natural Heritage and Environmental Policies | <p>The BRPG (2010-2020) embraces natural heritage, biodiversity and landscape and Section 8.2 reflects the principles and guidelines set out therein in relation Natural Heritage and Environmental Policies as follows:</p> <p><i>“NHEP1 To protect, conserve, manage, enhance and safeguard natural amenity assets and natural heritage features for future generations while maximising their recreational, amenity and tourism potential for the present generation by resisting development that could have a negative impact.</i></p> <p><i>NHEP2 To maximise the social, economic and environmental benefits that may be derived from the conservation and management of Cavan’s Natural Heritage and green infrastructure.</i></p> <p><i>NHEP3 To implement, in partnership with Cavan County Heritage Forum, relevant stakeholders and the wider community, the Cavan County Heritage and Biodiversity Plans and any subsequent revisions. The Cavan County Heritage and Biodiversity Plans shall be integrated into lower level Plans to ensure there is a co-ordinated approach to protecting natural and built heritage.” (p. 190-191)</i></p> |
| Natural Heritage And Environment | Natural Heritage and Environmental Policies | <p>Section 8.3 sets out the Natural Heritage Policies as follows:</p> <p><i>“NHEP4 To protect, manage, conserve and seek to enhance the County’s biodiversity.</i></p> <p><i>NHEP5 To integrate biodiversity consideration into all Council activities through the County Biodiversity Action Plan process.</i></p> <p><i>NHEP6 To ensure the protection of species of flora and fauna afforded legal protection under Irish and European Legislation.</i></p> <p><i>NHEP7 To assess the impact on biodiversity of proposals for large developments, particularly those on greenfield sites, or in environmentally sensitive areas. Such developments must include measures for the enhancement and protection of biodiversity.</i></p> <p><i>NHEP8 To increase public participation in biodiversity conservation through community led initiatives.” (p.191-192)</i></p> <p>Section 8.3 sets out the Natural Heritage Objectives as follows:</p> <p><i>“NHEO1 To consider aims, objectives and actions identified in Cavan County Heritage and Biodiversity Plans and any subsequent revisions, during the lifetime of the Cavan County Development Plan. To integrate as appropriate, the aims, objective and actions identified in Cavan County Heritage and Biodiversity Plans into any lower level plans arising from the implementation of this plan.</i></p> <p><i>NHEO2 To promote the conservation of biodiversity outside of designated areas, including features such as</i></p> |

| CAVAN COUNTY DEVELOPMENT PLAN 2014 - 2020 | | |
|---|---|--|
| POLICY TOPIC | POLICY | POLICY OBJECTIVE |
| | | <p>wetlands, woodlands, hedgerows and uplands.</p> <p>NHEO3 To protect and enhance important landscape features including streams, rivers, canals, lakes, and associated wetlands such as reedbeds and swamps; ponds, springs, bogs, fens, trees, woodland and scrub, wildlife and riparian corridors, hedgerows and other boundary types such as stone walls and ditches which are of importance for wild flora and fauna.” (p.192)</p> |
| Natural Heritage And Environment | <p>Sites designated in County Cavan</p> <p>Protected Areas Policies</p> | <p>Section 8.4.2 of the Plan sets out the Protected Areas Policies as follows:</p> <p>“NHEP9 Development on or adjacent to National or European designated sites or proposed designated sites during the lifetime of this plan will be permitted only where an assessment has being carried out to the satisfaction of Cavan County Council, and in consultation with the NPWS and where the overall integrity of the site will not be compromised or adversely affected.”</p> <p>NHEP10 To have regard to the views of the NPWS in respect of proposed development where such development may have an impact on a designated National or European site or proposed site for designation.”</p> <p>“NHEP11 To continue to undertake surveys and collect data that will assist the Council in building its knowledge base and meeting its obligations under Article 6 of the Habitat Directives.”. (p. 195)</p> |
| Natural Heritage And Environment | <p>Sites designated in County Cavan</p> <p>Protected Areas Objectives</p> | <p>Section 8.4.2 of the Plan sets out the Protected Areas Objectives as follows:</p> <p>“NHEO4 To ensure an Appropriate Assessment (AA) in accordance with Article 6(3) and Article 6(4) of the Habitats Directive, and in accordance with the DECLG ‘Appropriate Assessment of Plans and Projects in Ireland – Guidance for Planning Authorities’, 2009 and relevant EPA and European Commission guidance documents, is carried out in respect of any Plan or Project likely to have significant effect on a Natura 2000 site/s, either individually or in combination with other plans or projects, in view of the site’s conservation objectives.”</p> <p>“NHEO5 To protect and conserve the conservation value of SPAs, SACs and NHAs as identified by the Minister for DAHG and any other sites that may be proposed for designation during the lifetime of this plan.” (p. 195)</p> |

| CAVAN COUNTY DEVELOPMENT PLAN 2014 - 2020 | | |
|---|--|--|
| POLICY TOPIC | POLICY | POLICY OBJECTIVE |
| Natural Heritage And Environment | Undesignated Sites Policies and Objectives | <p>Section 8.4.3 of the Plan sets out the Policies in relation to undesignated sites as follows:</p> <p><i>“NHEP12 To conserve the existing wide range of flora, fauna and wildlife habitats in the county through the preservation of ecological corridors and networks vital to the migration, dispersal and genetic exchange of wild species. To designate County Biodiversity Sites within the lifetime of this plan and to protect the ecological integrity of these sites.”</i> (p.196)</p> <p>Section 8.4.3 of the Plan sets out the Objectives in relation to undesignated sites as follows:</p> <p><i>“NHEO6 To implement the actions of the Cavan County Biodiversity Plan and any subsequent revisions in fulfilment of the requirements of the National Biodiversity Plan.”</i></p> <p><i>“NHEO7 To continue to map the habitats of the county which will enable planning for future development to occur in a sensitive and sustainable manner and ensure that this mapping informs the development management process.”</i> (p. 196)</p> |
| Natural Heritage And Environment | Geological Heritage Policy and Objectives | <p>Section 8.5 of the Plan sets out the Polices in relation to the Geological Heritage as follows:</p> <p><i>“NHEP13 To have regard to the geological and geomorphological heritage values of County Cavan’s geological heritage sites and to avoid inappropriate development, through consultation with the Geological Survey of Ireland.”</i>(p.197)</p> <p>Section 8.5 of the Plan sets out the Objectives in relation to the Geological Heritage as follows:</p> <p><i>“NHEO8 To have regard for the geological heritage sites identified in the geological audit of sites completed for County Cavan.”</i></p> <p><i>“NHEO9 To raise awareness of the importance of the geological heritage of the county and to disseminate information on sites of geological heritage value in County Cavan, when this information becomes available.”</i> (p.197)</p> |

| CAVAN COUNTY DEVELOPMENT PLAN 2014 - 2020 | | |
|---|--|---|
| POLICY TOPIC | POLICY | POLICY OBJECTIVE |
| Natural Heritage And Environment | Geopark Policy and Objectives | <p>Section 8.5.1 of the Plan sets out the Policies in relation to Geoparks: <i>“NHEP14 To conserve and manage the geological resources of a discrete area to develop sustainable tourism, enterprise and community life.”</i> (p.197)</p> <p>Section 8.5.1 of the Plan sets out the Objectives in relation to Geoparks: <i>“NHEO10 To facilitate and encourage the development of geotourism and the recreational potential of County Cavan through increased social use of the landscape, with attendant conservation, economic, social and community benefits within the region.”</i> (p.197) <i>“NHEO11 To co-ordinate the continuing development of strategic walking routes, trails and other countryside recreational opportunities.”</i> <i>“NHEO12 To enhance the geodiversity, biodiversity and natural environments of the region including additional measures to conserve geosites and natural habitats where appropriate.”</i> <i>“NHEO13 To develop knowledge and understanding of geology, related Earth Sciences, endangered habitats and associated environmental issues through education and research programmes.”</i> <i>“NHEO14 To encourage enquiry through fieldwork and inspire scientific research through education and research programmes.”</i></p> |
| Natural Heritage And Environment | Invasive Species Policy and Objective | <p>Section 8.5.1 of the Plan sets out the Policy in relation to Invasive Species: <i>“NHEP15 To support initiatives, which reduce the risk of invasions, help control and manage and prevent the spread of new and established invasive species, monitor impacts and raise public awareness.”</i> (p. 198)</p> <p>Section 8.5.1 of the Plan sets out the Objective in relation to Invasive Species: <i>“NHEO15 To encourage the use of native species in amenity planting and stocking and related community actions to reduce the introduction and spread of non-native species.”</i> (p. 198)</p> |
| Natural Heritage And Environment | Wetlands Policy and Objective | <p>Section 8.5.2 of the Plan sets out the Policy in relation to Wetlands: <i>“NHEP16 To protect existing wetlands from destruction, infilling, fragmentation and degradation.”</i> (p. 199)</p> <p>Section 8.5.2 of the Plan sets out the Objective in relation to Wetlands: <i>“NHEO16 To resist development that would destroy, fragment and degrade wetlands.”</i> (p. 199)</p> |

| CAVAN COUNTY DEVELOPMENT PLAN 2014 - 2020 | | |
|---|---|--|
| POLICY TOPIC | POLICY | POLICY OBJECTIVE |
| Natural Heritage And Environment | Woodlands, Trees, Hedgerows and Stonewalls Policies and Objectives | <p>Section 8.5.3 of the Plan sets out the Policies in relation to Woodlands, Trees, Hedgerows and Stonewalls:</p> <p><i>“NHEP17 To continue to co-operate with relevant stakeholders to improve public access to State forests for amenity purposes and consider development which will enhance the amenity provided by existing trees and woodlands.”</i></p> <p><i>“NHEP18 To promote awareness, understanding and best practice in the management of Cavan’s woodland, tree, hedgerow and stone wall resource.” (p. 199)</i></p> <p>Section 8.5.3 of the Plan sets out the Objectives in relation to Woodlands, Trees, Hedgerows and Stonewalls:</p> <p><i>“NHEO17 To encourage the retention of mature trees and the use of tree surgery rather than felling where possible when undertaking, approving or authorising development.”</i></p> <p><i>“NHEO18 To protect Champion and Heritage Trees where identified on the Tree Register of Ireland and Heritage Tree Database when undertaking, approving, or authorising development.”</i></p> <p><i>“NHEO19 To encourage the use of native species, wherever possible, in Cavan County Council’s own landscaping work, and on Council property.”</i></p> <p><i>“NHEO20 To promote and encourage the planting of native hedgerow and species of local provenance.”</i></p> <p><i>“NHEO21 To encourage the retention of hedgerows and stonewalls and other distinctive boundary treatments in rural areas and prevent loss and fragmentation, where possible. Where removal of a hedgerow or stone wall is unavoidable, mitigation by provision of the same type of boundary will be required.” (p. 200)</i></p> |
| Natural Heritage And Environment | Landscape & Amenity Areas General Policy and Objectives in respect of Landscape Characterisation | <p>Section 8.7 of the Plan sets out the Policies for Landscape Characterisation as follows:</p> <p><i>“NHEP19 To protect the landscape character, quality, and local distinctiveness of County Cavan in accordance with government policy and guidelines as set out above and recognise the Landscape Categorisation of County Cavan.”</i></p> <p><i>“NHEP20 To require that any necessary assessments, including landscape and visual impact assessments are provided when undertaking, authorising, or approving development.”(p. 202)</i></p> <p>Landscape Characterisation Objectives as per the Plan:</p> <p><i>“NHEO22 To protect and enhance the landscape of County Cavan by ensuring development occurs in a manner that has regard to the character (type of landscape or character area) and sensitivity (visual impact) of the</i></p> |

| CAVAN COUNTY DEVELOPMENT PLAN 2014 - 2020 | | |
|---|---|---|
| POLICY TOPIC | POLICY | POLICY OBJECTIVE |
| | | <p>landscape”.</p> <p>“NHEO23 To support efforts to identify and designate vulnerable landscapes in County Cavan in order to maintain their character.”</p> <p>“NHEO24 To identify, protect and enhance landscapes and landscape features of special environmental, geological, and geomorphological, archaeological, historic or cultural interest.”</p> <p>NHEO25 To protect and enhance the visual integrity, distinctiveness, character, scenic value and visual quality of the sensitive and outstanding landscapes, scenic areas and High Amenity Areas from intrusive and/or unsympathetic developments. Protect sensitive areas from injurious development, while providing for development that will benefit rural community and visitors. Ensure that, where an overriding need is demonstrated for a particular development in the vicinity of sensitive landscape careful consideration is given to site selection. Proposed developments should be appropriate in scale and be sited, designed and landscaped in a manner which minimises potential adverse impacts on the landscape. Proposed developments, where located within or adjacent to sensitive landscapes, may be required to provide a landscape report detailing how the proposal will impact on the landscape and mitigation measures to be taken. Proposed development which have a detrimental impact on the landscape will not normally be permitted. Co-operate with adjoining local authorities to support the co-ordinated designation of sensitive landscape particularly where transboundary vulnerabilities are identified.</p> <p>(p. 202-203)</p> |
| Natural Heritage And Environment | Landscape Features Special Landscape Policy Areas Policy and Objective | <p>Section 8.8.1 of the Plan sets out the following Special Landscape Policy Areas Objectives:</p> <p>Areas of Special Landscape Interest</p> <p>“NHEO26 To maintain the scenic and recreation value of these areas by restricting all adverse uses and negative visual impacts.” (p. 204)</p> <p>County Heritage Sites</p> <p>“NHEO27 To restrict incompatible development in order to protect the amenity, scientific and historical values of these areas.”(p. 205)</p> <p>Scenic Views and Viewing Points</p> <p>“NHEO28 To restrict development that would obstruct views and to minimise visual intrusion by only permitting compatible uses.”</p> <p>“NHEO29 To ensure that the location, design and visual prominence of developments are examined, including possible effects on views from the public realm toward sensitive or vulnerable landscape features.” (p. 206)</p> |

| CAVAN COUNTY DEVELOPMENT PLAN 2014 - 2020 | | |
|---|--------|--|
| POLICY TOPIC | POLICY | POLICY OBJECTIVE |
| | | <p>Scenic Routes</p> <p><i>“NHEO30 To regulate development that would seriously obstruct and detract from views of high scenic value from designated Scenic Routes.”</i></p> <p><i>“NHEO31 To maintain and protect the natural landscapes visual character which is recognised to be of an exceptional high amenity value.” (p. 206-207)</i></p> <p>Forest Parks and Other Parks</p> <p><i>“NHEO32 To regulate development within parks to maximise recreational, amenity and community uses.” (p. 207)</i></p> <p>Major Lakes and Lake Environs</p> <p><i>“NHEO33 To maintain the amenity value of major lakes and their environs within a landscape, recreational and ecological context by restricting and regulating development that would prejudice use and enjoyment of the areas, give rise to adverse visual impacts or threaten habitats through disposal of effluents.”</i></p> <p><i>“NHEO34 To implement the above along the shorelines of these lakes and the immediate area adjoining, including skyline development on surrounding hill crests.” (p.208)</i></p> <p>Lakeside Amenity Areas</p> <p><i>“NHEO35 To regulate development on adjoining lands, to ensure that public use is not prejudiced by incompatible uses or adverse visual impact.”(p. 209)</i></p> <p>Riverside Amenity Areas</p> <p><i>“NHEO36 To regulate all development on lands adjoining these rivers in order to maintain their amenity and ecological value.” (p. 209)</i></p> <p>Walking Routes Policy</p> <p><i>“NHEP21 To protect these amenity areas, permitting only very limited forms of development in these locations.” (p. 209)</i></p> <p>Walking Routes Objectives</p> <p><i>“NHEO37 To require developments likely to have an adverse impact on special landscape policy areas to identify and assess these impacts. Such applications will be required to carry out studies to establish baseline parameters and appropriate measures will be required, as are deemed necessary, to protect the environment.2</i></p> <p><i>“NHEO38 To examine, review and refine Special Landscape Policy areas during the lifetime of the Development Plan.” (p. 209-210)</i></p> |

| CAVAN COUNTY DEVELOPMENT PLAN 2014 - 2020 | | |
|---|---|---|
| POLICY TOPIC | POLICY | POLICY OBJECTIVE |
| Natural Heritage And Environment | Landscape Features Inland Waterways Policy and Objectives | <p>Section 8.9 of the Plan sets out the Policy in relation to Inland Waterways:</p> <p><i>“NHEP21 To protect and enhance the natural heritage and landscape character of the Waterways and to maintain it free from inappropriate development and to provide for public access, where feasible, acknowledging the existence of contiguous Natura 2000 sites.”</i> (p. 210)</p> <p>Section 8.9 of the Plan sets out the objectives in relation to Inland Waterways:</p> <p><i>“NHEO39 To protect the biodiversity of rivers, streams and other water courses of the Inland Waterways to maintain them in an open state and to discourage their culverting or realignment.”</i></p> <p><i>“NHEO40 To consult with, as appropriate, the Inland Fisheries Board in relation to any development that could have a potential impact on the aquatic ecosystems and associated riparian habitats.”</i></p> <p><i>“NHEO41 To consult with Waterways Ireland, the NPWS, the DECLG and the Inland Waterways Association on the development proposals that may affect inland waterways, rivers, lakes, canals or watercourses.”</i></p> <p><i>“NHEO42 To ensure that the County’s watercourses are retained for their biodiversity and flood protection values and to conserve and enhance, where possible, the wildlife habitats of the county’s rivers and riparian zones, lakes, canals and streams which occur outside of designated areas to provide for a network of habitats and biodiversity corridors throughout the county.”</i> (p. 211)</p> |
| Natural Heritage And Environment | Landscape Features Public Rights of Way Policy and Objective | <p>Section 8.10 of the Plan sets out the Policy in relation to Public Rights of Way:</p> <p><i>NHEP22 To preserve and protect for the common good, existing public rights of way which give access to places of natural beauty or recreational utility.</i></p> <p>Section 8.10 of the Plan sets out the Objectives in relation to Public Rights of Way:</p> <p><i>NHEO43 To identify and protect, over the lifetime of the plan, further existing rights of way which give access to places of natural beauty or recreational utility.</i></p> <p><i>NHEO44 Existing Public Rights of Way and established walking routes shall be identified prior to any new planting, new infrastructural development and any new energy / telecommunications developments and shall be maintained as same.</i></p> <p><i>NHEO45 To identify the existing public rights of way which give access to mountains, lakeshores, riverbanks or other places of natural beauty or recreational activity using the following methodology:</i></p> <ul style="list-style-type: none"> • <i>Place an advert in local papers seeking submissions from the public to identify public rights of way which give access to mountains, lakeshores, riverbanks or other places of natural beauty or recreational utility.</i> • <i>Identify existing rights of ways, paths, and access points to mountains, lakeshores, riverbanks or other</i> |

| CAVAN COUNTY DEVELOPMENT PLAN 2014 - 2020 | | |
|---|---|--|
| POLICY TOPIC | POLICY | POLICY OBJECTIVE |
| | | <p><i>places of natural beauty or recreational activity.</i></p> <ul style="list-style-type: none"> • <i>Identify access points to seashore, mountain, lakeshore, riverbank or other places of natural beauty or recreational activity which the Council have maintained or repaired with a view to identifying public rights of way.</i> • <i>Carry out a desktop analysis of public records, maps, aerial photographs and newspaper accounts to identify reputations of public rights of way.</i> • <i>Once the list is compiled, advertise and put it on display. The public will be invited to make submissions on the validity of the public rights of way.</i> <p><i>The Local Authority will endeavor to verify and list the public rights of way and begin the formal process for designating rights of way under Section 14 of the Planning and Development Act 2000 (as amended). Vary the Plan to include the list and map showing the public rights of way. (p.212-213)</i></p> |
| Natural Heritage And Environment | Landscape Features Green Infrastructure Policies and Objective | <p>Section 8.10 of the Plan sets out the Policies in relation to Green Infrastructure:</p> <p><i>“NHEP23 To develop and support the implementation of a Green Infrastructure Strategy for County Cavan during the lifetime of this plan.</i></p> <p><i>NHEP24 To recognise Green Infrastructure as a means for conserving, protecting and managing ecological corridors and networks, that link National E.U. designated sites.</i></p> <p><i>NHEP25 To encourage physical activity and improved health and well-being by providing green spaces for walking and cycling and by providing attractive and safe routes linking key green space sites, parks and open spaces and heritage assets where feasible and appropriate and resist development that would damage, degrade, fragment or prejudice the green infrastructure network.”</i></p> <p>Section 8.10 of the Plan sets out the Objectives in relation to Green Infrastructure:</p> <p><i>“NHEO46 To undertake a Green Infrastructure Strategy for County Cavan during the lifetime of this Development Plan and to ensure that County Cavan’s Natura 2000 sites are central to this strategy.</i></p> <p><i>NHEP47 To identify sites of local biodiversity value in County Cavan over the lifetime of this plan.</i></p> <p><i>NHEO48 To protect existing green infrastructure in the county and to provide additional green infrastructure, where possible.</i></p> <p><i>NHEO49 To require that all Land Use Plans protect, manage and provide where possible green infrastructure in an integrated and coherent manner.”(p. 214)</i></p> |

| CAVAN COUNTY DEVELOPMENT PLAN 2014 - 2020 | | |
|---|--|---|
| POLICY TOPIC | POLICY | POLICY OBJECTIVE |
| Natural Heritage And Environment | Landscape Features Water Resources and Quality Policies and Objective | <p>Section 8.12.1 sets out the Water Protection Policies:</p> <p>NHEP26 To protect the water resources of County Cavan.</p> <p>NHEP27 To protect the rivers, streams, lakes and all other watercourses in the County, in order to promote sustainable and suitable habitats for flora and fauna.</p> <p>NHEP28 To promote the engagement of developers and regulators in sustainable development and encourage a high standard of environmental protection. The 'precautionary principle' will apply where a significant risk to the environment exists.</p> <p>NHEP29 To achieve good status in all our waterbodies and prevent the deterioration of existing quality status in all waterbodies in accordance with the requirements of the Water Framework Directive (WFD) and to any development where the potential adverse effects are not fully understood, in which case the development shall not proceed. The 'burden of proof' shall be solely with the applicant to ensure that the proposed activity will not cause significant environmental harm.</p> <p>NHEP30 Ensure that all industrial or agricultural developments generating manure, organic fertilizer and sludge that are dependent on the off-site recovery or disposal of waste take account area mapping into account. Including lands with impaired drainage or percolation properties and lands where rock outcrop and extreme vulnerability of groundwater is present. Restrictions shall apply in areas where water source catchments are present.</p> <p>NHEP31 Ensure the implementation and enforcement of the European Communities, 'Good Agricultural Practice for Protection of Waters Regulations' (2009) and associated European Communities 'Good agricultural Practice for Protection of Waters Regulations', 2010- S.I.610 of 2010." (p. 219-220)</p> <p>Section 8.12.1 sets out the Water Protection Objectives:</p> <p>NHEO50 All applications for development shall be assessed in terms of the potential impact on the quality of surface waters through the implementation of, where applicable, the RBMP's objectives and targets set under the following; 'Neagh Bann International River Basin District', 'Water Matters' and 'North Western International River Basin District: Water Matters', 'Shannon International River Basin District: Water Matters' and the 'Eastern International River Basin District: Water Matters'.</p> <p>NHEO51 All development applications are assessed in compliance with the 'European Communities Environmental Objectives on (Surface Waters) Regulations' (2009) (S.I. No 272 of 2009) and the 'European Communities Environmental Objectives Groundwater Regulations' 2010 (S.I. No. 9 of 2010).</p> <p>NHEO52 Ensure that the protection of all known and potential groundwater reserves in County Cavan are met through the effective implementation of the Groundwater Protection Scheme for County Cavan.</p> <p>NHEO53 Promote best practice in design, layout construction and operation of all new developments and re-</p> |

| CAVAN COUNTY DEVELOPMENT PLAN 2014 - 2020 | | |
|---|--|--|
| POLICY TOPIC | POLICY | POLICY OBJECTIVE |
| | | <p>developments through the requirement for the submission of Sustainable Urban Drainage Systems (SUDS). Developments shall be designed to ensure both water quality protection and flood minimisation are included in proposals where significant hard surfaces are proposed for commercial, industrial, intensive agriculture, public and institutional or multi-residential developments.</p> <p>NHEO54 Ensure that, where instances of pollution arise, the enforcement of planning conditions relating to the installation, operation and maintenance of on-site wastewater treatment or septic tanks is carried out jointly with the Environment and Planning Sections.</p> <p>NHEO55 To encourage the connection of all unconnected premises, within town boundaries, to the existing wastewater treatment plants, where available.</p> <p>NHEO56 To support the continued development of the wastewater leak detection programme and the use of a strategic metering system to aid in leak detection for the protection of existing water resources.”(p. 220-221)</p> |
| Natural Heritage And Environment | Landscape Features Climate Policies and Objective | <p>Section 8.13 sets out Policies on Air, Noise and Climate:</p> <p>NHEP32 Support the ‘National Climate Change Strategy’, (2007 – 2012) and all measures contained within this strategy that are implementable at a local level.</p> <p>NHEP33 Ensure the reduction of GHG emissions through the implementation of measures including: planning for compact settlements which accommodate sufficient lands for residential, industrial and commercial land uses in order to reduce trip generation making services more accessible and facilitating more sustainable means of travel.</p> <p>NHEP34 Ensure that all planning applications for developments which potentially cause noise pollution are subject to appropriate noise monitoring programmes. Potential noise-generating land uses and developments which are subject to the planning process will be assessed in terms of the ‘Environmental Noise Regulations’ (S.I. 140 of 2006). (p. 224)</p> |
| Recreation And Tourism | Policy and Objectives | <p>Section 9.5 of the Plan sets out the Waterways and Fisheries Policy:</p> <p>RTP1 Recognise and support the important contribution that angling makes to the leisure and tourist sector in the County whilst ensuring the protection of our Natural Heritage in line with chapter eight of this Plan.” (p. 232)</p> <p>Section 9.5 of the Plan sets out the Waterways and Fisheries Objectives:</p> <p>RTO1 Support and encourage the development of access and other infrastructure for angling including access for people with mobility issues.</p> <p>RTO2 Ensure the protection of existing angling locations and maintain free from inappropriate development.” (p. 232)</p> |

| CAVAN COUNTY DEVELOPMENT PLAN 2014 - 2020 | | |
|---|--------|--|
| POLICY TOPIC | POLICY | POLICY OBJECTIVE |
| | | <p>Section 9.6 of the Plan sets out the Walkways and Amenities Objectives</p> <p>“RTO3 To recognise the importance of walking and cycling routes and other countryside recreational opportunities, promote their development and ensure their protection, maintenance and where feasible improvement .</p> <p>RTO4 To protect areas of outstanding landscape, the natural and built environment and the cultural heritage that forms the County’s tourism resource.</p> <p>RTO5 To encourage and assist areas, where tourism is currently underdeveloped and there is a need for local tourism development initiatives to realise their full tourism potential in an environmentally sustainable manner.</p> <p>RTO6 To work in partnership with Fáilte Ireland, funders and other tourism organisations to promote and facilitate the provision of necessary infrastructure supports for the development of tourism.</p> <p>RTO7 To support and promote sustainable tourism through the encouragement of development that enhances as well as protects the County’s landscape and other elements of the natural and built heritage.</p> <p>RTO8 To improve existing Local Authority recreational and amenity facilities, and provide new facilities where considered necessary.</p> <p>RTO9 To facilitate the provision of tourist facilities in keeping with the Tourism Strategy and the protection of the environment.</p> <p>RTO10 To ensure the protection of and co-ordinate the continuing development of strategic walking routes, trails and other countryside recreational opportunities.</p> <p>RTO11 To further enhance the geodiversity, biodiversity and natural environment of the region including additional measures to conserve geosites and natural habitats where appropriate.</p> <p>RTO12 To facilitate opportunities for the social use of state forests and to enhance public enjoyment of the geology and natural landscapes of the region.</p> <p>RTO13 To promote and facilitate the redevelopment of the Ulster Canal and associated waterways</p> <p>RTO14 To promote and facilitate the opening of the waterway between Belturbet and Killeshandra.</p> <p>RTO15 To support those families wishing to remain on the land and by taking a favourable approach towards agri-tourism schemes and other enterprises intended to supplement farm income.</p> <p>RTO16 Develop tourism initiatives across the county and in particular the Cross-Border Global Geopark.</p> <p>RTO17 To investigate and facilitate, subject to resources, the re-use of railways lines for amenity and recreational purposes, and encourage their development as accessible walking and cycling routes</p> |

| CAVAN COUNTY DEVELOPMENT PLAN 2014 - 2020 | | |
|---|--------|--|
| POLICY TOPIC | POLICY | POLICY OBJECTIVE |
| | | <p>RTO18 Protect established walking and cycling routes and keep free from development which would adversely impact upon them and their use as walking and cycling routes.</p> <p>RTO19 Encourage and support the enhancement and extension of existing walking and cycling routes, by utilising links from residential areas, parks, open spaces and existing or new public rights of way to facilitate the creation of a secure, safe green network, to provide access to scenic, mountain, lakeshore and river features and views of special interest. To support, promote and encourage the development of walking and cycling routes, in conjunction with the Irish Sports Council, IW and Fáilte Ireland, which provide linkages with trails, particularly those with historical associations, in adjoining counties including cross border counties in partnership with their councils, the state, private and voluntary sectors.</p> <p>RTO20 To promote Walking and Cycling by securing the development of a network of safe cycle routes and footpaths on existing roads and on new road improvement schemes and on routes reserved exclusively for pedestrians and cyclists. To provide, improve and extend the network of cycle lanes and pedestrian routes on existing roads, on all new regional, local distributor and local collector roads and on roads being up-graded, to create a safer, more convenient and more user-friendly environment.</p> <p>RTO21 To ensure that in respect of proposed walking routes for the various settlements, the route selection process considers and assesses the potential for likely significant effects on the environment (including disturbance to species and habitats) in selecting a preferred route and states that where certain routes are adjacent to Natura 2000 sites, the requirements of the Habitats Directive should be taken into account.</p> <p>RTO22 To ensure that in the preparation of walking/cycling strategy for the County, potential effects (both positive and negative) on the environment should be taken into account for potential cumulative effects.(p. 235-237)</p> <p>Section 9.7 of the Plan sets out the Tourism Accommodation in Rural Locations Objectives:</p> <p>RTO23 Applications for new tourist accommodation shall submit details of existing tourist facilities in the area along with justification for the development. In rural areas the development of new tourist accommodation may not be suitable and strong justification is required. Along with general requirements including landscaping plans, site assessment and visual impact assessments, applicants and developers are required to establish the suitability of specific sites in the context of sustainability. All proposals in rural locations shall provide detailed analysis of a specific resource or attraction that is an existing or potential tourist attraction, along with justification for why the tourist accommodation is required including;</p> <ul style="list-style-type: none"> • Details of existing accommodation in the area. • Details of number of visitors to the identified tourist attraction. • Details of how the proposal relates to and reflects the identified attraction or resource. • How the design and scale of the proposal reflects its location and compliments the area. • Other such details as maybe required by the planning authority. |

| CAVAN COUNTY DEVELOPMENT PLAN 2014 - 2020 | | |
|---|--------|---|
| POLICY TOPIC | POLICY | POLICY OBJECTIVE |
| | | <ul style="list-style-type: none"> Proposals shall not be permitted where, in the opinion of the Planning Authority, the applicant has failed to provide strong justification. <p>RTO24 To ensure tourism proposals follow the principles of proper planning and sustainable development as per the policies and objectives of this plan.</p> <p>RTO25 To promote where possible the re-use and adoption of existing rural buildings if tourist accommodation is proposed outside existing settlements.</p> <p>RTO26 To promote the development of high quality tourist accommodation, especially hotels and guesthouses and self catering accommodation.</p> <p>RTO27 To ensure that all tourism related developments are of a high standard in terms of their design and landscaping. Applications for such developments shall demonstrate how the development will be assimilated into the landscape by siting, design and landscaping and how it will have no significant adverse impacts on natural, archaeological and built heritage features, landscapes, environmentally sensitive areas, scenic and visual amenities and should be appropriate to the character of the area.</p> <p>RTO28 To direct tourism based development, where appropriate, into existing settlements, where there is adequate infrastructure to service the development and where residents can contribute to the maintenance of essential rural services.</p> <p>RTO29 To ensure tourist related development is constructed in such a manner as to conserve and enhance the natural environment and therefore to serve the future of the tourist industry in the County without compromising its natural beauty.” (p. 237-239)</p> <p>Integrated Tourism/Recreational Complex Objective</p> <p>“RTO30 To promote the continued sustainable development of Integrated Tourism/Recreational Complex’s throughout the County as important generators of tourist and economic activities.” (p.240)</p> |

MEATH COUNTY DEVELOPMENT PLAN 2013 - 2019

DRAFT

| MEATH COUNTY DEVELOPMENT PLAN 2013-2019 | | |
|---|-------------------------------|---|
| POLICY TOPIC | POLICY | POLICY OBJECTIVE |
| Core Strategy | Development Plan Vision | <p>The Development Plan Vision is as follows:</p> <p><i>“Meath to be a county that fosters sustainability throughout its vibrant communities, dynamic economy and unique cultural and natural heritage”.</i> (p. 11)</p> <p>This vision is supplemented by a series of core principles including:</p> <p>“Core Principle 11 To integrate climate change considerations into the policies and objectives of Meath County Council and its key stakeholders”. (p. 12)</p> |
| Core Strategy | Sustainable Heritage | <p>Goals:</p> <ul style="list-style-type: none"> • <i>“To ensure that the unique cultural heritage of Meath is protected, conserved, enhanced and sensitively integrated into the sustainable development of the county for the benefit of present and future generations.</i> • <i>To ensure that features of Meath’s natural heritage and green infrastructure that provide ecosystem services are protected and that tourist and recreational uses are facilitated in a sustainable manner.</i> • <i>To protect the landscape character, quality and local distinctiveness of County Meath”</i> (p.31) |
| Economic Development | Economic Development Strategy | <p>Goal:</p> <p><i>“To build on and enhance the competitiveness and attractiveness of County Meath in order to make it one of Ireland’s prime locations for indigenous and foreign economic and employment generating investment.”</i> (p. 74)</p> <p>The Plan states that it is a policy of Meath County Council:</p> <p>“ED POL 15 To recognise and develop the full potential of biomass for energy production and manufacturing including the export of green electricity to the national grid. The Development Plan acknowledges that such enterprises are more readily accommodated in rural areas due to the extent of lands required to ensure security of supply of raw materials and that proximity to the medium to high voltage national electricity transmission network for green electricity exportation is a key locational consideration for development proposers. All proposals for biomass energy production and manufacturing will require screening to determine if a full Appropriate Assessment of the likely significant effects on Natura 2000 sites, is required.” (p. 91)</p> <p>“ED POL 29 To protect and conserve those natural, built and cultural heritage features that form the basis of the county’s tourism attraction and to seek to restrict development which would be detrimental to scenic and identified</p> |

| MEATH COUNTY DEVELOPMENT PLAN 2013-2019 | | |
|---|-------------------------|---|
| POLICY TOPIC | POLICY | POLICY OBJECTIVE |
| | | <p><i>natural and cultural heritage assets". (p. 105)</i></p> <p><i>"ED POL 46 To have regard to the advice of the Health & Safety Authority when proposals for development within the consultation zone of a SEVESO site are being considered." (p. 109)</i></p> |
| Transportation | Transportation Strategy | <p>Goal:</p> <p><i>"To promote and facilitate the provision of the necessary transport infrastructure to fully accommodate existing and future population needs as well as the demand for economic development in an environmentally sustainable manner". (p. 138)</i></p> <p>Objectives:</p> <p><i>"TRAN OBJ 1 To protect and safeguard the detailed designed alignment of Phase II of the Navan rail route and surrounding lands (including identified station locations), as illustrated on Map Series No. 6.2 in Volume 3, free from development and any encroachment by inappropriate uses which could compromise its future development as a rail facility. Land Use Zoning Objective R1 Rail Corridor also refers". (p.148)</i></p> <p><i>"TRAN OBJ 2 To facilitate and encourage the upgrading of existing railway stations, and protect as required lands required for the upgrading of existing railway lines or stations or the provision of new railway stations throughout the County. Any such proposals for developments in Bettystown and south of Drogheda, will have to ensure that there are no adverse effects on integrity of SPAs". (p. 148)</i></p> <p><i>"TRAN OBJ 17 To support, where appropriate, major road improvements, bypasses of local towns and villages and proposed national road schemes by reserving the corridors of any such proposed routes free of developments, which would interfere with the provision of such proposals. Such road schemes include:</i></p> <p>Scheme Name - Description of Works</p> <p><i>N2 Slane By-pass: N2 Slane Bypass incorporating new bridge over the River Boyne.</i></p> <p><i>N2 Rath Roundabout to Kilmoon Cross: Investigate and progress online upgrading of this section of the National Primary Route.</i></p> <p><i>M3 Junction 4: Upgrading of this junction to improve capacity.</i></p> <p><i>M1 Junction 7: Possible upgrading of this junction to improve capacity inclusive of the facilitation of vehicular access to / from Stamullen via the City North Business Campus to the M1 Interchange.</i></p> <p><i>M1 Junction 8: Possible upgrading of this junction to improve capacity.</i></p> <p><i>M1 Junction 9: Possible upgrading of this junction to improve capacity.</i></p> |

| MEATH COUNTY DEVELOPMENT PLAN 2013-2019 | | |
|---|--------|---|
| POLICY TOPIC | POLICY | POLICY OBJECTIVE |
| | | <p><i>M3 Junction 5: Possible upgrading of this junction to improve capacity.</i></p> <p><i>M3 Junction 9: Possible upgrading of this junction to improve capacity.</i></p> <p><i>N2 Rath Roundabout: Possible upgrading of this junction to improve capacity.</i></p> <p><i>M3 South of Junction 4: Introduce an additional lane on both M3 carriageways in co-operation with planned M3 upgrades with Fingal County Council and the National Roads Authority.</i></p> <p><i>N52 Fringestown: Re-alignment of approximately 3km of the existing N52.</i></p> <p><i>N51 Dunmoe: Realignment of N51 between Dunmoe and Cruicetown.</i></p> <p><i>N51 Halltown: Construction of junction improvement and re-alignment of minor roads.</i></p> <p><i>N51/R164 Junction: Re-alignment of N51 and amendment of junction arrangement to give priority to National Road Traffic.</i></p> <p><i>N51 Slane to Louth County boundary: Re-alignment including widening of Mattock Bridge, and junction improvements.</i></p> <p><i>N52/R162 Junction: Re-alignment of N52 and amendment of junction arrangement to give priority to National Road Traffic. Including re-alignment necessary to remove height restriction at crossing of Navan - Kingscourt Railway.</i></p> <p><i>N52/R154 Junction: Improve junction and re-align regional road to introduce a staggered arrangement.</i></p> <p><i>N52 Balrath Junction: Re-align N52 and improve junction layout.</i></p> <p><i>Local Bypasses/Relief Roads Examine feasibility and progress where appropriate local bypass and relief roads as indicated on Map No. 6.3 and identified in Local Area Plans and Town Development Plans.</i></p> <p><i>NB: The above list is for guidance purposes. It is not exhaustive, and other schemes may be advanced during the lifetime of the plan and at the discretion of the Council in consultation with relevant agencies.” (p.159)</i></p> <p><i>“TRAN OBJ 21 To co-operate with the NRA, NTA and other Local Authorities in clarifying and finalising the route of the Leinster Outer Orbital Route (linking Drogheda, Navan, Trim and Naas) proposed in the ‘Regional Planning Guidelines for the Greater Dublin Area’ and the NTA’s draft Transport Strategy. This is particularly important in the vicinity of proposed major junctions along the route in order to protect the identified corridor from development intrusion.” (p. 160)</i></p> |
| Energy and Communications | Energy | <p>Policies:</p> <p><i>“EC POL 1 To facilitate energy infrastructure provision, including the development of renewable energy sources at suitable locations, so as to provide for the further physical and economic development of Meath.</i></p> |

| MEATH COUNTY DEVELOPMENT PLAN 2013-2019 | | |
|---|--------|---|
| POLICY TOPIC | POLICY | POLICY OBJECTIVE |
| | | <p>EC POL 2 To support international, national and county initiatives for limiting emissions of greenhouse gases through energy efficiency and the development of renewable energy sources which makes use of the natural resources of the county in an environmentally acceptable manner, where it is consistent with proper planning and sustainable development of the area. EC POL 3 To encourage the production of energy from renewable sources, such as from biomass, waste material, solar, wave, hydro, geothermal and wind energy, subject to normal proper planning considerations, including in particular, the potential impact on areas of environmental or landscape sensitivity and Natura 2000 sites.</p> <p>EC POL 4 To support the National Climate Change Strategy and, in general, to facilitate measures which seek to reduce emissions of greenhouse gases.</p> <p>EC POL 11 To support and facilitate the development of enhanced electricity and gas supplies, and associated networks, to serve the existing and future needs of the County.</p> <p>EC POL 12 To co-operate and liaise with statutory and other energy providers in relation to power generation in order to ensure adequate power capacity for the existing and future needs of the County.</p> <p>EC POL 13 To ensure that energy transmission infrastructure follows best practice with regard to siting and design particularly to ensure the protection of all important recognised landscapes.</p> <p>EC POL 16 To require that the location of local energy services such as electricity, be underground, where possible.</p> <p>EC POL 17 To seek to avoid the sterilisation of lands proximate to key public transport corridors such as rail, where future energy transmission routes/pipelines are being designed and provided.</p> <p>EC POL 18 To generally avoid the location of overhead lines in Natura 2000 sites unless it can be proven that they will not affect the integrity of the site in view of its conservation objectives i.e. by carrying out an appropriate assessment in accordance with Article 6(3) of the E.C. Habitats Directive.</p> <p>EC POL 19 To promote the undergrounding of existing overhead cables and associated equipment where appropriate.” (p. 199-201)</p> <p>Objectives:</p> <p>“EC OBJ 1 To ensure that all plans and projects associated with the generation or supply of energy or telecommunication networks will be subject to an Appropriate Assessment Screening and those plans or projects which could, either individually or in-combination with other plans and projects, have a significant effect on a Natura 2000 site (or sites) undergo a full Appropriate Assessment.</p> |

| MEATH COUNTY DEVELOPMENT PLAN 2013-2019 | | |
|---|--------------------------|--|
| POLICY TOPIC | POLICY | POLICY OBJECTIVE |
| | | <p>EC OBJ 3 To investigate the preparation of a renewable energy strategy promoting technologies which are most viable in County Meath.</p> <p>EC OBJ 4 To seek the delivery of the necessary integration of transmission network requirements to facilitate linkages of renewable energy proposals to the electricity transmission grid in a sustainable and timely manner". (p. 202)</p> |
| Cultural and Natural Assets | Key Challenges | <p>"The key challenge for the period of this Development Plan is to:</p> <ul style="list-style-type: none"> • achieve the balance between protecting, conserving and presenting the county's rich cultural and natural heritage while promoting sustainable economic development and the enrichment of the environment. (p. 210) <p>Strategic Policies:</p> <p>"CSA SP 1 To ensure that the unique cultural heritage of Meath is protected, conserved and sensitively integrated into the sustainable development of the county for the benefit of present and future generations.</p> <p>CSA SP 2 To ensure that features of Meath's natural heritage and green infrastructure that provide ecosystem services are protected; that biodiversity is conserved and where possible enhanced, and; that the character of landscapes are maintained and enriched, and that tourist and recreational uses are facilitated in a sensitive manner.</p> <p>CSA SP 3 To promote the understanding of County Meath's landscape in terms of its inherent and unique character and to recognise what elements should be preserved, conserved or enhanced".(p.210)</p> |
| Cultural and Natural Assets | Cultural Heritage | <p>Development in the Brú na Bóinne UNESCO World Heritage Site</p> <p>Policies:</p> <p>"CH POL 1 To work in partnership with the relevant agencies / organisations and the public to promote, understand, conserve and sustainably manage the UNESCO World Heritage Site of Brú na Bóinne.</p> <p>CH POL 3 To require that all development within the UNESCO World Heritage site of Brú na Bóinne shall be subject to the Development Assessment Criteria set out in Volume 1, Chapter 9, Section 9.6.7, and elsewhere in the Development Plan.</p> <p>CH POL 4 To refer all planning applications within the UNESCO World Heritage Site of Brú na Bóinne to the Department of Arts, Heritage and the Gaeltacht for comment. These comments will be considered in the making of decisions on all such planning applications." (p. 214)</p> |

| MEATH COUNTY DEVELOPMENT PLAN 2013-2019 | | |
|---|--------|---|
| POLICY TOPIC | POLICY | POLICY OBJECTIVE |
| | | <p>Objectives:</p> <p><i>“CH OBJ 1 To protect and enhance the Outstanding Universal Value of the cultural landscape in the UNESCO World Heritage Site of Brú na Bóinne in accordance with the relevant guidelines and national legislation, so that its integrity, authenticity and significance are not adversely affected by cumulative inappropriate change and development, and to enhance views within and adjacent to the site.</i></p> <p><i>CH OBJ 2 To protect the ridgelines which frame views within and from the UNESCO World Heritage Site of Brú na Bóinne from inappropriate or visually intrusive development.</i></p> <p><i>CH OBJ 3 To encourage and facilitate pre-planning consultation with applicants regarding the siting and design of developments affecting the UNESCO World Heritage Site of Brú na Bóinne, and the scope of any necessary impact assessments” (p. 214)</i></p> <p>World Heritage Tentative List</p> <p>Policy:</p> <p><i>“CH POL 5 To recognise and respect potential World Heritage Sites in Meath on the UNESCO Tentative List – Ireland-2010 and support their nomination to World Heritage status.</i></p> <p><i>CH POL 6 To promote awareness of, and access to, the archaeological inheritance of County Meath.</i></p> <p><i>CH POL 7 To ensure that development in the immediate vicinity of a recorded monument is sensitively sited and designed so that it does not significantly detract from the monument. Where upstanding remains exist, a visual impact assessment may be required.</i></p> <p><i>CH POL 9 To inform and seek guidance from the National Museum of Ireland if an unrecorded archaeological object is discovered, or the National Monuments Service of the Department of Arts, Heritage and the Gaeltacht in the case of the discovery of an unrecorded archaeological site, in accordance with National Monuments legislation”. (p. 217-218)</i></p> <p>Objectives:</p> <p><i>“CH OBJ 7 To protect archaeological sites and monuments, underwater archaeology, and archaeological objects, which are listed in the Record of Monuments and Places, and to seek their preservation in situ (or at a minimum, preservation by record) through the planning process.</i></p> <p><i>CH OBJ 8 To seek to protect important archaeological landscapes from inappropriate development.</i></p> |

| MEATH COUNTY DEVELOPMENT PLAN 2013-2019 | | |
|---|-------------------------|---|
| POLICY TOPIC | POLICY | POLICY OBJECTIVE |
| | | <p>CH OBJ 11 To encourage and promote the appropriate management and maintenance of the County's archaeological heritage, including historical burial grounds, in accordance with conservation principles and best practice guidelines." (p. 218-219)</p> <p>Architectural Heritage –Record of Protected Structures Policy: "CH POL 10 To preserve and protect the architectural heritage of Meath". (p. 220)</p> <p>Architectural Conservation Areas Policy: "CH POL 18 To require that all development proposals within an ACA should be appropriate to the character of the area, inclusive of its general scale and materials, and are appropriately sited and sensitively designed having regard to the advice given in the Statements of Character for each area." (p. 223)</p> <p>Objective "CH OBJ 21 To ensure that any new development within or contiguous to an ACA is sympathetic to the character of the area and that the design is appropriate in terms of scale, height, plot density, layout, materials and finishes". (p. 223)</p> <p>Designed Landscapes, Historic Parks, Gardens and Demesnes Objectives: "CH OBJ 22 To discourage development that would lead to a loss of, or cause damage to, the character, the principal components of, or the setting of historic parks, gardens and demesnes of heritage significance. CH OBJ 23 To require that proposals for development in designed landscapes and demesnes include an appraisal of the landscape, designed views and vistas, and an assessment of significant trees or groups of trees, as appropriate." (p.224) [NOTE: See Variation No. 2 below for amended policy]</p> |
| Cultural and Natural Assets | Natural Heritage | <p>Policies: "NH POL 1 To protect, conserve and seek to enhance the County's biodiversity. "NH POL 2 To promote measures to protect biodiversity in the development management process by creating and improving habitats, where possible.</p> |

| MEATH COUNTY DEVELOPMENT PLAN 2013-2019 | | |
|---|--------|---|
| POLICY TOPIC | POLICY | POLICY OBJECTIVE |
| | | <p>NH POL 5 To permit development on or adjacent to designated Special Areas of Conservation, Special Protection Areas, National Heritage Area or those proposed to be designated over the period of the plan, only where an assessment carried out to the satisfaction of the Meath County Council, in consultation with National Parks and Wildlife Service, indicates that it will have no significant adverse effect on the integrity of the site.</p> <p>NH POL 6 To have regard to the views and guidance of the National Parks and Wildlife Service in respect of proposed development where there is a possibility that such development may have an impact on a designated European or National site or a site proposed for such designation". (p. 226-228)</p> <p>Objectives:</p> <p>"NH OBJ 2 To ensure an Appropriate Assessment in accordance with Article 6(3) and Article 6(4) of the Habitats Directive, and in accordance with the Department of Environment, Heritage and Local Government Appropriate Assessment of Plans and Projects in Ireland – Guidance for Planning Authorities, 2009 and relevant EPA and European Commission guidance documents, is carried out in respect of any plan or project not directly connected with or necessary to the management of the site but likely to have a significant effect on a Natura 2000 site(s), either individually or in-combination with other plans or projects, in view of the site's conservation objectives.</p> <p>NH OBJ 3 To protect and conserve the conservation value of candidate Special Areas of Conservation, Special Protection Areas, National Heritage Areas and Proposed National Heritage Areas as identified by the Minister for the Department of Arts, Heritage and the Gaeltacht and any other sites that may be proposed for designation during the lifetime of this Plan". (p.228)</p> <p>Protected Species</p> <p>Policies:</p> <p>"NH POL 8 To seek to ensure that development does not have a significant adverse impact, incapable of satisfactory avoidance or mitigation, on plant, animal or bird species protected by law.</p> <p>NH POL 9 To consult with the National Parks and Wildlife Service, and take account of any licensing requirements, when undertaking, approving or authorising development which is likely to affect plant, animal or bird species protected by law." (p. 231)</p> <p>Peatlands</p> <p>Policy:</p> <p>"NH POL 11 To seek to ensure that peatland areas which are designated (or proposed for designation) as NHAs, SACs or SPAs are conserved for their ecological, archaeological, cultural and educational significance". (p. 232)</p> |

| MEATH COUNTY DEVELOPMENT PLAN 2013-2019 | | |
|---|--------|--|
| POLICY TOPIC | POLICY | POLICY OBJECTIVE |
| | | <p>Geological Heritage</p> <p>Policy:</p> <p><i>“NH POL 12 To have regard to the geological and geomorphological heritage values of County Geological Sites listed in Appendix 13 and avoid inappropriate development through consultation with the Geological Survey of Ireland”. (p. 232)</i></p> <p>Woodlands, Hedgerows and Trees</p> <p>Policy:</p> <p><i>“NH POL 13 To encourage the retention of hedgerows and other distinctive boundary treatments in rural areas and prevent loss and fragmentation, where possible. Where removal of a hedgerow, stone wall or other distinctive boundary treatment is unavoidable, mitigation by provision of the same type of boundary will be required.</i></p> <p><i>NH POL 15 To recognise the archaeological importance of townland boundaries including hedgerows and promote their protection and retention.”</i></p> <p><i>“NH POL 16 To seek to maintain the natural heritage and amenity of the county by promoting the preservation and enhancement of native and semi-natural woodlands, groups of trees and individual trees.</i></p> <p><i>NH POL 18 To encourage the retention of mature trees and the use of tree surgery rather than felling where possible when undertaking, approving or authorising development.</i></p> <p><i>NH POL 19 To protect Champion and Heritage Trees identified on the Tree Register of Ireland and Heritage Tree Database when undertaking, approving or authorising development.” (p. 223-234)</i></p> <p>Public Rights of Way</p> <p>Policy:</p> <p><i>“NH POL 20 To preserve and protect for the common good, existing public rights of way which give access to seashore, mountain, lakeshore, riverbank or other place of natural beauty or recreational utility as identified in Appendix 14 & Map Series 9.4 (Volume III)”. (p. 235)</i></p> <p>Objective:</p> <p><i>“NH OBJ 8 To seek to identify and protect over the lifetime of the plan further existing rights of way which give access to seashore, mountain, lakeshore, riverbank or other place of natural beauty or recreational utility</i></p> |

| MEATH COUNTY DEVELOPMENT PLAN 2013-2019 | | |
|---|--------------------------------|---|
| POLICY TOPIC | POLICY | POLICY OBJECTIVE |
| | | <p>(accompanied by mapping showing public rights of way).” (p. 235)</p> <p>Landscape Character Assessment</p> <p>Strategic Policy:</p> <p>“LC SP 1 To protect the landscape character, quality and local distinctiveness of County Meath in accordance with relevant government policy and guidelines and the recommendations included in Meath Landscape Character Assessment (2007) in Appendix 7.” (p. 239)</p> <p>Policy:</p> <p>“LC POL 2 To require that any necessary assessments, including landscape and visual impact assessments, are provided when undertaking, authorising or approving development.” (p. 239)</p> <p>Objectives:</p> <p>“LC OBJ 1 To seek to ensure the preservation of the uniqueness of all landscape character types, and to maintain the visual integrity of areas of exceptional value and high sensitivity.</p> <p>LC OBJ 2 To assess development proposals having regard to the recommendations contained in the Meath Landscape Character Assessment 2007.” (p. 239)</p> <p>Views and Prospects</p> <p>Objective:</p> <p>“LC OBJ 5 To preserve the views and prospects and the amenity of places and features of natural beauty or interest listed in Appendix 12 and shown on Map 9.5.1 from development that would interfere with the character and visual amenity of the landscape.” (p. 240)</p> <p>Landscape Conservation Area(s)</p> <p>Policy:</p> <p>“LC POL 3 To protect the archaeological heritage, rural character, setting and amenity of the Tara landscape and Loughcrew and Slieve na Calliagh Hills.” (p. 242)</p> |
| Rural Development | Goal and Strategic Development | <p>Goal:</p> <p>“To encourage the continued sustainable development of rural communities without compromising the physical,</p> |

| MEATH COUNTY DEVELOPMENT PLAN 2013-2019 | | |
|--|---------------------|--|
| POLICY TOPIC | POLICY | POLICY OBJECTIVE |
| | | <p><i>environmental, natural and heritage resources of the County” (p. 244)</i></p> <p>Strategic Objectives:</p> <p><i>“RUR DEV SO 3 To identify and protect known or potential aggregate resources, where feasible, from development which would prejudice their sustainable future usage.</i></p> <p><i>RUR DEV SO 6 To protect and enhance the visual qualities of rural areas through sensitive design.</i></p> <p><i>RUR DEV SO 9 To ensure that plans and projects associated with rural development will be subject to an Appropriate Assessment Screening and those plans or projects which could, either individually or in-combination with other plans and projects, have a significant effect on a Natura 2000 site (or sites) undergo a full Appropriate Assessment.” (p. 244-245)</i></p> |
| Rural Development | Roadside boundaries | <p>Policy:</p> <p><i>“RD POL 41 To avoid the removal of existing roadside boundaries where they are more than 3 meters from the road edge (edge of carriageway), except to the extent that this is needed for a new entrance, and where required for traffic safety reasons. (Please refer to policies contained in Section 9.7.8 Woodlands, Hedgerows and Trees in this regard)” (p. 268)</i></p> |
| <p>Variation No. 1 (adopted 4/112013) Variation No. 2 (adopted 19/52014) – relevant variations to Volume 1 (Written Statement) - see below [NOTE Variation No. 2 contains a number of LAP’s]</p> | | |
| Variation No. 1 - relates to the preparation of LAP’s, and residential development | | <p>Objective:</p> <p><i>“CS OBJ 7 To promote and facilitate the development of sustainable communities through land use planning, by providing for land uses capable of accommodating employment, community, leisure, recreational and cultural facilities having regard to the quality of the environment, including the natural environment, landscape character and the archaeological and architectural heritage”</i></p> |
| Variation No. 2 - insertion of new policy: Cultural and Natural Assets | | <p>Policy:</p> <p><i>“NH POL 26 To require that development proposal, on both designated and undesignated sites, enhance and appropriately integrate with the natural environment, respecting and complementing the habitats, biodiversity, landscape and natural heritage of the area.”</i></p> |

| MEATH COUNTY DEVELOPMENT PLAN 2013-2019 | | |
|---|--------|---|
| POLICY TOPIC | POLICY | POLICY OBJECTIVE |
| <p>Variation No. 2 - Amendment of Existing Objective (section 9.6.13 – Designed Lands, Historic Parks, Gardens and Demesnes)</p> | | <p>CH OBJ 23 <i>To require that proposals for development in and adjoining designed landscapes and demesnes include an appraisal of the landscape, designed views and vistas, and an assessment of significant trees or groups of trees, as appropriate. The appraisal shall ensure that development proposals respect and are consistent with the historic landscape and its protection. Any development within such areas shall comply with the policies and objectives of 'Architectural Heritage Protection, Guidelines for Planning Authorities' (2011), as appropriate." (p.224)</i></p> |

DRAFT

APPENDIX 6

Research References - High Voltage Overhead Line Infrastructure and Property Values

DRAFT

DRAFT

Bond, S. and Hopkins, J (2002). *The Impact of Transmission Lines on Residential Property Values: Results of a Case Study*. Pacific Rim Property Research Journal, Vol. 6, No. 2, p. 52-60.

Chalmers, J.A and Voorvaart, F.A (2009). *High-Voltage Transmission Lines: Proximity, Visibility, and Encumbrance Effects*. The Appraisal Journal, 2009, Summer, p. 227–45.

Colwell, P.F (1990). *Power Lines & Land Value*. Journal of Real Estate Research, 1990, 5:1, p. 117–27.

Colwell, P. F and Foley, K. W (1979). *Electric Transmission Lines and the Selling Price of Residential Property*. The Appraisal Journal, 1979, 47:4, p. 490-99.

Delaney, C.J. and Timmons, D (1992). *High Voltage Power Lines: Do they affect Residential Property Value*. Journal of Real Estate Research, 1992, 7:3, p. 315–29.

Des Rosiers, F (1998). *High Voltage Transmission Lines and Property Values: A Microspatial Approach to Impact Measurement*.

Des Rosiers, F (2002). *Power Lines, Visual Encumbrance and House Values: A Microspatial Approach to Impact Measurement*. Journal of Real Estate Research, 2002, 23:3, p. 275–301.

Furby, L., Gregory, R., Slovic, P. and Fischhoff, B (1988). *Electric Power Transmission Lines, Property Values and Compensation*. Journal of Environmental Management, 1998, 27, p. 69-83.

Gallimore, P. and Jayne. M. R (1997). *Public and Professional Perception of HVOTL Risks: Avoiding Circularity*, Journal of Property Research, Volume 16, Issue 3, 1999, p. 243-55.

Hamilton, S.W. and Schwann, G.M (1995). *Do High Voltage Electric Transmission Lines Affect Property Value?* Land Economics, November 1995, 71(4), p. 436-44.

Isnelzi, P.C. & Priestley, T (1991). *A Statistical Analysis of Transmission Line Impacts on Residential Property Values in Six Neighbourhoods*. Southern California Edison Environmental Affairs Division; San Francisco.

Jackson, T. O. (2010) *Electric Transmission Lines: Is there an impact on Rural Land Values*. Right of Way, 2010, November / December.

Jackson, T.O. & Pitts, J.M (2010). *The Effects of Electric Transmission Lines on Property Values: A Literature Review*. The Journal of Real Estate Literature, Volume 18, Number 2/2102, pp. 239-59

Kinnard, William N. Jr. CRE, and Sue Ann Dickey (1995). *A Primer on Proximity Impact Research: Residential Property Values near High-Voltage Transmission Lines*

Kroll, C.A. & Priestley, T (1992). *The Effects of Overhead Transmission Lines on Property Values: A Review & Analysis of the Literature*. Report prepared for The Edison Electric Institute - Siting and Environmental Planning Task Force.

Rigdon, Glenn J, (1991). *138 kV Transmission Lines and the value of Recreational Land*. Right of Way, December 1991, p. 8-19.

Pitts, J. & Jackson, T.O (2007). *Power Lines & Property Values Revisited*. The Appraiser Journal, Fall 2007, p 323 – 25.

Sims, S. & Dent, P (2005). *High-voltage Overhead Power Lines and Property Values: A Residential Study in the UK*. Urban Studies, Vol. 24, No.4, p665-695, April 2005.

Wolverton, M.L. & Bottemiller, S.C (2003). *Further Analysis of Transmission Line Impact on Residential Property Values*, The Appraisal Journal, 2003, Volume 31:3.

DRAFT